

ML2597 - Brooklands Sports Club - Hockey

MIDSTREAM LED PROPOSAL

REV05

5 x 16m Poles

1 x 15m Poles

Maintenance Factor: 0.9

- Full Pitch:

Total Floodlights:

20 x Modus S1500 NS (5000K)

04 x Modus S1500 WS (5000K)

Total Power Installed: 36 kW

Lighting Requirements: Eav=500 Lux; Emin/Eav=0.7

Calculated Values: Eav=500+ Lux; Emin/Eav>0.7

Calculated Values are guaranteed for a 10 x 6 grid points (FIH) as shown in the following calculation

- Half Pitch 1 & Half Pitch 2:

Total Floodlights: 10 x Modus S1500 NS (5000K) on each Half

02 x Modus S1500 WS (5000K) on each Half

Total Power Installed: 18 kW on each Half

Lighting Requirements: Eav=350 Lux; Emin/Eav=0.7

Calculated Values: Eav=350+ Lux; Emin/Eav>0.7

Calculated Values are guaranteed for a 5 x 6 grid points as shown in the following calculation

- Dimming Full Pitch to Eav=350 lux

Date: 18.06.2024

Operator: MIDSTREAM LIGHTING LIMITED

MIDSTREAM LIGHTING LIMITED
 WESSEX HOUSE
 1 CHESHAM STREET
 LONDON, SW 1X 8ND, UNITED KINGDOM

Operator MIDSTREAM LIGHTING LIMITED
 Telephone +44 (0)207 584 8310
 Fax
 e-Mail info@midstreamlighting.com

Table of contents

ML2597 - Brooklands Sports Club	
Project Cover	1
Table of contents	2
MIDSTREAM - Modus S1500 WS (5000K)	
Luminaire Data Sheet	10
MIDSTREAM - Modus S1500 NS (5000K)	
Luminaire Data Sheet	11
Full Pitch	
Planning data	12
Luminaire parts list	13
Luminaires (layout plan)	14
Luminaires (coordinates list)	15
GR Observer (Results Overview)	17
3D Rendering	20
False Color Rendering	21
Exterior Surfaces	
Hockey Pitch Calculation Grid	
Summary	22
Isolines (E, Horizontal)	23
Greyscale (E, Horizontal)	24
Value Chart (E, Horizontal)	25
Spill Out - House 1	
Table (E, Perpendicular)	26
Spill Out - House 2	
Table (E, Perpendicular)	27
Spill Out - House 3	
Table (E, Perpendicular)	28
Spill Out - House 4	
Table (E, Perpendicular)	29
Spill Out - House 5	
Table (E, Perpendicular)	30
Spill Out - House 6	
Table (E, Perpendicular)	31
Spill Out - House 7	
Table (E, Perpendicular)	32
Spill Out - House 8	
Table (E, Perpendicular)	33
Spill Out - House 9	
Table (E, Perpendicular)	34
Spill Out - House 10	
Table (E, Perpendicular)	35
Spill Out - House 11	
Table (E, Perpendicular)	36
Spill Out - House 12	
Table (E, Perpendicular)	37
Spill Out - House 13	
Table (E, Perpendicular)	38
Spill Out - House 14	
Table (E, Perpendicular)	39
Spill Out - House 15	
Table (E, Perpendicular)	40
Spill Out - House 16	
Table (E, Perpendicular)	41
Spill Out - House 17	

MIDSTREAM LIGHTING LIMITED
 WESSEX HOUSE
 1 CHESHAM STREET
 LONDON, SW 1X 8ND, UNITED KINGDOM

Operator MIDSTREAM LIGHTING LIMITED
 Telephone +44 (0)207 584 8310
 Fax
 e-Mail info@midstreamlighting.com

Table of contents

Table (E, Perpendicular)	42
Spill Out - House 18	
Table (E, Perpendicular)	43
Spill Out - House 19	
Table (E, Perpendicular)	44
Spill Out - House 20	
Table (E, Perpendicular)	45
Spill Out - House 21	
Table (E, Perpendicular)	46
Spill Out - House 22	
Table (E, Perpendicular)	47
Spill Out - House 23	
Table (E, Perpendicular)	48
Spill Out - House 24	
Table (E, Perpendicular)	49
Spill Out - House 25	
Table (E, Perpendicular)	50
Spill Out - House 26	
Table (E, Perpendicular)	51
Spill Out - House 27	
Table (E, Perpendicular)	52
Spill Out - House 28	
Table (E, Perpendicular)	53
Spill Out - House 29	
Table (E, Perpendicular)	54
Spill Out - House 30	
Table (E, Perpendicular)	55
Spill Out - House 31	
Table (E, Perpendicular)	56
Spill Out - House 32	
Table (E, Perpendicular)	57
Spill Out - House 33	
Table (E, Perpendicular)	58
Spill Out - House 34	
Table (E, Perpendicular)	59
Spill Out - House 35	
Table (E, Perpendicular)	60
Spill Out - House 36	
Table (E, Perpendicular)	61
Spill Out - House 37	
Table (E, Perpendicular)	62
Spill Out - House 38	
Table (E, Perpendicular)	63
Spill Out - House 39	
Table (E, Perpendicular)	64
Spill Out - House 40	
Table (E, Perpendicular)	65
Spill Out - House 41	
Table (E, Perpendicular)	66
Spill Out - House 42	
Table (E, Perpendicular)	67
Spill Out - House 43	
Table (E, Perpendicular)	68

Half Pitch 1

MIDSTREAM LIGHTING LIMITED
 WESSEX HOUSE
 1 CHESHAM STREET
 LONDON, SW 1X 8ND, UNITED KINGDOM

Operator MIDSTREAM LIGHTING LIMITED
 Telephone +44 (0)207 584 8310
 Fax
 e-Mail info@midstreamlighting.com

Table of contents

Planning data	69
Luminaire parts list	70
Luminaires (layout plan)	71
Luminaires (coordinates list)	72
GR Observer (Results Overview)	74
3D Rendering	77
False Color Rendering	78
Exterior Surfaces	
Half Pitch 1	
Summary	79
Value Chart (E, Horizontal)	80
Spill Out - House 1	
Table (E, Perpendicular)	81
Spill Out - House 2	
Table (E, Perpendicular)	82
Spill Out - House 3	
Table (E, Perpendicular)	83
Spill Out - House 4	
Table (E, Perpendicular)	84
Spill Out - House 5	
Table (E, Perpendicular)	85
Spill Out - House 6	
Table (E, Perpendicular)	86
Spill Out - House 7	
Table (E, Perpendicular)	87
Spill Out - House 8	
Table (E, Perpendicular)	88
Spill Out - House 9	
Table (E, Perpendicular)	89
Spill Out - House 10	
Table (E, Perpendicular)	90
Spill Out - House 11	
Table (E, Perpendicular)	91
Spill Out - House 12	
Table (E, Perpendicular)	92
Spill Out - House 13	
Table (E, Perpendicular)	93
Spill Out - House 14	
Table (E, Perpendicular)	94
Spill Out - House 15	
Table (E, Perpendicular)	95
Spill Out - House 16	
Table (E, Perpendicular)	96
Spill Out - House 18	
Table (E, Perpendicular)	97
Spill Out - House 19	
Table (E, Perpendicular)	98
Spill Out - House 20	
Table (E, Perpendicular)	99
Spill Out - House 21	
Table (E, Perpendicular)	100
Spill Out - House 22	
Table (E, Perpendicular)	101
Spill Out - House 23	

MIDSTREAM LIGHTING LIMITED
 WESSEX HOUSE
 1 CHESHAM STREET
 LONDON, SW 1X 8ND, UNITED KINGDOM

Operator MIDSTREAM LIGHTING LIMITED
 Telephone +44 (0)207 584 8310
 Fax
 e-Mail info@midstreamlighting.com

Table of contents

Table (E, Perpendicular)	102
Spill Out - House 24	
Table (E, Perpendicular)	103
Spill Out - House 25	
Table (E, Perpendicular)	104
Spill Out - House 26	
Table (E, Perpendicular)	105
Spill Out - House 27	
Table (E, Perpendicular)	106
Spill Out - House 28	
Table (E, Perpendicular)	107
Spill Out - House 29	
Table (E, Perpendicular)	108
Spill Out - House 30	
Table (E, Perpendicular)	109
Spill Out - House 31	
Table (E, Perpendicular)	110
Spill Out - House 32	
Table (E, Perpendicular)	111
Spill Out - House 33	
Table (E, Perpendicular)	112
Spill Out - House 34	
Table (E, Perpendicular)	113
Spill Out - House 35	
Table (E, Perpendicular)	114
Spill Out - House 37	
Table (E, Perpendicular)	115
Spill Out - House 38	
Table (E, Perpendicular)	116
Spill Out - House 39	
Table (E, Perpendicular)	117
Spill Out - House 40	
Table (E, Perpendicular)	118
Spill Out - House 41	
Table (E, Perpendicular)	119
Spill Out - House 42	
Table (E, Perpendicular)	120
Spill Out - House 43	
Table (E, Perpendicular)	121
Half Pitch 2	
Planning data	122
Luminaire parts list	123
Luminaires (layout plan)	124
Luminaires (coordinates list)	125
GR Observer (Results Overview)	127
3D Rendering	130
False Color Rendering	131
Exterior Surfaces	
Half Pitch 2	
Summary	132
Value Chart (E, Horizontal)	133
Spill Out - House 1	
Table (E, Perpendicular)	134
Spill Out - House 2	

MIDSTREAM LIGHTING LIMITED
 WESSEX HOUSE
 1 CHESHAM STREET
 LONDON, SW 1X 8ND, UNITED KINGDOM

Operator MIDSTREAM LIGHTING LIMITED
 Telephone +44 (0)207 584 8310
 Fax
 e-Mail info@midstreamlighting.com

Table of contents

Table (E, Perpendicular)	135
Spill Out - House 3	
Table (E, Perpendicular)	136
Spill Out - House 4	
Table (E, Perpendicular)	137
Spill Out - House 5	
Table (E, Perpendicular)	138
Spill Out - House 6	
Table (E, Perpendicular)	139
Spill Out - House 7	
Table (E, Perpendicular)	140
Spill Out - House 8	
Table (E, Perpendicular)	141
Spill Out - House 9	
Table (E, Perpendicular)	142
Spill Out - House 10	
Table (E, Perpendicular)	143
Spill Out - House 11	
Table (E, Perpendicular)	144
Spill Out - House 12	
Table (E, Perpendicular)	145
Spill Out - House 13	
Table (E, Perpendicular)	146
Spill Out - House 14	
Table (E, Perpendicular)	147
Spill Out - House 15	
Table (E, Perpendicular)	148
Spill Out - House 16	
Table (E, Perpendicular)	149
Spill Out - House 17	
Table (E, Perpendicular)	150
Spill Out - House 18	
Table (E, Perpendicular)	151
Spill Out - House 19	
Table (E, Perpendicular)	152
Spill Out - House 20	
Table (E, Perpendicular)	153
Spill Out - House 21	
Table (E, Perpendicular)	154
Spill Out - House 22	
Table (E, Perpendicular)	155
Spill Out - House 23	
Table (E, Perpendicular)	156
Spill Out - House 24	
Table (E, Perpendicular)	157
Spill Out - House 25	
Table (E, Perpendicular)	158
Spill Out - House 26	
Table (E, Perpendicular)	159
Spill Out - House 27	
Table (E, Perpendicular)	160
Spill Out - House 28	
Table (E, Perpendicular)	161
Spill Out - House 29	

MIDSTREAM LIGHTING LIMITED
 WESSEX HOUSE
 1 CHESHAM STREET
 LONDON, SW 1X 8ND, UNITED KINGDOM

Operator MIDSTREAM LIGHTING LIMITED
 Telephone +44 (0)207 584 8310
 Fax
 e-Mail info@midstreamlighting.com

Table of contents

Table (E, Perpendicular)	162
Spill Out - House 30	
Table (E, Perpendicular)	163
Spill Out - House 31	
Table (E, Perpendicular)	164
Spill Out - House 32	
Table (E, Perpendicular)	165
Spill Out - House 33	
Table (E, Perpendicular)	166
Spill Out - House 34	
Table (E, Perpendicular)	167
Spill Out - House 35	
Table (E, Perpendicular)	168
Spill Out - House 36	
Table (E, Perpendicular)	169
Spill Out - House 37	
Table (E, Perpendicular)	170
Spill Out - House 38	
Table (E, Perpendicular)	171
Spill Out - House 39	
Table (E, Perpendicular)	172
Spill Out - House 40	
Table (E, Perpendicular)	173
Spill Out - House 41	
Table (E, Perpendicular)	174
Spill Out - House 42	
Table (E, Perpendicular)	175
Spill Out - House 43	
Table (E, Perpendicular)	176
Dimming Full Pitch - 350 lux	
Luminaire parts list	177
Sport Luminaires (Coordinates List)	178
Light scenes	
Light scene 1	
Planning data	180
GR Observer (Results Overview)	181
3D Rendering	184
False Color Rendering	185
Exterior Surfaces	
Hockey Pitch Calculation Grid	
Summary	186
Isolines (E, Horizontal)	187
Value Chart (E, Horizontal)	188
Half Pitch 1	
Summary	189
Value Chart (E, Horizontal)	190
Half Pitch 2	
Summary	191
Value Chart (E, Horizontal)	192
Spill Out - House 1	
Table (E, Perpendicular)	193
Spill Out - House 2	
Table (E, Perpendicular)	194
Spill Out - House 3	

MIDSTREAM LIGHTING LIMITED
 WESSEX HOUSE
 1 CHESHAM STREET
 LONDON, SW 1X 8ND, UNITED KINGDOM

Operator MIDSTREAM LIGHTING LIMITED
 Telephone +44 (0)207 584 8310
 Fax
 e-Mail info@midstreamlighting.com

Table of contents

Table (E, Perpendicular)	195
Spill Out - House 4	
Table (E, Perpendicular)	196
Spill Out - House 5	
Table (E, Perpendicular)	197
Spill Out - House 6	
Table (E, Perpendicular)	198
Spill Out - House 7	
Table (E, Perpendicular)	199
Spill Out - House 8	
Table (E, Perpendicular)	200
Spill Out - House 9	
Table (E, Perpendicular)	201
Spill Out - House 10	
Table (E, Perpendicular)	202
Spill Out - House 11	
Table (E, Perpendicular)	203
Spill Out - House 12	
Table (E, Perpendicular)	204
Spill Out - House 13	
Table (E, Perpendicular)	205
Spill Out - House 14	
Table (E, Perpendicular)	206
Spill Out - House 15	
Table (E, Perpendicular)	207
Spill Out - House 16	
Table (E, Perpendicular)	208
Spill Out - House 17	
Table (E, Perpendicular)	209
Spill Out - House 18	
Table (E, Perpendicular)	210
Spill Out - House 19	
Table (E, Perpendicular)	211
Spill Out - House 20	
Table (E, Perpendicular)	212
Spill Out - House 21	
Table (E, Perpendicular)	213
Spill Out - House 22	
Table (E, Perpendicular)	214
Spill Out - House 23	
Table (E, Perpendicular)	215
Spill Out - House 24	
Table (E, Perpendicular)	216
Spill Out - House 25	
Table (E, Perpendicular)	217
Spill Out - House 26	
Table (E, Perpendicular)	218
Spill Out - House 27	
Table (E, Perpendicular)	219
Spill Out - House 28	
Table (E, Perpendicular)	220
Spill Out - House 29	
Table (E, Perpendicular)	221
Spill Out - House 30	

MIDSTREAM LIGHTING LIMITED
WESSEX HOUSE
1 CHESHAM STREET
LONDON, SW 1X 8ND, UNITED KINGDOM

Operator MIDSTREAM LIGHTING LIMITED
Telephone +44 (0)207 584 8310
Fax
e-Mail info@midstreamlighting.com

Table of contents

Table (E, Perpendicular)	222
Spill Out - House 31	
Table (E, Perpendicular)	223
Spill Out - House 32	
Table (E, Perpendicular)	224
Spill Out - House 33	
Table (E, Perpendicular)	225
Spill Out - House 34	
Table (E, Perpendicular)	226
Spill Out - House 35	
Table (E, Perpendicular)	227
Spill Out - House 36	
Table (E, Perpendicular)	228
Spill Out - House 37	
Table (E, Perpendicular)	229
Spill Out - House 38	
Table (E, Perpendicular)	230
Spill Out - House 39	
Table (E, Perpendicular)	231
Spill Out - House 40	
Table (E, Perpendicular)	232
Spill Out - House 41	
Table (E, Perpendicular)	233
Spill Out - House 42	
Table (E, Perpendicular)	234
Spill Out - House 43	
Table (E, Perpendicular)	235

MIDSTREAM LIGHTING LIMITED
WESSEX HOUSE
1 CHESHAM STREET
LONDON, SW 1X 8ND, UNITED KINGDOM

Operator MIDSTREAM LIGHTING LIMITED
Telephone +44 (0)207 584 8310
Fax
e-Mail info@midstreamlighting.com

MIDSTREAM - Modus S1500 WS (5000K) / Luminaire Data Sheet

Luminous emittance 1:

See our luminaire catalog for an image of the luminaire.

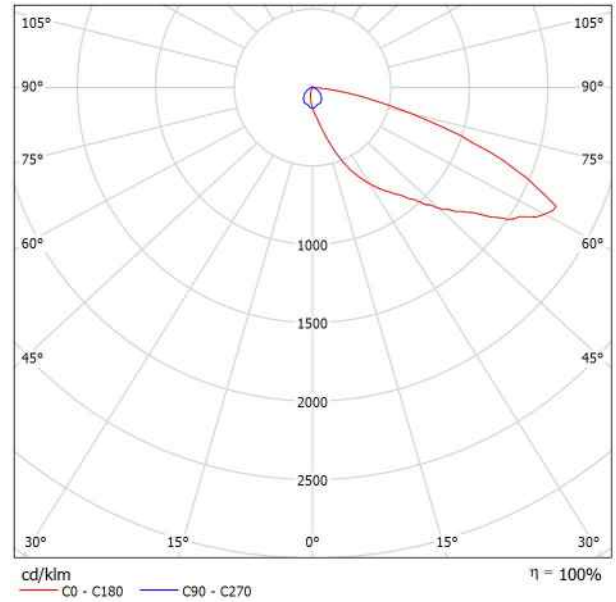

Luminaire classification according to CIE: 100
CIE flux code: 31 67 95 100 100

Due to missing symmetry properties, no UGR table can be displayed for this luminaire.

MIDSTREAM LIGHTING LIMITED
WESSEX HOUSE
1 CHESHAM STREET
LONDON, SW 1X 8ND, UNITED KINGDOM

Operator MIDSTREAM LIGHTING LIMITED
Telephone +44 (0)207 584 8310
Fax
e-Mail info@midstreamlighting.com

MIDSTREAM - Modus S1500 NS (5000K) / Luminaire Data Sheet

Luminous emittance 1:

See our luminaire catalog for an image of the luminaire.

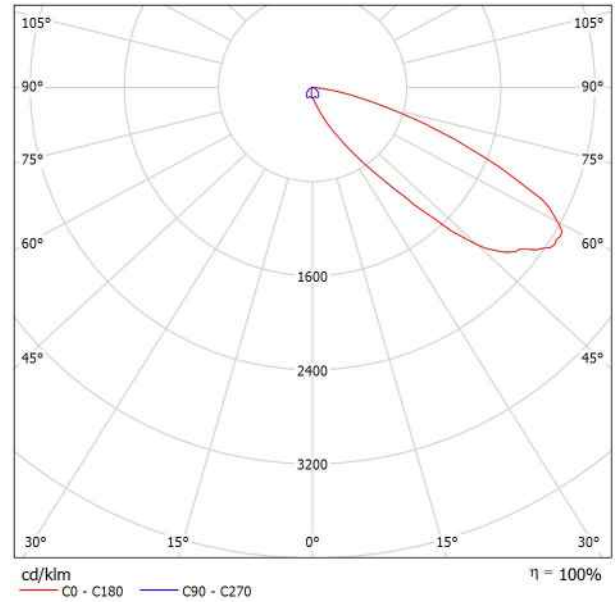

Luminaire classification according to CIE: 100
CIE flux code: 24 67 95 100 100

Due to missing symmetry properties, no UGR table can be displayed for this luminaire.

MIDSTREAM LIGHTING LIMITED
 WESSEX HOUSE
 1 CHESHAM STREET
 LONDON, SW 1X 8ND, UNITED KINGDOM

Operator MIDSTREAM LIGHTING LIMITED
 Telephone +44 (0)207 584 8310
 Fax
 e-Mail info@midstreamlighting.com

Full Pitch / Planning data

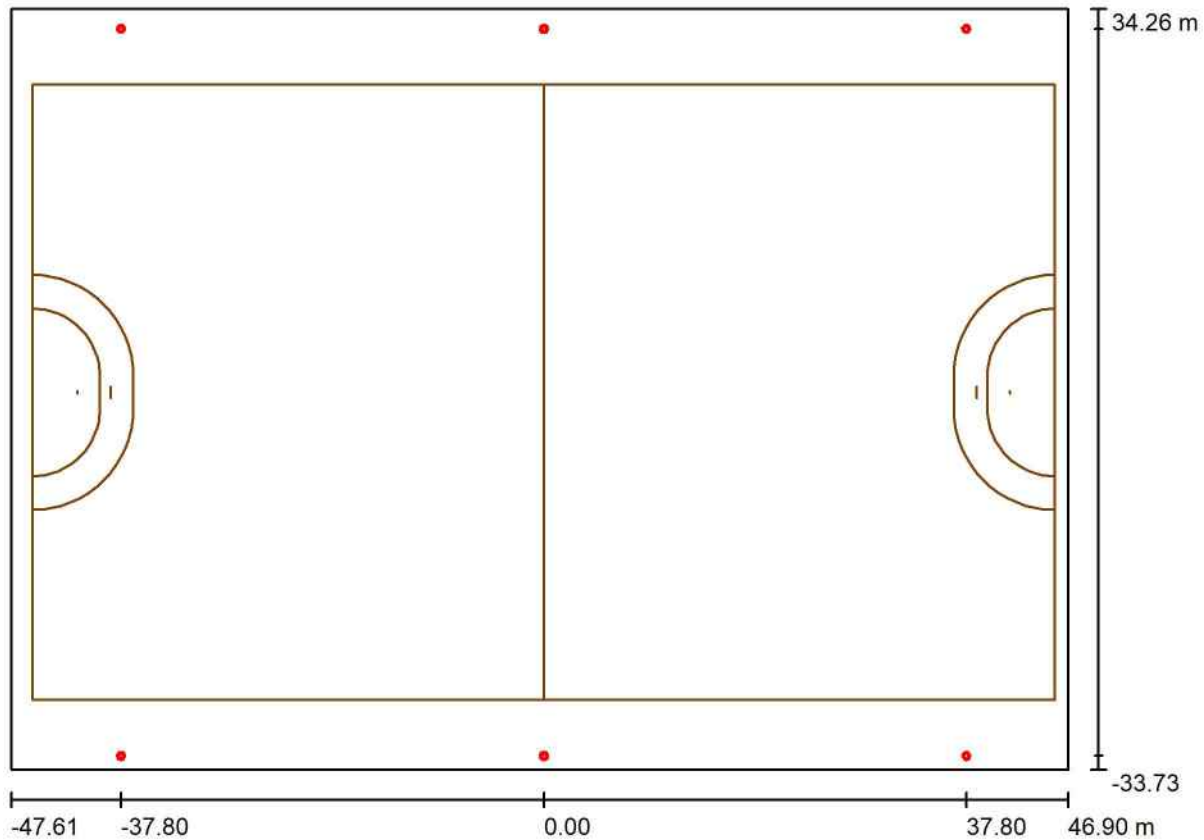

Light loss factor: 0.90, ULR (Upward Light Ratio): 0.5%

Scale 1:676

Luminaire Parts List

No.	Pieces	Designation (Correction Factor)	Φ (Luminaire) [lm]	Φ (Lamps) [lm]	P [W]
1	20	MIDSTREAM - Modus S1500 NS (5000K) (1.000)	172248	172245	1500.0
2	4	MIDSTREAM - Modus S1500 WS (5000K) (1.000)	172247	172246	1500.0
Total:			4133946	Total: 4133884	36000.0

MIDSTREAM LIGHTING LIMITED
WESSEX HOUSE
1 CHESHAM STREET
LONDON, SW 1X 8ND, UNITED KINGDOM

Operator MIDSTREAM LIGHTING LIMITED
Telephone +44 (0)207 584 8310
Fax
e-Mail info@midstreamlighting.com

Full Pitch / Luminaire parts list

20 Pieces MIDSTREAM - Modus S1500 NS (5000K)
Article No.:
Luminous flux (Luminaire): 172248 lm
Luminous flux (Lamps): 172245 lm
Luminaire Wattage: 1500.0 W
Luminaire classification according to CIE: 100
CIE flux code: 24 67 95 100 100
Fitting: 1 x LED (Correction Factor 1.000).

See our luminaire catalog
for an image of the
luminaire.

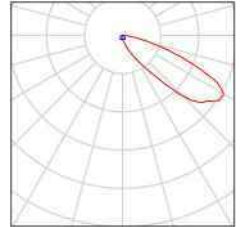

4 Pieces MIDSTREAM - Modus S1500 WS (5000K)
Article No.:
Luminous flux (Luminaire): 172247 lm
Luminous flux (Lamps): 172246 lm
Luminaire Wattage: 1500.0 W
Luminaire classification according to CIE: 100
CIE flux code: 31 67 95 100 100
Fitting: 1 x LED (Correction Factor 1.000).

See our luminaire catalog
for an image of the
luminaire.

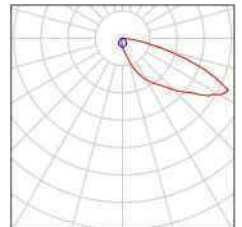

MIDSTREAM LIGHTING LIMITED
 WESSEX HOUSE
 1 CHESHAM STREET
 LONDON, SW 1X 8ND, UNITED KINGDOM

Operator MIDSTREAM LIGHTING LIMITED
 Telephone +44 (0)207 584 8310
 Fax
 e-Mail info@midstreamlighting.com

Full Pitch / Luminaires (layout plan)

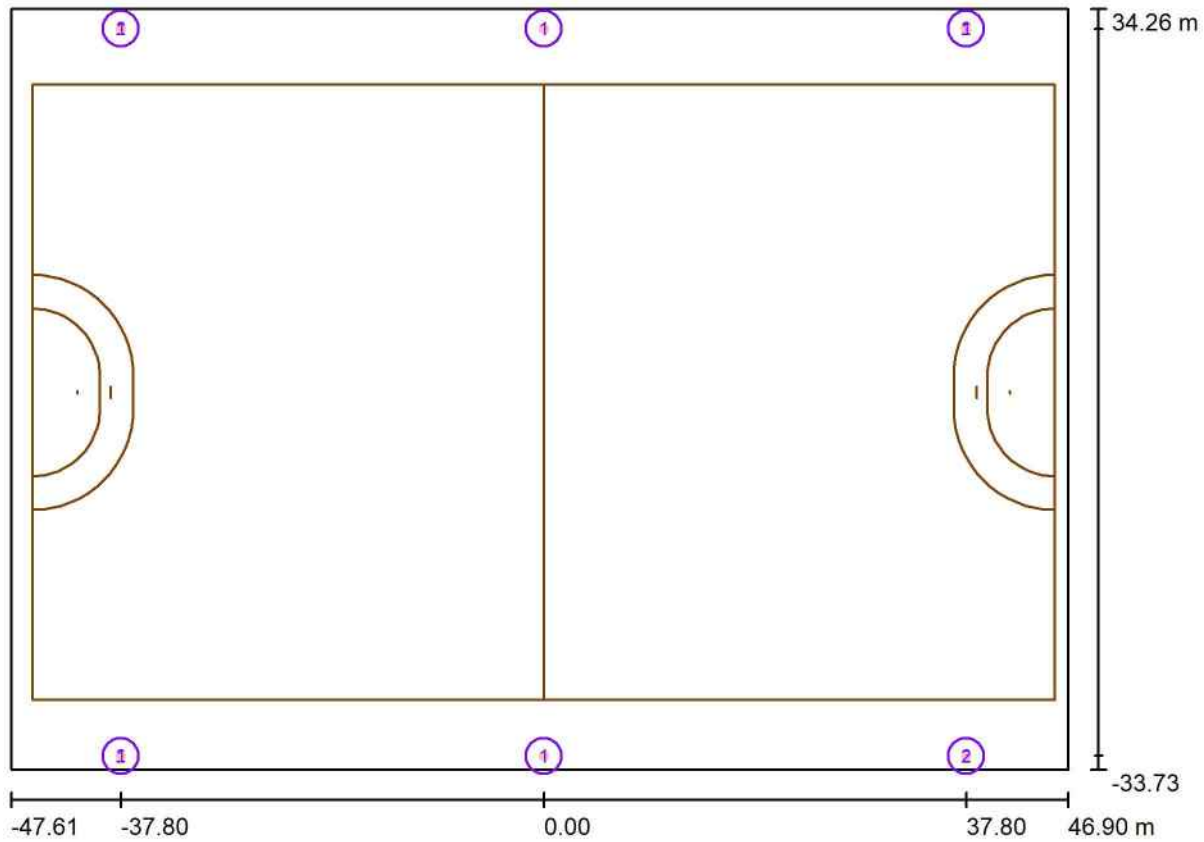

Scale 1 : 676

Luminaire Parts List

No.	Pieces	Designation
1	20	MIDSTREAM - Modus S1500 NS (5000K)
2	4	MIDSTREAM - Modus S1500 WS (5000K)

MIDSTREAM LIGHTING LIMITED
 WESSEX HOUSE
 1 CHESHAM STREET
 LONDON, SW 1X 8ND, UNITED KINGDOM

Operator MIDSTREAM LIGHTING LIMITED
 Telephone +44 (0)207 584 8310
 Fax
 e-Mail info@midstreamlighting.com

Full Pitch / Luminaires (coordinates list)

MIDSTREAM - Modus S1500 NS (5000K)

172248 lm, 1500.0 W, 1 x 1 x LED (Correction Factor 1.000).

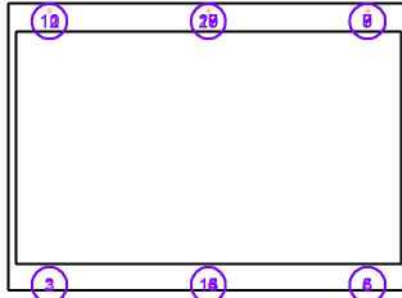

No.	Position [m]			Rotation [°]		
	X	Y	Z	X	Y	Z
1	-37.800	-32.500	15.000	0.0	-5.6	93.3
2	-37.800	-32.500	15.000	0.0	-7.8	63.8
3	-37.800	-32.500	15.000	0.0	-6.5	23.5
4	37.800	-32.500	16.000	0.0	-4.2	87.2
5	37.800	-32.500	16.000	0.0	-6.5	116.8
6	37.800	-32.500	16.000	0.0	-5.1	156.5
7	37.800	32.500	16.000	0.0	-4.2	-87.2
8	37.800	32.500	16.000	0.0	-6.5	-116.8
9	37.800	32.500	16.000	0.0	-5.1	-156.5
10	-37.800	32.500	16.000	0.0	-4.2	-92.8
11	-37.800	32.500	16.000	0.0	-6.5	-63.2
12	-37.800	32.500	16.000	0.0	-5.1	-23.5
13	0.000	-32.500	16.000	0.0	-5.6	125.0
14	0.000	-32.500	16.000	0.0	-5.4	100.4
15	0.000	-32.500	16.000	0.0	-5.6	55.0
16	0.000	-32.500	16.000	0.0	-5.4	79.6
17	0.000	32.500	16.000	0.0	-5.6	-125.0
18	0.000	32.500	16.000	0.0	-5.4	-100.4
19	0.000	32.500	16.000	0.0	-5.6	-55.0
20	0.000	32.500	16.000	0.0	-5.4	-79.6

MIDSTREAM LIGHTING LIMITED
 WESSEX HOUSE
 1 CHESHAM STREET
 LONDON, SW 1X 8ND, UNITED KINGDOM

Operator MIDSTREAM LIGHTING LIMITED
 Telephone +44 (0)207 584 8310
 Fax
 e-Mail info@midstreamlighting.com

Full Pitch / Luminaires (coordinates list)

MIDSTREAM - Modus S1500 WS (5000K)
 172247 lm, 1500.0 W, 1 x 1 x LED (Correction Factor 1.000).

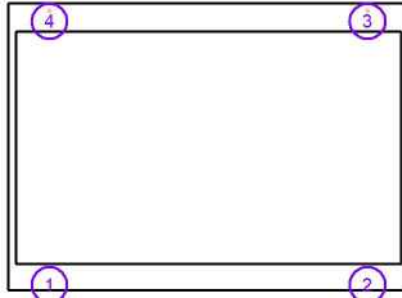

No.	Position [m]			Rotation [°]		
	X	Y	Z	X	Y	Z
1	-37.800	-32.500	15.000	0.0	0.1	98.3
2	37.800	-32.500	16.000	0.0	1.5	81.7
3	37.800	32.500	16.000	0.0	1.5	-81.7
4	-37.800	32.500	16.000	0.0	1.5	-98.3

MIDSTREAM LIGHTING LIMITED
 WESSEX HOUSE
 1 CHESHAM STREET
 LONDON, SW 1X 8ND, UNITED KINGDOM

Operator MIDSTREAM LIGHTING LIMITED
 Telephone +44 (0)207 584 8310
 Fax
 e-Mail info@midstreamlighting.com

Full Pitch / GR Observer (Results Overview)

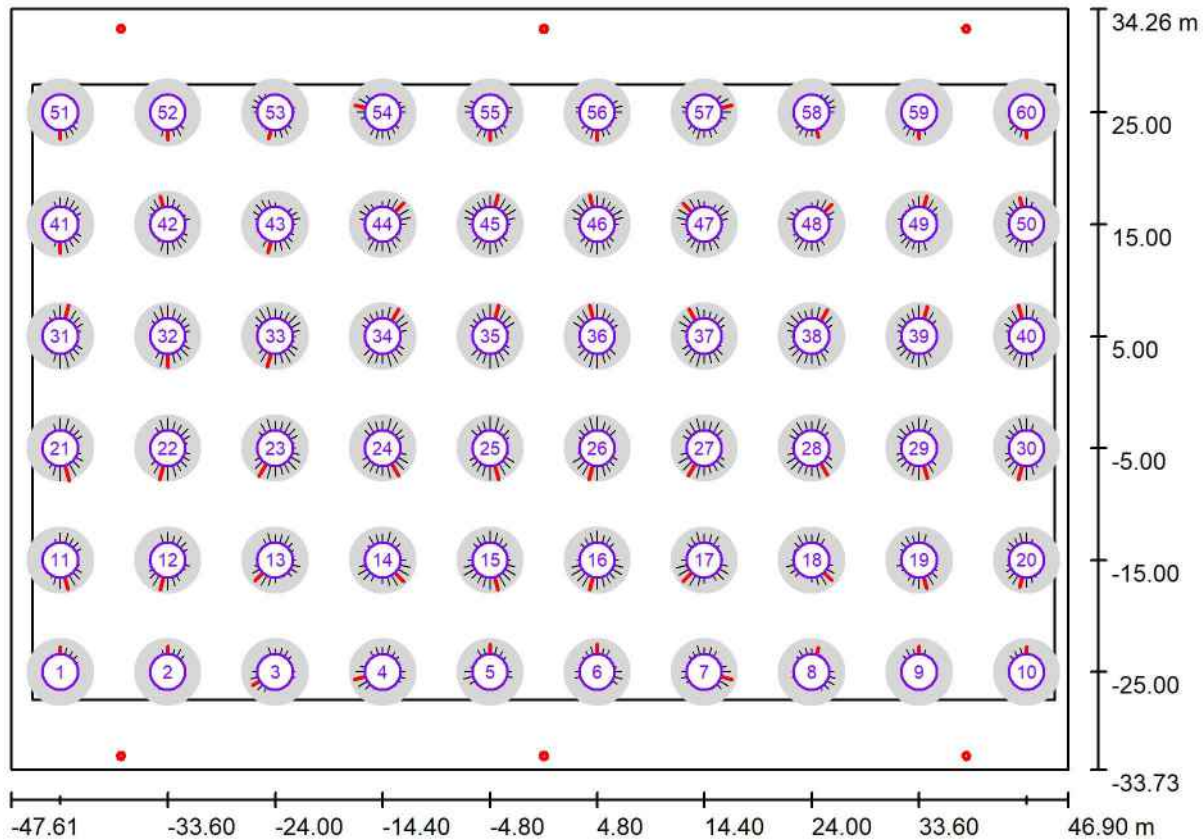

Scale 1 : 676

GR Observerlist

No.	Designation	Position [m]			Viewing sector [°]			Slope angle	Max
		X	Y	Z	Start	End	Increment		
1	GR Observer 1	-43.200	-25.000	1.500	0.0	360.0	15.0	-2.0	34 ²⁾
2	GR Observer 2	-33.600	-25.000	1.500	0.0	360.0	15.0	-2.0	35 ²⁾
3	GR Observer 3	-24.000	-25.000	1.500	0.0	360.0	15.0	-2.0	36 ²⁾
4	GR Observer 4	-14.400	-25.000	1.500	0.0	360.0	15.0	-2.0	40 ²⁾

MIDSTREAM LIGHTING LIMITED
 WESSEX HOUSE
 1 CHESHAM STREET
 LONDON, SW 1X 8ND, UNITED KINGDOM

Operator MIDSTREAM LIGHTING LIMITED
 Telephone +44 (0)207 584 8310
 Fax
 e-Mail info@midstreamlighting.com

Full Pitch / GR Observer (Results Overview)

GR Observerlist

No.	Designation	Position [m]			Start	Viewing sector [°]			Max
		X	Y	Z		End	Increment	Slope angle	
5	GR Observer 5	-4.800	-25.000	1.500	0.0	360.0	15.0	-2.0	37 ²⁾
6	GR Observer 6	4.800	-25.000	1.500	0.0	360.0	15.0	-2.0	37 ²⁾
7	GR Observer 7	14.400	-25.000	1.500	0.0	360.0	15.0	-2.0	38 ²⁾
8	GR Observer 8	24.000	-25.000	1.500	0.0	360.0	15.0	-2.0	34 ²⁾
9	GR Observer 9	33.600	-25.000	1.500	0.0	360.0	15.0	-2.0	35 ²⁾
10	GR Observer 10	43.200	-25.000	1.500	0.0	360.0	15.0	-2.0	34 ²⁾
11	GR Observer 11	-43.200	-15.000	1.500	0.0	360.0	15.0	-2.0	40 ²⁾
12	GR Observer 12	-33.600	-15.000	1.500	0.0	360.0	15.0	-2.0	41 ²⁾
13	GR Observer 13	-24.000	-15.000	1.500	0.0	360.0	15.0	-2.0	39 ²⁾
14	GR Observer 14	-14.400	-15.000	1.500	0.0	360.0	15.0	-2.0	40 ²⁾
15	GR Observer 15	-4.800	-15.000	1.500	0.0	360.0	15.0	-2.0	41 ²⁾
16	GR Observer 16	4.800	-15.000	1.500	0.0	360.0	15.0	-2.0	41 ²⁾
17	GR Observer 17	14.400	-15.000	1.500	0.0	360.0	15.0	-2.0	40 ²⁾
18	GR Observer 18	24.000	-15.000	1.500	0.0	360.0	15.0	-2.0	38 ²⁾
19	GR Observer 19	33.600	-15.000	1.500	0.0	360.0	15.0	-2.0	39 ²⁾
20	GR Observer 20	43.200	-15.000	1.500	0.0	360.0	15.0	-2.0	38 ²⁾
21	GR Observer 21	-43.200	-5.000	1.500	0.0	360.0	15.0	-2.0	45 ²⁾
22	GR Observer 22	-33.600	-5.000	1.500	0.0	360.0	15.0	-2.0	43 ²⁾
23	GR Observer 23	-24.000	-5.000	1.500	0.0	360.0	15.0	-2.0	43 ²⁾
24	GR Observer 24	-14.400	-5.000	1.500	0.0	360.0	15.0	-2.0	43 ²⁾
25	GR Observer 25	-4.800	-5.000	1.500	0.0	360.0	15.0	-2.0	44 ²⁾
26	GR Observer 26	4.800	-5.000	1.500	0.0	360.0	15.0	-2.0	44 ²⁾
27	GR Observer 27	14.400	-5.000	1.500	0.0	360.0	15.0	-2.0	43 ²⁾
28	GR Observer 28	24.000	-5.000	1.500	0.0	360.0	15.0	-2.0	42 ²⁾
29	GR Observer 29	33.600	-5.000	1.500	0.0	360.0	15.0	-2.0	42 ²⁾
30	GR Observer 30	43.200	-5.000	1.500	0.0	360.0	15.0	-2.0	43 ²⁾
31	GR Observer 31	-43.200	5.000	1.500	0.0	360.0	15.0	-2.0	43 ²⁾
32	GR Observer 32	-33.600	5.000	1.500	0.0	360.0	15.0	-2.0	42 ²⁾
33	GR Observer 33	-24.000	5.000	1.500	0.0	360.0	15.0	-2.0	42 ²⁾
34	GR Observer 34	-14.400	5.000	1.500	0.0	360.0	15.0	-2.0	43 ²⁾
35	GR Observer 35	-4.800	5.000	1.500	0.0	360.0	15.0	-2.0	44 ²⁾
36	GR Observer 36	4.800	5.000	1.500	0.0	360.0	15.0	-2.0	44 ²⁾
37	GR Observer 37	14.400	5.000	1.500	0.0	360.0	15.0	-2.0	43 ²⁾
38	GR Observer 38	24.000	5.000	1.500	0.0	360.0	15.0	-2.0	42 ²⁾
39	GR Observer 39	33.600	5.000	1.500	0.0	360.0	15.0	-2.0	42 ²⁾
40	GR Observer 40	43.200	5.000	1.500	0.0	360.0	15.0	-2.0	43 ²⁾

MIDSTREAM LIGHTING LIMITED
 WESSEX HOUSE
 1 CHESHAM STREET
 LONDON, SW 1X 8ND, UNITED KINGDOM

Operator MIDSTREAM LIGHTING LIMITED
 Telephone +44 (0)207 584 8310
 Fax
 e-Mail info@midstreamlighting.com

Full Pitch / GR Observer (Results Overview)

GR Observerlist

No.	Designation	Position [m]			Viewing sector [°]			Slope angle	Max
		X	Y	Z	Start	End	Increment		
41	GR Observer 41	-43.200	15.000	1.500	0.0	360.0	15.0	-2.0	39 ²⁾
42	GR Observer 42	-33.600	15.000	1.500	0.0	360.0	15.0	-2.0	39 ²⁾
43	GR Observer 43	-24.000	15.000	1.500	0.0	360.0	15.0	-2.0	39 ²⁾
44	GR Observer 44	-14.400	15.000	1.500	0.0	360.0	15.0	-2.0	40 ²⁾
45	GR Observer 45	-4.800	15.000	1.500	0.0	360.0	15.0	-2.0	41 ²⁾
46	GR Observer 46	4.800	15.000	1.500	0.0	360.0	15.0	-2.0	41 ²⁾
47	GR Observer 47	14.400	15.000	1.500	0.0	360.0	15.0	-2.0	40 ²⁾
48	GR Observer 48	24.000	15.000	1.500	0.0	360.0	15.0	-2.0	38 ²⁾
49	GR Observer 49	33.600	15.000	1.500	0.0	360.0	15.0	-2.0	39 ²⁾
50	GR Observer 50	43.200	15.000	1.500	0.0	360.0	15.0	-2.0	38 ²⁾
51	GR Observer 51	-43.200	25.000	1.500	0.0	360.0	15.0	-2.0	36 ²⁾
52	GR Observer 52	-33.600	25.000	1.500	0.0	360.0	15.0	-2.0	37 ²⁾
53	GR Observer 53	-24.000	25.000	1.500	0.0	360.0	15.0	-2.0	36 ²⁾
54	GR Observer 54	-14.400	25.000	1.500	0.0	360.0	15.0	-2.0	38 ²⁾
55	GR Observer 55	-4.800	25.000	1.500	0.0	360.0	15.0	-2.0	37 ²⁾
56	GR Observer 56	4.800	25.000	1.500	0.0	360.0	15.0	-2.0	37 ²⁾
57	GR Observer 57	14.400	25.000	1.500	0.0	360.0	15.0	-2.0	38 ²⁾
58	GR Observer 58	24.000	25.000	1.500	0.0	360.0	15.0	-2.0	34 ²⁾
59	GR Observer 59	33.600	25.000	1.500	0.0	360.0	15.0	-2.0	35 ²⁾
60	GR Observer 60	43.200	25.000	1.500	0.0	360.0	15.0	-2.0	34 ²⁾

2) The calculated equivalent veil luminance of the environment is based on the assumption of a complete diffuse reflection behavior of the environment (acc. EN 12464-2).

MIDSTREAM LIGHTING LIMITED
WESSEX HOUSE
1 CHESHAM STREET
LONDON, SW 1X 8ND, UNITED KINGDOM

Operator MIDSTREAM LIGHTING LIMITED
Telephone +44 (0)207 584 8310
Fax
e-Mail info@midstreamlighting.com

Full Pitch / 3D Rendering

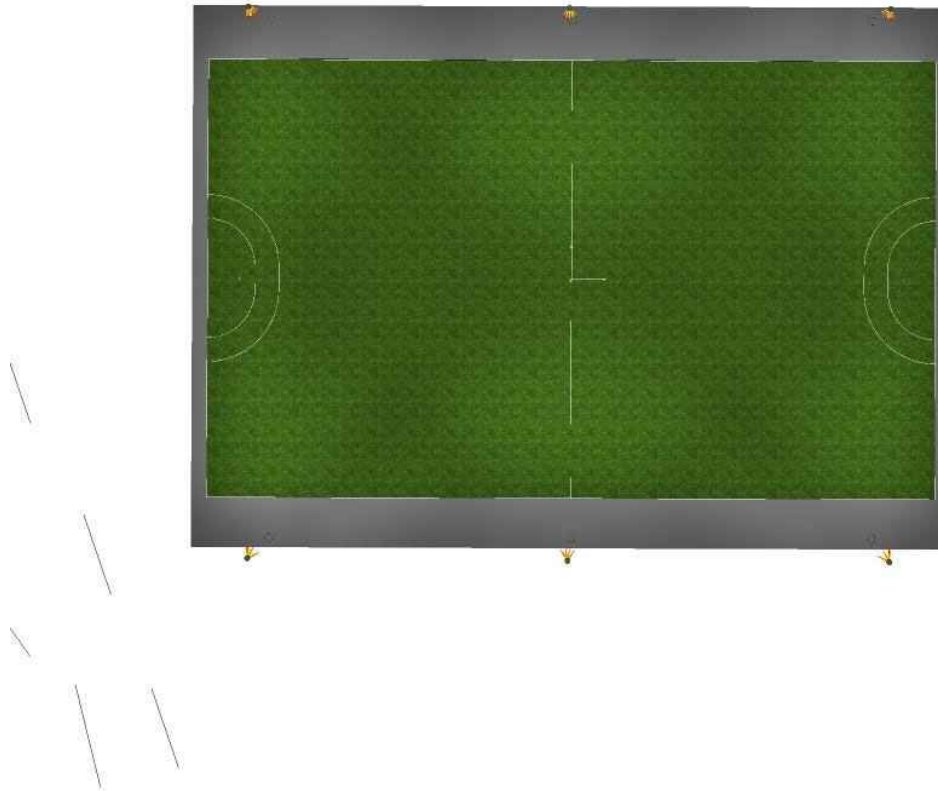

MIDSTREAM LIGHTING LIMITED
WESSEX HOUSE
1 CHESHAM STREET
LONDON, SW 1X 8ND, UNITED KINGDOM

Operator MIDSTREAM LIGHTING LIMITED
Telephone +44 (0)207 584 8310
Fax
e-Mail info@midstreamlighting.com

Full Pitch / False Color Rendering

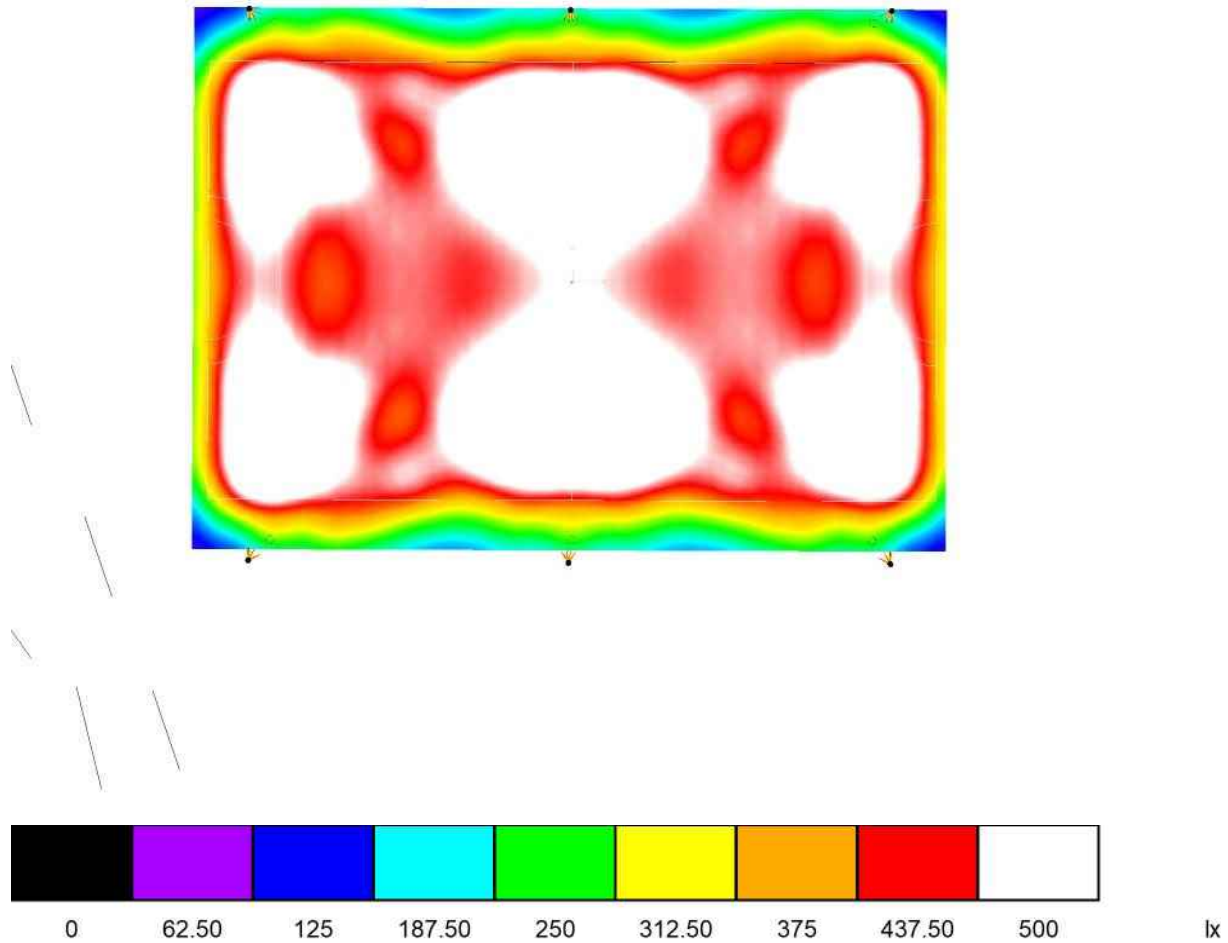

MIDSTREAM LIGHTING LIMITED
 WESSEX HOUSE
 1 CHESHAM STREET
 LONDON, SW 1X 8ND, UNITED KINGDOM

Operator MIDSTREAM LIGHTING LIMITED
 Telephone +44 (0)207 584 8310
 Fax
 e-Mail info@midstreamlighting.com

Full Pitch / Hockey Pitch Calculation Grid / Summary

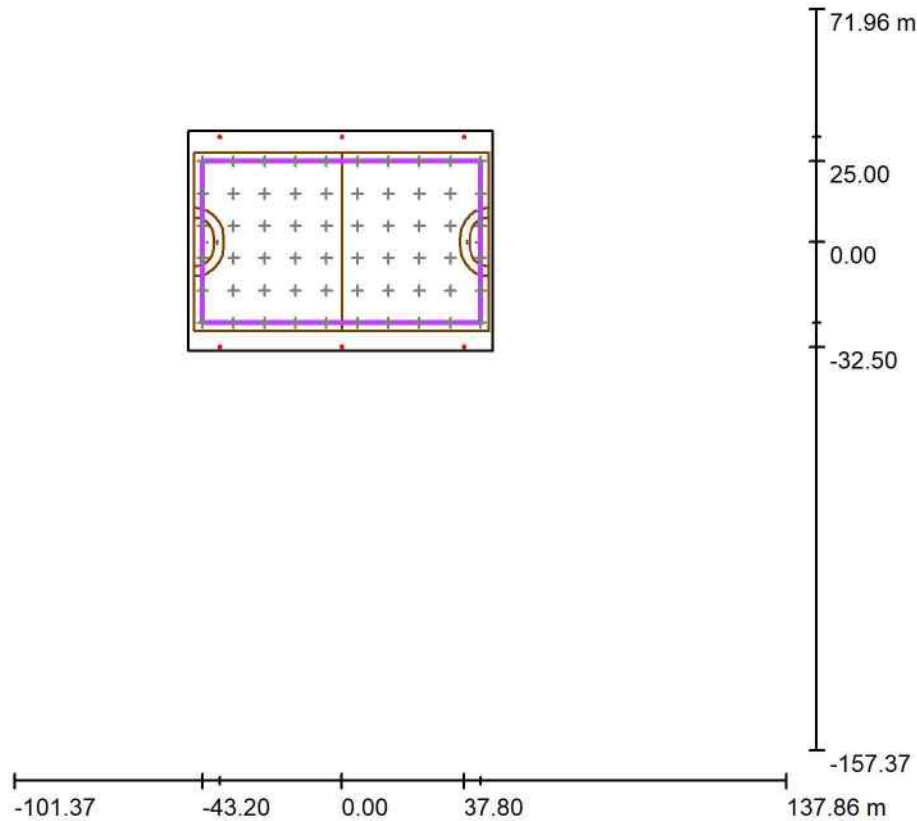

Scale 1 : 2343

Position: (0.000 m, 0.000 m, 0.000 m)
 Size: (86.400 m, 50.000 m)
 Rotation: (0.0°, 0.0°, 0.0°)
 Type: Normal, Grid: 10 x 6 Points
 Belongs to the following sport arena: Hockey Pitch

Results overview

No.	Type	E_{av} [lx]	E_{min} [lx]	E_{max} [lx]	u0	E_{min} / E_{max}	$E_{h\ m} / E_m$	H [m]	Camera
1	horizontal	518	444	759	0.86	0.58	/	0.000	/

$E_{h\ m} / E_m$ = Relationship between middle horizontal and vertical illuminance, H = Measuring Height

MIDSTREAM LIGHTING LIMITED
 WESSEX HOUSE
 1 CHESHAM STREET
 LONDON, SW 1X 8ND, UNITED KINGDOM

Operator MIDSTREAM LIGHTING LIMITED
 Telephone +44 (0)207 584 8310
 Fax
 e-Mail info@midstreamlighting.com

Full Pitch / Hockey Pitch Calculation Grid / Isolines (E, Horizontal)

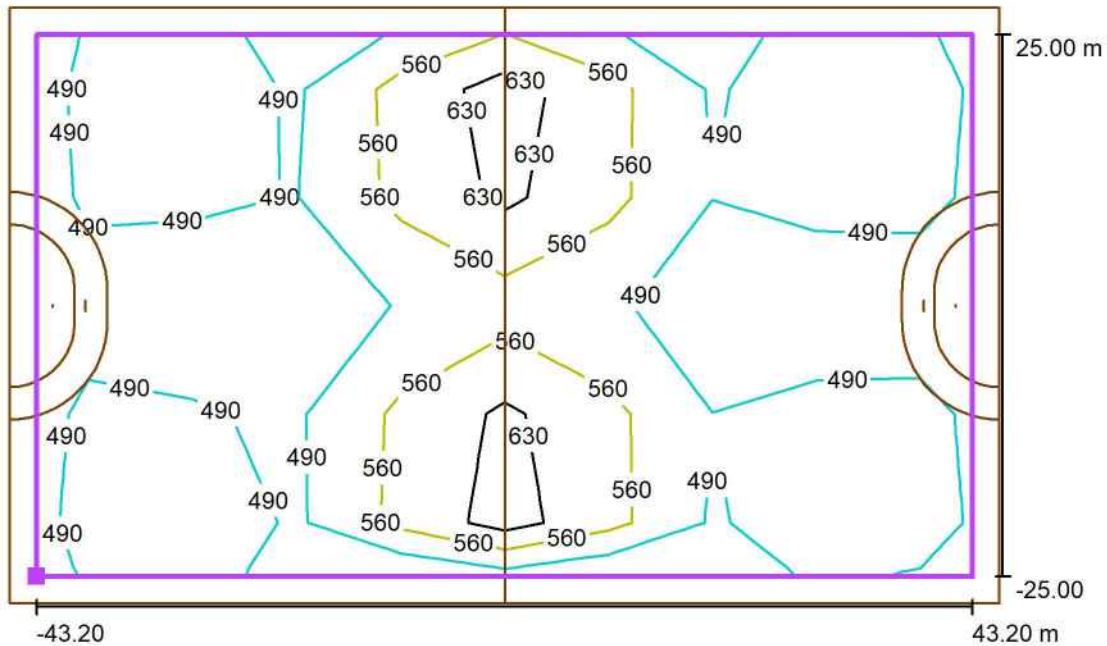

Values in Lux, Scale 1 : 698

Position of surface in external scene:
 Marked point: (-43.200 m, -25.000 m,
 0.000 m)



Grid: 10 x 6 Points

E_{av} [lx]	E_{min} [lx]	E_{max} [lx]	$u0$	E_{min} / E_{max}
518	444	759	0.86	0.58

MIDSTREAM LIGHTING LIMITED
 WESSEX HOUSE
 1 CHESHAM STREET
 LONDON, SW 1X 8ND, UNITED KINGDOM

Operator MIDSTREAM LIGHTING LIMITED
 Telephone +44 (0)207 584 8310
 Fax
 e-Mail info@midstreamlighting.com

Full Pitch / Hockey Pitch Calculation Grid / Greyscale (E, Horizontal)

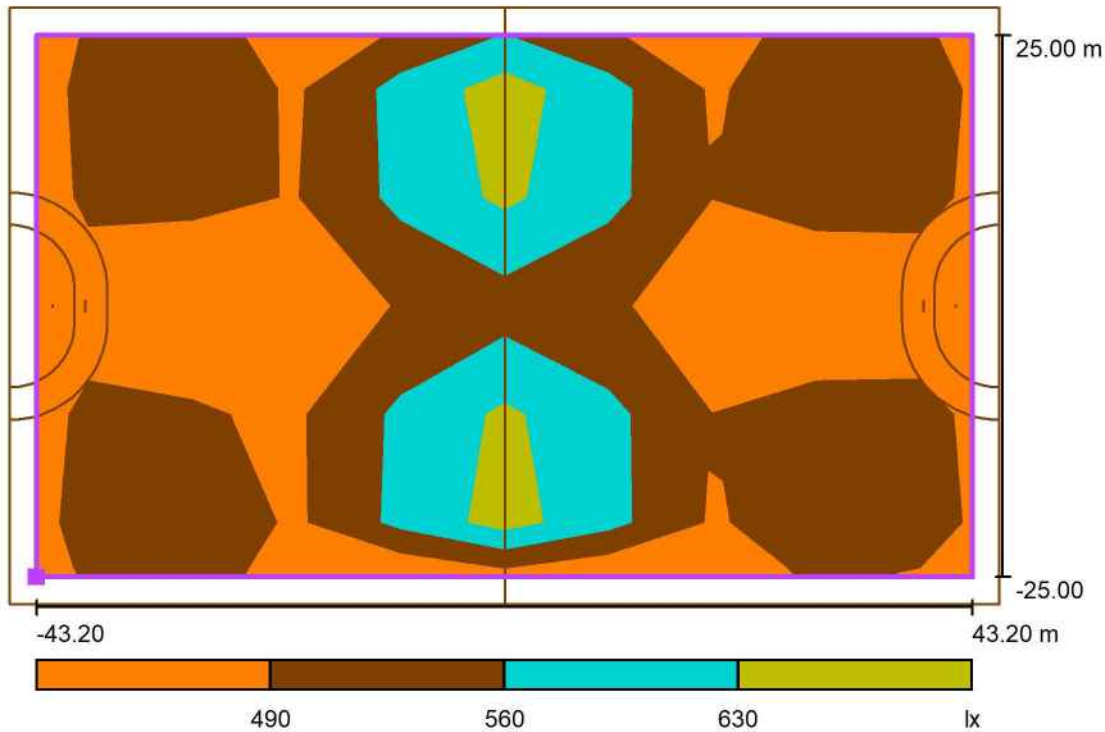

Scale 1 : 698

Position of surface in external scene:
 Marked point: (-43.200 m, -25.000 m,
 0.000 m)



Grid: 10 x 6 Points

E_{av} [lx]	E_{min} [lx]	E_{max} [lx]	u0	E_{min} / E_{max}
518	444	759	0.86	0.58

MIDSTREAM LIGHTING LIMITED
 WESSEX HOUSE
 1 CHESHAM STREET
 LONDON, SW 1X 8ND, UNITED KINGDOM

Operator MIDSTREAM LIGHTING LIMITED
 Telephone +44 (0)207 584 8310
 Fax
 e-Mail info@midstreamlighting.com

Full Pitch / Hockey Pitch Calculation Grid / Value Chart (E, Horizontal)

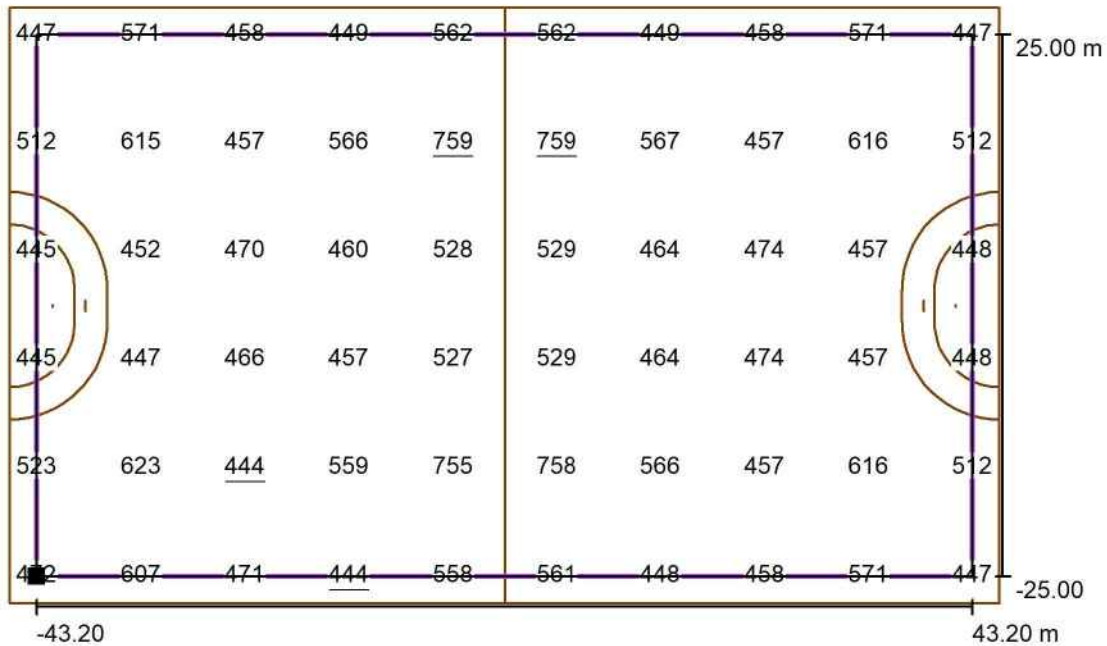

Values in Lux, Scale 1 : 698

Position of surface in external scene:
 Marked point: (-43.200 m, -25.000 m,
 0.000 m)



Grid: 10 x 6 Points

E_{av} [lx]	E_{min} [lx]	E_{max} [lx]	u0	E_{min} / E_{max}
518	444	759	0.86	0.58

MIDSTREAM LIGHTING LIMITED
 WESSEX HOUSE
 1 CHESHAM STREET
 LONDON, SW 1X 8ND, UNITED KINGDOM

Operator MIDSTREAM LIGHTING LIMITED
 Telephone +44 (0)207 584 8310
 Fax
 e-Mail info@midstreamlighting.com

Full Pitch / Spill Out - House 1 / Table (E, Perpendicular)



Position of surface in external scene:
 Marked point: (105.514 m, 71.961 m,
 0.000 m)

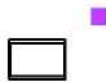

1.000 4.84

0.000 5.02

m **5.000**

Attention: The coordinates refer to the image above. Values in Lux.

Grid: 1 x 2 Points

E_{av} [lx]	E_{min} [lx]	E_{max} [lx]	$u0$	E_{min} / E_{max}
4.93	4.84	5.02	0.98	0.96

MIDSTREAM LIGHTING LIMITED
 WESSEX HOUSE
 1 CHESHAM STREET
 LONDON, SW 1X 8ND, UNITED KINGDOM

Operator MIDSTREAM LIGHTING LIMITED
 Telephone +44 (0)207 584 8310
 Fax
 e-Mail info@midstreamlighting.com

Full Pitch / Spill Out - House 2 / Table (E, Perpendicular)



Position of surface in external scene:
 Marked point: (109.320 m, 43.252 m,
 0.000 m)

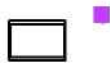

1.000 7.00

0.000 7.27

m 5.000

Attention: The coordinates refer to the image above. Values in Lux.

Grid: 1 x 2 Points

E_{av} [lx]	E_{min} [lx]	E_{max} [lx]	$u0$	E_{min} / E_{max}
7.13	7.00	7.27	0.98	0.96

MIDSTREAM LIGHTING LIMITED
 WESSEX HOUSE
 1 CHESHAM STREET
 LONDON, SW 1X 8ND, UNITED KINGDOM

Operator MIDSTREAM LIGHTING LIMITED
 Telephone +44 (0)207 584 8310
 Fax
 e-Mail info@midstreamlighting.com

Full Pitch / Spill Out - House 3 / Table (E, Perpendicular)



Position of surface in external scene:
 Marked point: (111.607 m, 27.470 m,
 0.000 m)



1.000 7.83

0.000 8.11

m 4.000

Attention: The coordinates refer to the image above. Values in Lux.

Grid: 1 x 2 Points

E_{av} [lx]
7.97

E_{min} [lx]
7.83

E_{max} [lx]
8.11

u0
0.98

E_{min} / E_{max}
0.96

MIDSTREAM LIGHTING LIMITED
 WESSEX HOUSE
 1 CHESHAM STREET
 LONDON, SW 1X 8ND, UNITED KINGDOM

Operator MIDSTREAM LIGHTING LIMITED
 Telephone +44 (0)207 584 8310
 Fax
 e-Mail info@midstreamlighting.com

Full Pitch / Spill Out - House 4 / Table (E, Perpendicular)



Position of surface in external scene:
 Marked point: (112.554 m, 17.411 m,
 0.000 m)

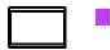

1.000 8.02

0.000 8.31

m 5.000

Attention: The coordinates refer to the image above. Values in Lux.

Grid: 1 x 2 Points

E_{av} [lx]	E_{min} [lx]	E_{max} [lx]	$u0$	E_{min} / E_{max}
8.16	8.02	8.31	0.98	0.97

MIDSTREAM LIGHTING LIMITED
 WESSEX HOUSE
 1 CHESHAM STREET
 LONDON, SW 1X 8ND, UNITED KINGDOM

Operator MIDSTREAM LIGHTING LIMITED
 Telephone +44 (0)207 584 8310
 Fax
 e-Mail info@midstreamlighting.com

Full Pitch / Spill Out - House 5 / Table (E, Perpendicular)



Position of surface in external scene:
 Marked point: (112.921 m, 4.824 m,
 0.000 m)

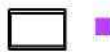

1.000 7.95

0.000 8.27

m 5.000

Attention: The coordinates refer to the image above. Values in Lux.

Grid: 1 x 2 Points

E_{av} [lx]
8.11

E_{min} [lx]
7.95

E_{max} [lx]
8.27

$u0$
0.98

E_{min} / E_{max}
0.96

MIDSTREAM LIGHTING LIMITED
 WESSEX HOUSE
 1 CHESHAM STREET
 LONDON, SW 1X 8ND, UNITED KINGDOM

Operator MIDSTREAM LIGHTING LIMITED
 Telephone +44 (0)207 584 8310
 Fax
 e-Mail info@midstreamlighting.com

Full Pitch / Spill Out - House 6 / Table (E, Perpendicular)



Position of surface in external scene:
 Marked point: (114.805 m, -9.359 m,
 0.000 m)

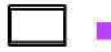

1.000 7.03

0.000 7.32

m 4.000

Attention: The coordinates refer to the image above. Values in Lux.

Grid: 1 x 2 Points

E_{av} [lx]
7.17

E_{min} [lx]
7.03

E_{max} [lx]
7.32

u0
0.98

E_{min} / E_{max}
0.96

MIDSTREAM LIGHTING LIMITED
 WESSEX HOUSE
 1 CHESHAM STREET
 LONDON, SW 1X 8ND, UNITED KINGDOM

Operator MIDSTREAM LIGHTING LIMITED
 Telephone +44 (0)207 584 8310
 Fax
 e-Mail info@midstreamlighting.com

Full Pitch / Spill Out - House 7 / Table (E, Perpendicular)



Position of surface in external scene:
 Marked point: (115.660 m, -20.479 m,
 0.000 m)

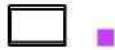

1.000 6.11

0.000 6.36

m **4.000**

Attention: The coordinates refer to the image above. Values in Lux.

Grid: 1 x 2 Points

E_{av} [lx]
6.24

E_{min} [lx]
6.11

E_{max} [lx]
6.36

u0
0.98

E_{min} / E_{max}
0.96

MIDSTREAM LIGHTING LIMITED
 WESSEX HOUSE
 1 CHESHAM STREET
 LONDON, SW 1X 8ND, UNITED KINGDOM

Operator MIDSTREAM LIGHTING LIMITED
 Telephone +44 (0)207 584 8310
 Fax
 e-Mail info@midstreamlighting.com

Full Pitch / Spill Out - House 8 / Table (E, Perpendicular)



Position of surface in external scene:
 Marked point: (116.882 m, -32.699 m,
 0.000 m)



1.000 4.93

0.000 5.15

m **4.000**

Attention: The coordinates refer to the image above. Values in Lux.

Grid: 1 x 2 Points

E_{av} [lx]
5.04

E_{min} [lx]
4.93

E_{max} [lx]
5.15

u0
0.98

E_{min} / E_{max}
0.96

MIDSTREAM LIGHTING LIMITED
 WESSEX HOUSE
 1 CHESHAM STREET
 LONDON, SW 1X 8ND, UNITED KINGDOM

Operator MIDSTREAM LIGHTING LIMITED
 Telephone +44 (0)207 584 8310
 Fax
 e-Mail info@midstreamlighting.com

Full Pitch / Spill Out - House 9 / Table (E, Perpendicular)



Position of surface in external scene:
 Marked point: (120.096 m, -43.937 m,
 0.000 m)

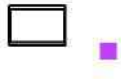

1.000 3.86

0.000 4.02

m 4.500

Attention: The coordinates refer to the image above. Values in Lux.

Grid: 1 x 2 Points

E_{av} [lx]	E_{min} [lx]	E_{max} [lx]	$u0$	E_{min} / E_{max}
3.94	3.86	4.02	0.98	0.96

MIDSTREAM LIGHTING LIMITED
 WESSEX HOUSE
 1 CHESHAM STREET
 LONDON, SW 1X 8ND, UNITED KINGDOM

Operator MIDSTREAM LIGHTING LIMITED
 Telephone +44 (0)207 584 8310
 Fax
 e-Mail info@midstreamlighting.com

Full Pitch / Spill Out - House 10 / Table (E, Perpendicular)



Position of surface in external scene:
 Marked point: (122.381 m, -56.528 m,
 0.000 m)

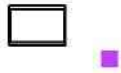

1.000 3.14

0.000 3.25

m **4.000**

Attention: The coordinates refer to the image above. Values in Lux.

Grid: 1 x 2 Points

E_{av} [lx]	E_{min} [lx]	E_{max} [lx]	u0	E_{min} / E_{max}
3.19	3.14	3.25	0.98	0.96

MIDSTREAM LIGHTING LIMITED
 WESSEX HOUSE
 1 CHESHAM STREET
 LONDON, SW 1X 8ND, UNITED KINGDOM

Operator MIDSTREAM LIGHTING LIMITED
 Telephone +44 (0)207 584 8310
 Fax
 e-Mail info@midstreamlighting.com

Full Pitch / Spill Out - House 11 / Table (E, Perpendicular)



Position of surface in external scene:
 Marked point: (124.128 m, -67.767 m,
 0.000 m)

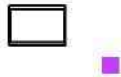

1.000 2.60

0.000 2.70

m 4.500

Attention: The coordinates refer to the image above. Values in Lux.

Grid: 1 x 2 Points

E_{av} [lx]	E_{min} [lx]	E_{max} [lx]	$u0$	E_{min} / E_{max}
2.65	2.60	2.70	0.98	0.96

MIDSTREAM LIGHTING LIMITED
 WESSEX HOUSE
 1 CHESHAM STREET
 LONDON, SW 1X 8ND, UNITED KINGDOM

Operator MIDSTREAM LIGHTING LIMITED
 Telephone +44 (0)207 584 8310
 Fax
 e-Mail info@midstreamlighting.com

Full Pitch / Spill Out - House 12 / Table (E, Perpendicular)



Position of surface in external scene:
 Marked point: (127.356 m, -79.016 m,
 0.000 m)

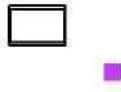

1.000 2.18

0.000 2.27

m 3.500

Attention: The coordinates refer to the image above. Values in Lux.

Grid: 1 x 2 Points

E_{av} [lx]	E_{min} [lx]	E_{max} [lx]	u0	E_{min} / E_{max}
2.23	2.18	2.27	0.98	0.96

MIDSTREAM LIGHTING LIMITED
 WESSEX HOUSE
 1 CHESHAM STREET
 LONDON, SW 1X 8ND, UNITED KINGDOM

Operator MIDSTREAM LIGHTING LIMITED
 Telephone +44 (0)207 584 8310
 Fax
 e-Mail info@midstreamlighting.com

Full Pitch / Spill Out - House 13 / Table (E, Perpendicular)



Position of surface in external scene:
 Marked point: (128.212 m, -88.548 m,
 0.000 m)

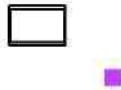

1.000 1.92
0.000 2.00
m **3.500**

Attention: The coordinates refer to the image above. Values in Lux.

Grid: 1 x 2 Points

E_{av} [lx]	E_{min} [lx]	E_{max} [lx]	u0	E_{min} / E_{max}
1.96	1.92	2.00	0.98	0.96

MIDSTREAM LIGHTING LIMITED
 WESSEX HOUSE
 1 CHESHAM STREET
 LONDON, SW 1X 8ND, UNITED KINGDOM

Operator MIDSTREAM LIGHTING LIMITED
 Telephone +44 (0)207 584 8310
 Fax
 e-Mail info@midstreamlighting.com

Full Pitch / Spill Out - House 14 / Table (E, Perpendicular)



Position of surface in external scene:
 Marked point: (129.958 m, -99.421 m,
 0.000 m)



1.000 1.64

0.000 1.71

m 4.000

Attention: The coordinates refer to the image above. Values in Lux.

Grid: 1 x 2 Points

E_{av} [lx]	E_{min} [lx]	E_{max} [lx]	u0	E_{min} / E_{max}
1.67	1.64	1.71	0.98	0.96

MIDSTREAM LIGHTING LIMITED
 WESSEX HOUSE
 1 CHESHAM STREET
 LONDON, SW 1X 8ND, UNITED KINGDOM

Operator MIDSTREAM LIGHTING LIMITED
 Telephone +44 (0)207 584 8310
 Fax
 e-Mail info@midstreamlighting.com

Full Pitch / Spill Out - House 15 / Table (E, Perpendicular)



Position of surface in external scene:
 Marked point: (131.965 m, -
 109.204 m, 0.000 m)



1.000 1.46
0.000 1.51
 m **3.000**

Attention: The coordinates refer to the image above. Values in Lux.

Grid: 1 x 2 Points

E_{av} [lx]	E_{min} [lx]	E_{max} [lx]	$u0$	E_{min} / E_{max}
1.49	1.46	1.51	0.98	0.96

MIDSTREAM LIGHTING LIMITED
 WESSEX HOUSE
 1 CHESHAM STREET
 LONDON, SW 1X 8ND, UNITED KINGDOM

Operator MIDSTREAM LIGHTING LIMITED
 Telephone +44 (0)207 584 8310
 Fax
 e-Mail info@midstreamlighting.com

Full Pitch / Spill Out - House 16 / Table (E, Perpendicular)



Position of surface in external scene:
 Marked point: (133.857 m, -
 122.247 m, 0.000 m)



1.000 1.31

0.000 1.36

m 9.500

Attention: The coordinates refer to the image above. Values in Lux.

Grid: 1 x 2 Points

E_{av} [lx]	E_{min} [lx]	E_{max} [lx]	u0	E_{min} / E_{max}
1.34	1.31	1.36	0.98	0.96

MIDSTREAM LIGHTING LIMITED
 WESSEX HOUSE
 1 CHESHAM STREET
 LONDON, SW 1X 8ND, UNITED KINGDOM

Operator MIDSTREAM LIGHTING LIMITED
 Telephone +44 (0)207 584 8310
 Fax
 e-Mail info@midstreamlighting.com

Full Pitch / Spill Out - House 17 / Table (E, Perpendicular)



Position of surface in external scene:
 Marked point: (137.862 m, -
 148.129 m, 0.000 m)



1.000 1.17

0.000 1.21

m 3.500

Attention: The coordinates refer to the image above. Values in Lux.

Grid: 1 x 2 Points

E_{av} [lx]	E_{min} [lx]	E_{max} [lx]	u0	E_{min} / E_{max}
1.19	1.17	1.21	0.98	0.96

MIDSTREAM LIGHTING LIMITED
 WESSEX HOUSE
 1 CHESHAM STREET
 LONDON, SW 1X 8ND, UNITED KINGDOM

Operator MIDSTREAM LIGHTING LIMITED
 Telephone +44 (0)207 584 8310
 Fax
 e-Mail info@midstreamlighting.com

Full Pitch / Spill Out - House 18 / Table (E, Perpendicular)



Position of surface in external scene:
 Marked point: (127.153 m, -
 157.373 m, 1.000 m)



1.000 1.67

0.000 1.60

m 3.500

Attention: The coordinates refer to the image above. Values in Lux.

Grid: 1 x 2 Points

E_{av} [lx]	E_{min} [lx]	E_{max} [lx]	u0	E_{min} / E_{max}
1.64	1.60	1.67	0.98	0.96

MIDSTREAM LIGHTING LIMITED
 WESSEX HOUSE
 1 CHESHAM STREET
 LONDON, SW 1X 8ND, UNITED KINGDOM

Operator MIDSTREAM LIGHTING LIMITED
 Telephone +44 (0)207 584 8310
 Fax
 e-Mail info@midstreamlighting.com

Full Pitch / Spill Out - House 19 / Table (E, Perpendicular)



Position of surface in external scene:
 Marked point: (118.099 m, -
 156.395 m, 1.000 m)



1.000 1.90

0.000 1.82

m 4.000

Attention: The coordinates refer to the image above. Values in Lux.

Grid: 1 x 2 Points

E_{av} [lx]	E_{min} [lx]	E_{max} [lx]	u0	E_{min} / E_{max}
1.86	1.82	1.90	0.98	0.96

MIDSTREAM LIGHTING LIMITED
 WESSEX HOUSE
 1 CHESHAM STREET
 LONDON, SW 1X 8ND, UNITED KINGDOM

Operator MIDSTREAM LIGHTING LIMITED
 Telephone +44 (0)207 584 8310
 Fax
 e-Mail info@midstreamlighting.com

Full Pitch / Spill Out - House 20 / Table (E, Perpendicular)



Position of surface in external scene:
 Marked point: (107.345 m, -
 155.662 m, 1.000 m)



1.000 2.23

0.000 2.14

m 4.000

Attention: The coordinates refer to the image above. Values in Lux.

Grid: 1 x 2 Points

E_{av} [lx]
2.18

E_{min} [lx]
2.14

E_{max} [lx]
2.23

u0
0.98

E_{min} / E_{max}
0.96

MIDSTREAM LIGHTING LIMITED
 WESSEX HOUSE
 1 CHESHAM STREET
 LONDON, SW 1X 8ND, UNITED KINGDOM

Operator MIDSTREAM LIGHTING LIMITED
 Telephone +44 (0)207 584 8310
 Fax
 e-Mail info@midstreamlighting.com

Full Pitch / Spill Out - House 21 / Table (E, Perpendicular)



Position of surface in external scene:
 Marked point: (96.469 m, -155.051 m,
 1.000 m)



1.000 2.61

0.000 2.48

m **4.000**

Attention: The coordinates refer to the image above. Values in Lux.

Grid: 1 x 2 Points

E_{av} [lx]
2.54

E_{min} [lx]
2.48

E_{max} [lx]
2.61

u0
0.98

E_{min} / E_{max}
0.95

MIDSTREAM LIGHTING LIMITED
 WESSEX HOUSE
 1 CHESHAM STREET
 LONDON, SW 1X 8ND, UNITED KINGDOM

Operator MIDSTREAM LIGHTING LIMITED
 Telephone +44 (0)207 584 8310
 Fax
 e-Mail info@midstreamlighting.com

Full Pitch / Spill Out - House 22 / Table (E, Perpendicular)



Position of surface in external scene:
 Marked point: (84.104 m, -154.073 m,
 1.000 m)



1.000 3.07
0.000 2.92
 m **5.000**

Attention: The coordinates refer to the image above. Values in Lux.

Grid: 1 x 2 Points

E_{av} [lx]	E_{min} [lx]	E_{max} [lx]	$u0$	E_{min} / E_{max}
3.00	2.92	3.07	0.98	0.95

MIDSTREAM LIGHTING LIMITED
 WESSEX HOUSE
 1 CHESHAM STREET
 LONDON, SW 1X 8ND, UNITED KINGDOM

Operator MIDSTREAM LIGHTING LIMITED
 Telephone +44 (0)207 584 8310
 Fax
 e-Mail info@midstreamlighting.com

Full Pitch / Spill Out - House 23 / Table (E, Perpendicular)



Position of surface in external scene:
 Marked point: (73.995 m, -152.851 m,
 1.000 m)



1.000 3.62

0.000 3.45

m 3.500

Attention: The coordinates refer to the image above. Values in Lux.

Grid: 1 x 2 Points

E_{av} [lx]	E_{min} [lx]	E_{max} [lx]	u0	E_{min} / E_{max}
3.54	3.45	3.62	0.98	0.95

MIDSTREAM LIGHTING LIMITED
 WESSEX HOUSE
 1 CHESHAM STREET
 LONDON, SW 1X 8ND, UNITED KINGDOM

Operator MIDSTREAM LIGHTING LIMITED
 Telephone +44 (0)207 584 8310
 Fax
 e-Mail info@midstreamlighting.com

Full Pitch / Spill Out - House 24 / Table (E, Perpendicular)



Position of surface in external scene:
 Marked point: (64.097 m, -152.118 m,
 1.000 m)



1.000 4.11

0.000 3.90

m 3.500

Attention: The coordinates refer to the image above. Values in Lux.

Grid: 1 x 2 Points

E_{av} [lx]	E_{min} [lx]	E_{max} [lx]	u0	E_{min} / E_{max}
4.00	3.90	4.11	0.97	0.95

MIDSTREAM LIGHTING LIMITED
 WESSEX HOUSE
 1 CHESHAM STREET
 LONDON, SW 1X 8ND, UNITED KINGDOM

Operator MIDSTREAM LIGHTING LIMITED
 Telephone +44 (0)207 584 8310
 Fax
 e-Mail info@midstreamlighting.com

Full Pitch / Spill Out - House 25 / Table (E, Perpendicular)



Position of surface in external scene:
 Marked point: (50.621 m, -151.141 m,
 1.000 m)



1.000 4.75

0.000 4.50

m **5.000**

Attention: The coordinates refer to the image above. Values in Lux.

Grid: 1 x 2 Points

E_{av} [lx]	E_{min} [lx]	E_{max} [lx]	$u0$	E_{min} / E_{max}
4.62	4.50	4.75	0.97	0.95

MIDSTREAM LIGHTING LIMITED
 WESSEX HOUSE
 1 CHESHAM STREET
 LONDON, SW 1X 8ND, UNITED KINGDOM

Operator MIDSTREAM LIGHTING LIMITED
 Telephone +44 (0)207 584 8310
 Fax
 e-Mail info@midstreamlighting.com

Full Pitch / Spill Out - House 26 / Table (E, Perpendicular)



Position of surface in external scene:
 Marked point: (38.401 m, -149.919 m,
 1.000 m)



1.000 5.32

0.000 5.04

m **5.000**

Attention: The coordinates refer to the image above. Values in Lux.

Grid: 1 x 2 Points

E_{av} [lx]	E_{min} [lx]	E_{max} [lx]	$u0$	E_{min} / E_{max}
5.18	5.04	5.32	0.97	0.95

MIDSTREAM LIGHTING LIMITED
 WESSEX HOUSE
 1 CHESHAM STREET
 LONDON, SW 1X 8ND, UNITED KINGDOM

Operator MIDSTREAM LIGHTING LIMITED
 Telephone +44 (0)207 584 8310
 Fax
 e-Mail info@midstreamlighting.com

Full Pitch / Spill Out - House 27 / Table (E, Perpendicular)



Position of surface in external scene:
 Marked point: (24.714 m, -148.819 m,
 1.000 m)



1.000 5.76

0.000 5.47

m **5.000**

Attention: The coordinates refer to the image above. Values in Lux.

Grid: 1 x 2 Points

E_{av} [lx]	E_{min} [lx]	E_{max} [lx]	$u0$	E_{min} / E_{max}
5.61	5.47	5.76	0.97	0.95

MIDSTREAM LIGHTING LIMITED
 WESSEX HOUSE
 1 CHESHAM STREET
 LONDON, SW 1X 8ND, UNITED KINGDOM

Operator MIDSTREAM LIGHTING LIMITED
 Telephone +44 (0)207 584 8310
 Fax
 e-Mail info@midstreamlighting.com

Full Pitch / Spill Out - House 28 / Table (E, Perpendicular)



Position of surface in external scene:
 Marked point: (3.996 m, -147.274 m,
 1.000 m)



1.000 5.93
0.000 5.67
 m **8.500**

Attention: The coordinates refer to the image above. Values in Lux.

Grid: 1 x 2 Points

E_{av} [lx]	E_{min} [lx]	E_{max} [lx]	u0	E_{min} / E_{max}
5.80	5.67	5.93	0.98	0.96

MIDSTREAM LIGHTING LIMITED
 WESSEX HOUSE
 1 CHESHAM STREET
 LONDON, SW 1X 8ND, UNITED KINGDOM

Operator MIDSTREAM LIGHTING LIMITED
 Telephone +44 (0)207 584 8310
 Fax
 e-Mail info@midstreamlighting.com

Full Pitch / Spill Out - House 29 / Table (E, Perpendicular)



Position of surface in external scene:
 Marked point: (-9.729 m, -146.346 m,
 1.000 m)



1.000 6.08

0.000 5.82

m 4.500

Attention: The coordinates refer to the image above. Values in Lux.

Grid: 1 x 2 Points

E_{av} [lx]	E_{min} [lx]	E_{max} [lx]	$u0$	E_{min} / E_{max}
5.95	5.82	6.08	0.98	0.96

MIDSTREAM LIGHTING LIMITED
 WESSEX HOUSE
 1 CHESHAM STREET
 LONDON, SW 1X 8ND, UNITED KINGDOM

Operator MIDSTREAM LIGHTING LIMITED
 Telephone +44 (0)207 584 8310
 Fax
 e-Mail info@midstreamlighting.com

Full Pitch / Spill Out - House 30 / Table (E, Perpendicular)



Position of surface in external scene:
 Marked point: (-19.295 m, -143.006 m,
 1.000 m)



1.000 6.14

0.000 5.87

m 3.500

Attention: The coordinates refer to the image above. Values in Lux.

Grid: 1 x 2 Points

E_{av} [lx]
6.00

E_{min} [lx]
5.87

E_{max} [lx]
6.14

u0
0.98

E_{min} / E_{max}
0.95

MIDSTREAM LIGHTING LIMITED
 WESSEX HOUSE
 1 CHESHAM STREET
 LONDON, SW 1X 8ND, UNITED KINGDOM

Operator MIDSTREAM LIGHTING LIMITED
 Telephone +44 (0)207 584 8310
 Fax
 e-Mail info@midstreamlighting.com

Full Pitch / Spill Out - House 31 / Table (E, Perpendicular)



Position of surface in external scene:
 Marked point: (-25.649 m, -138.418 m,
 1.000 m)



1.000 6.01

0.000 5.72

m 3.500

Attention: The coordinates refer to the image above. Values in Lux.

Grid: 1 x 2 Points

E_{av} [lx]	E_{min} [lx]	E_{max} [lx]	u0	E_{min} / E_{max}
5.86	5.72	6.01	0.98	0.95

MIDSTREAM LIGHTING LIMITED
 WESSEX HOUSE
 1 CHESHAM STREET
 LONDON, SW 1X 8ND, UNITED KINGDOM

Operator MIDSTREAM LIGHTING LIMITED
 Telephone +44 (0)207 584 8310
 Fax
 e-Mail info@midstreamlighting.com

Full Pitch / Spill Out - House 32 / Table (E, Perpendicular)



Position of surface in external scene:
 Marked point: (-32.537 m, -132.752 m,
 1.000 m)



1.000 6.74

0.000 6.41

m 3.500

Attention: The coordinates refer to the image above. Values in Lux.

Grid: 1 x 2 Points

E_{av} [lx]
6.57

E_{min} [lx]
6.41

E_{max} [lx]
6.74

u0
0.97

E_{min} / E_{max}
0.95

MIDSTREAM LIGHTING LIMITED
 WESSEX HOUSE
 1 CHESHAM STREET
 LONDON, SW 1X 8ND, UNITED KINGDOM

Operator MIDSTREAM LIGHTING LIMITED
 Telephone +44 (0)207 584 8310
 Fax
 e-Mail info@midstreamlighting.com

Full Pitch / Spill Out - House 33 / Table (E, Perpendicular)



Position of surface in external scene:
 Marked point: (-36.002 m, -118.095 m,
 1.000 m)



1.000 2.00
0.000 1.92
 m **5.000**

Attention: The coordinates refer to the image above. Values in Lux.

Grid: 1 x 2 Points

E_{av} [lx]	E_{min} [lx]	E_{max} [lx]	$u0$	E_{min} / E_{max}
1.96	1.92	2.00	0.98	0.96

MIDSTREAM LIGHTING LIMITED
 WESSEX HOUSE
 1 CHESHAM STREET
 LONDON, SW 1X 8ND, UNITED KINGDOM

Operator MIDSTREAM LIGHTING LIMITED
 Telephone +44 (0)207 584 8310
 Fax
 e-Mail info@midstreamlighting.com

Full Pitch / Spill Out - House 34 / Table (E, Perpendicular)



Position of surface in external scene:
 Marked point: (-38.113 m, -98.543 m,
 1.000 m)



1.000 3.25

0.000 3.11

m 5.000

Attention: The coordinates refer to the image above. Values in Lux.

Grid: 1 x 2 Points

E_{av} [lx]
3.18

E_{min} [lx]
3.11

E_{max} [lx]
3.25

$u0$
0.98

E_{min} / E_{max}
0.96

MIDSTREAM LIGHTING LIMITED
 WESSEX HOUSE
 1 CHESHAM STREET
 LONDON, SW 1X 8ND, UNITED KINGDOM

Operator MIDSTREAM LIGHTING LIMITED
 Telephone +44 (0)207 584 8310
 Fax
 e-Mail info@midstreamlighting.com

Full Pitch / Spill Out - House 35 / Table (E, Perpendicular)



Position of surface in external scene:
 Marked point: (-43.779 m, -72.992 m,
 1.000 m)



1.000 6.47

0.000 6.19

m **5.000**

Attention: The coordinates refer to the image above. Values in Lux.

Grid: 1 x 2 Points

E_{av} [lx]
6.33

E_{min} [lx]
6.19

E_{max} [lx]
6.47

u_0
0.98

E_{min} / E_{max}
0.96

MIDSTREAM LIGHTING LIMITED
 WESSEX HOUSE
 1 CHESHAM STREET
 LONDON, SW 1X 8ND, UNITED KINGDOM

Operator MIDSTREAM LIGHTING LIMITED
 Telephone +44 (0)207 584 8310
 Fax
 e-Mail info@midstreamlighting.com

Full Pitch / Spill Out - House 36 / Table (E, Perpendicular)



Position of surface in external scene:
 Marked point: (-51.960 m, -51.388 m,
 1.000 m)



1.000 21

0.000 21

m 5.000

Attention: The coordinates refer to the image above. Values in Lux.

Grid: 1 x 2 Points

E_{av} [lx]
21

E_{min} [lx]
21

E_{max} [lx]
21

$u0$
0.98

E_{min} / E_{max}
0.95

MIDSTREAM LIGHTING LIMITED
 WESSEX HOUSE
 1 CHESHAM STREET
 LONDON, SW 1X 8ND, UNITED KINGDOM

Operator MIDSTREAM LIGHTING LIMITED
 Telephone +44 (0)207 584 8310
 Fax
 e-Mail info@midstreamlighting.com

Full Pitch / Spill Out - House 37 / Table (E, Perpendicular)



Position of surface in external scene:
 Marked point: (-61.264 m, -29.524 m,
 1.000 m)



1.000 56
0.000 55
 m **5.000**

Attention: The coordinates refer to the image above. Values in Lux.

Grid: 1 x 2 Points

E_{av} [lx]	E_{min} [lx]	E_{max} [lx]	$u0$	E_{min} / E_{max}
55	55	56	0.99	0.98

MIDSTREAM LIGHTING LIMITED
 WESSEX HOUSE
 1 CHESHAM STREET
 LONDON, SW 1X 8ND, UNITED KINGDOM

Operator MIDSTREAM LIGHTING LIMITED
 Telephone +44 (0)207 584 8310
 Fax
 e-Mail info@midstreamlighting.com

Full Pitch / Spill Out - House 38 / Table (E, Perpendicular)



Position of surface in external scene:
 Marked point: (-71.091 m, -9.441 m,
 1.000 m)



1.000 50

0.000 48

m 4.500

Attention: The coordinates refer to the image above. Values in Lux.

Grid: 1 x 2 Points

E_{av} [lx]	E_{min} [lx]	E_{max} [lx]	$u0$	E_{min} / E_{max}
49	48	50	0.98	0.96

MIDSTREAM LIGHTING LIMITED
 WESSEX HOUSE
 1 CHESHAM STREET
 LONDON, SW 1X 8ND, UNITED KINGDOM

Operator MIDSTREAM LIGHTING LIMITED
 Telephone +44 (0)207 584 8310
 Fax
 e-Mail info@midstreamlighting.com

Full Pitch / Spill Out - House 39 / Table (E, Perpendicular)



Position of surface in external scene:
 Marked point: (-78.714 m, 3.522 m,
 1.000 m)



1.000 34

0.000 32

m 6.000

Attention: The coordinates refer to the image above. Values in Lux.

Grid: 1 x 2 Points

E_{av} [lx]
33

E_{min} [lx]
32

E_{max} [lx]
34

u_0
0.98

E_{min} / E_{max}
0.95

MIDSTREAM LIGHTING LIMITED
 WESSEX HOUSE
 1 CHESHAM STREET
 LONDON, SW 1X 8ND, UNITED KINGDOM

Operator MIDSTREAM LIGHTING LIMITED
 Telephone +44 (0)207 584 8310
 Fax
 e-Mail info@midstreamlighting.com

Full Pitch / Spill Out - House 40 / Table (E, Perpendicular)



Position of surface in external scene:
 Marked point: (-88.370 m, 17.246 m,
 1.000 m)



1.000 18
0.000 18
 m **5.000**

Attention: The coordinates refer to the image above. Values in Lux.

Grid: 1 x 2 Points

E_{av} [lx]	E_{min} [lx]	E_{max} [lx]	$u0$	E_{min} / E_{max}
18	18	18	0.99	0.97

MIDSTREAM LIGHTING LIMITED
 WESSEX HOUSE
 1 CHESHAM STREET
 LONDON, SW 1X 8ND, UNITED KINGDOM

Operator MIDSTREAM LIGHTING LIMITED
 Telephone +44 (0)207 584 8310
 Fax
 e-Mail info@midstreamlighting.com

Full Pitch / Spill Out - House 41 / Table (E, Perpendicular)



Position of surface in external scene:
 Marked point: (-93.814 m, 31.466 m,
 1.000 m)



1.000 11
0.000 11
 m **5.000**

Attention: The coordinates refer to the image above. Values in Lux.

Grid: 1 x 2 Points

E_{av} [lx]	E_{min} [lx]	E_{max} [lx]	$u0$	E_{min} / E_{max}
11	11	11	0.98	0.97

MIDSTREAM LIGHTING LIMITED
 WESSEX HOUSE
 1 CHESHAM STREET
 LONDON, SW 1X 8ND, UNITED KINGDOM

Operator MIDSTREAM LIGHTING LIMITED
 Telephone +44 (0)207 584 8310
 Fax
 e-Mail info@midstreamlighting.com

Full Pitch / Spill Out - House 42 / Table (E, Perpendicular)



Position of surface in external scene:
 Marked point: (-98.702 m, 43.908 m,
 1.000 m)



1.000 7.02

0.000 6.76

m **5.000**

Attention: The coordinates refer to the image above. Values in Lux.

Grid: 1 x 2 Points

E_{av} [lx]	E_{min} [lx]	E_{max} [lx]	$u0$	E_{min} / E_{max}
6.89	6.76	7.02	0.98	0.96

MIDSTREAM LIGHTING LIMITED
 WESSEX HOUSE
 1 CHESHAM STREET
 LONDON, SW 1X 8ND, UNITED KINGDOM

Operator MIDSTREAM LIGHTING LIMITED
 Telephone +44 (0)207 584 8310
 Fax
 e-Mail info@midstreamlighting.com

Full Pitch / Spill Out - House 43 / Table (E, Perpendicular)



Position of surface in external scene:
 Marked point: (-101.368 m, 54.906 m,
 1.000 m)



1.000 4.92

0.000 4.74

m **5.000**

Attention: The coordinates refer to the image above. Values in Lux.

Grid: 1 x 2 Points

E_{av} [lx]	E_{min} [lx]	E_{max} [lx]	$u0$	E_{min} / E_{max}
4.83	4.74	4.92	0.98	0.96

MIDSTREAM LIGHTING LIMITED
 WESSEX HOUSE
 1 CHESHAM STREET
 LONDON, SW 1X 8ND, UNITED KINGDOM

Operator MIDSTREAM LIGHTING LIMITED
 Telephone +44 (0)207 584 8310
 Fax
 e-Mail info@midstreamlighting.com

Half Pitch 1 / Planning data

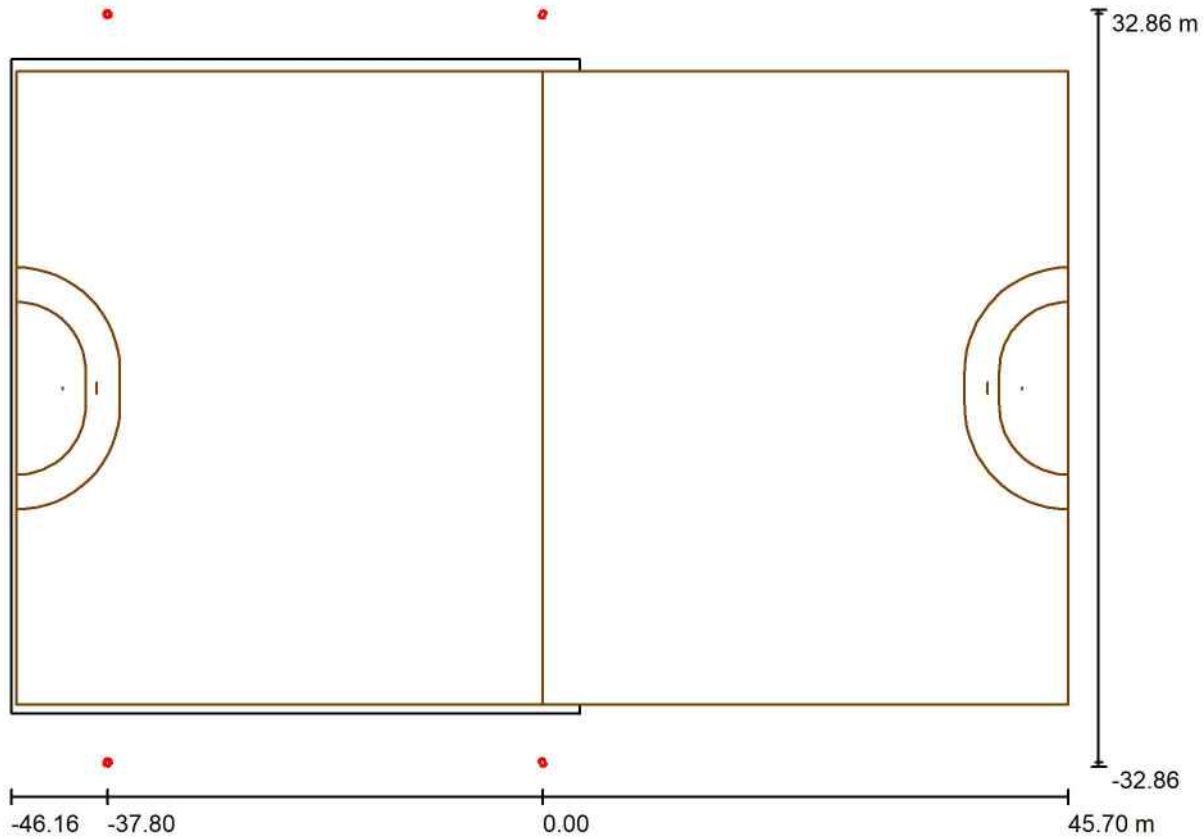

Light loss factor: 0.90, ULR (Upward Light Ratio): 0.5%

Scale 1:657

Luminaire Parts List

No.	Pieces	Designation (Correction Factor)	Φ (Luminaire) [lm]	Φ (Lamps) [lm]	P [W]
1	10	MIDSTREAM - Modus S1500 NS (5000K) (1.000)	172248	172245	1500.0
2	2	MIDSTREAM - Modus S1500 WS (5000K) (1.000)	172247	172246	1500.0
Total:			2066973	Total: 2066942	18000.0

MIDSTREAM LIGHTING LIMITED
WESSEX HOUSE
1 CHESHAM STREET
LONDON, SW 1X 8ND, UNITED KINGDOM

Operator MIDSTREAM LIGHTING LIMITED
Telephone +44 (0)207 584 8310
Fax
e-Mail info@midstreamlighting.com

Half Pitch 1 / Luminaire parts list

10 Pieces MIDSTREAM - Modus S1500 NS (5000K)
Article No.:
Luminous flux (Luminaire): 172248 lm
Luminous flux (Lamps): 172245 lm
Luminaire Wattage: 1500.0 W
Luminaire classification according to CIE: 100
CIE flux code: 24 67 95 100 100
Fitting: 1 x LED (Correction Factor 1.000).

See our luminaire catalog
for an image of the
luminaire.

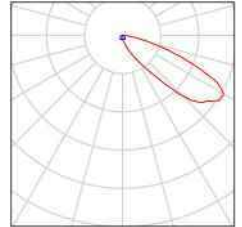

2 Pieces MIDSTREAM - Modus S1500 WS (5000K)
Article No.:
Luminous flux (Luminaire): 172247 lm
Luminous flux (Lamps): 172246 lm
Luminaire Wattage: 1500.0 W
Luminaire classification according to CIE: 100
CIE flux code: 31 67 95 100 100
Fitting: 1 x LED (Correction Factor 1.000).

See our luminaire catalog
for an image of the
luminaire.

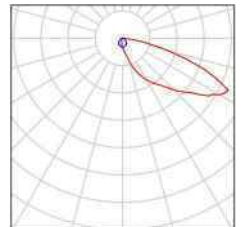

MIDSTREAM LIGHTING LIMITED
 WESSEX HOUSE
 1 CHESHAM STREET
 LONDON, SW 1X 8ND, UNITED KINGDOM

Operator MIDSTREAM LIGHTING LIMITED
 Telephone +44 (0)207 584 8310
 Fax
 e-Mail info@midstreamlighting.com

Half Pitch 1 / Luminaires (layout plan)

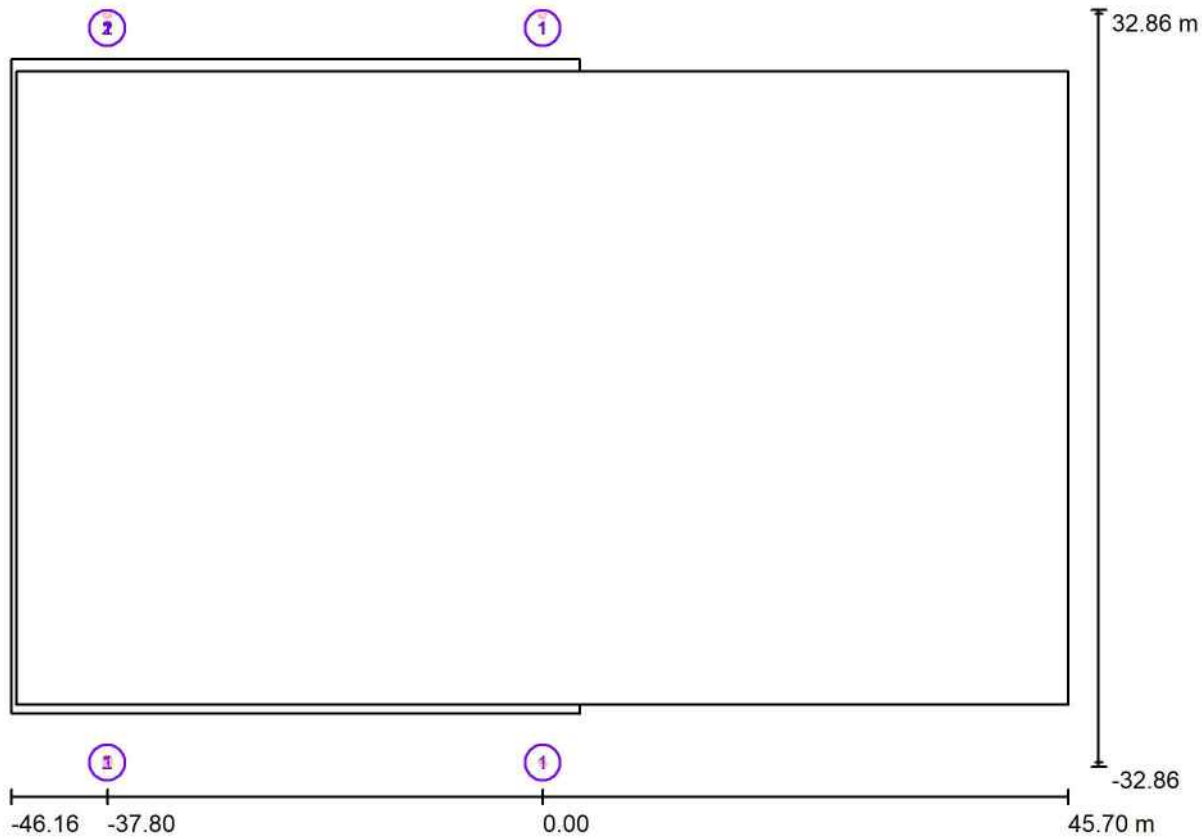

Scale 1 : 657

Luminaire Parts List

No.	Pieces	Designation
1	10	MIDSTREAM - Modus S1500 NS (5000K)
2	2	MIDSTREAM - Modus S1500 WS (5000K)

MIDSTREAM LIGHTING LIMITED
 WESSEX HOUSE
 1 CHESHAM STREET
 LONDON, SW 1X 8ND, UNITED KINGDOM

Operator MIDSTREAM LIGHTING LIMITED
 Telephone +44 (0)207 584 8310
 Fax
 e-Mail info@midstreamlighting.com

Half Pitch 1 / Luminaires (coordinates list)

MIDSTREAM - Modus S1500 NS (5000K)

172248 lm, 1500.0 W, 1 x 1 x LED (Correction Factor 1.000).

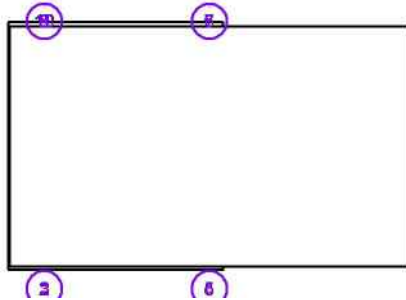

No.	Position [m]			Rotation [°]		
	X	Y	Z	X	Y	Z
1	-37.800	-32.500	15.000	0.0	-5.6	93.3
2	-37.800	-32.500	15.000	0.0	-7.8	63.8
3	-37.800	-32.500	15.000	0.0	-6.5	23.5
4	0.000	-32.500	16.000	0.0	-5.6	125.0
5	0.000	-32.500	16.000	0.0	-5.4	100.4
6	0.000	32.500	16.000	0.0	-5.6	-125.0
7	0.000	32.500	16.000	0.0	-5.4	-100.4
8	-37.800	32.500	16.000	0.0	-4.2	-92.8
9	-37.800	32.500	16.000	0.0	-6.5	-63.2
10	-37.800	32.500	16.000	0.0	-5.1	-23.5

MIDSTREAM LIGHTING LIMITED
 WESSEX HOUSE
 1 CHESHAM STREET
 LONDON, SW 1X 8ND, UNITED KINGDOM

Operator MIDSTREAM LIGHTING LIMITED
 Telephone +44 (0)207 584 8310
 Fax
 e-Mail info@midstreamlighting.com

Half Pitch 1 / Luminaires (coordinates list)

MIDSTREAM - Modus S1500 WS (5000K)
 172247 lm, 1500.0 W, 1 x 1 x LED (Correction Factor 1.000).

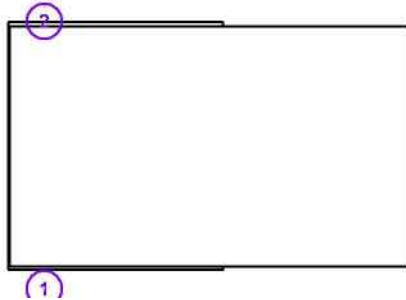

No.	Position [m]			Rotation [°]		
	X	Y	Z	X	Y	Z
1	-37.800	-32.500	15.000	0.0	0.1	98.3
2	-37.800	32.500	16.000	0.0	1.5	-98.3

MIDSTREAM LIGHTING LIMITED
 WESSEX HOUSE
 1 CHESHAM STREET
 LONDON, SW 1X 8ND, UNITED KINGDOM

Operator MIDSTREAM LIGHTING LIMITED
 Telephone +44 (0)207 584 8310
 Fax
 e-Mail info@midstreamlighting.com

Half Pitch 1 / GR Observer (Results Overview)

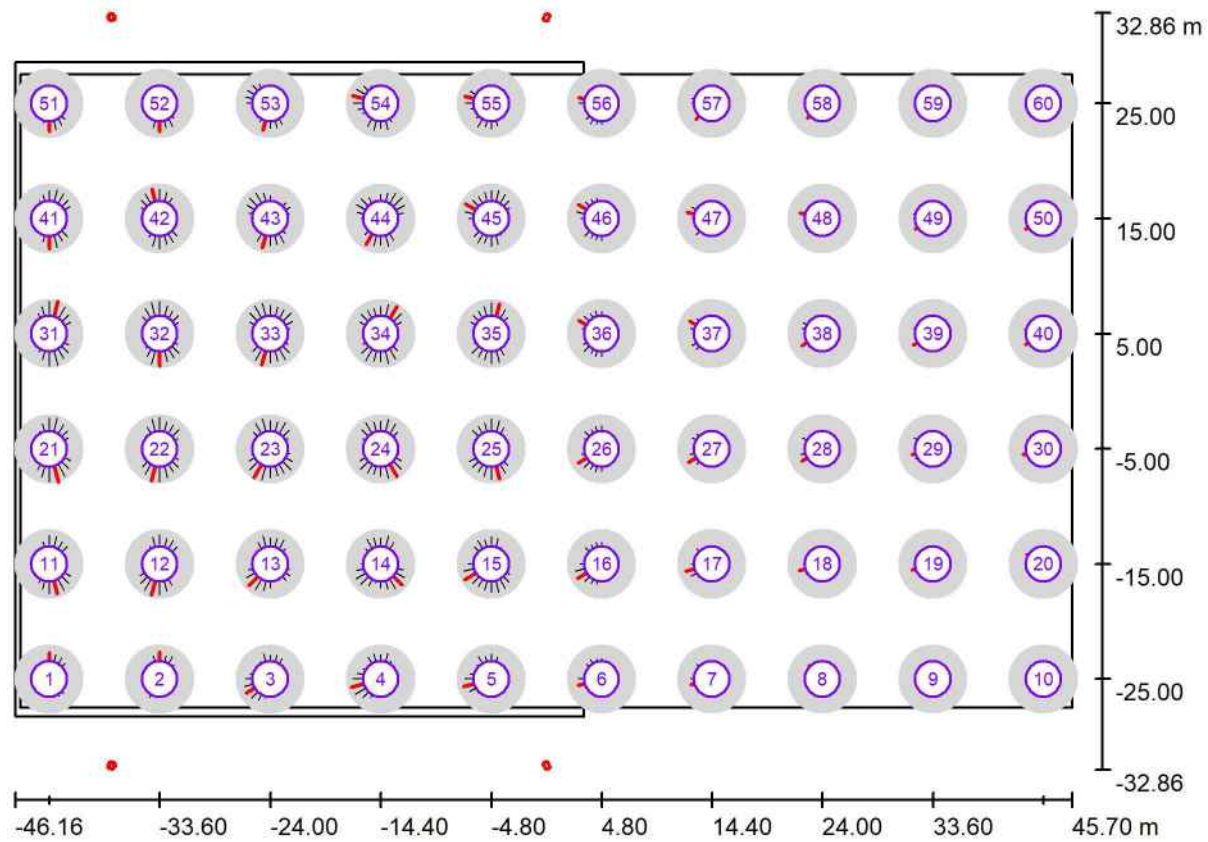

Scale 1 : 657

GR Observerlist

No.	Designation	Position [m]			Viewing sector [°]			Slope angle	Max
		X	Y	Z	Start	End	Increment		
1	GR Observer 1	-43.200	-25.000	1.500	0.0	360.0	15.0	-2.0	37 ²⁾
2	GR Observer 2	-33.600	-25.000	1.500	0.0	360.0	15.0	-2.0	38 ²⁾
3	GR Observer 3	-24.000	-25.000	1.500	0.0	360.0	15.0	-2.0	39 ²⁾
4	GR Observer 4	-14.400	-25.000	1.500	0.0	360.0	15.0	-2.0	43 ²⁾

MIDSTREAM LIGHTING LIMITED
 WESSEX HOUSE
 1 CHESHAM STREET
 LONDON, SW 1X 8ND, UNITED KINGDOM

Operator MIDSTREAM LIGHTING LIMITED
 Telephone +44 (0)207 584 8310
 Fax
 e-Mail info@midstreamlighting.com

Half Pitch 1 / GR Observer (Results Overview)

GR Observerlist

No.	Designation	Position [m]			Viewing sector [°]				Max
		X	Y	Z	Start	End	Increment	Slope angle	
5	GR Observer 5	-4.800	-25.000	1.500	0.0	360.0	15.0	-2.0	40 ²⁾
6	GR Observer 6	4.800	-25.000	1.500	0.0	360.0	15.0	-2.0	34 ²⁾
7	GR Observer 7	14.400	-25.000	1.500	0.0	360.0	15.0	-2.0	30 ²⁾
8	GR Observer 8	24.000	-25.000	1.500	0.0	360.0	15.0	-2.0	27 ²⁾
9	GR Observer 9	33.600	-25.000	1.500	0.0	360.0	15.0	-2.0	24 ²⁾
10	GR Observer 10	43.200	-25.000	1.500	0.0	360.0	15.0	-2.0	23 ²⁾
11	GR Observer 11	-43.200	-15.000	1.500	0.0	360.0	15.0	-2.0	43 ²⁾
12	GR Observer 12	-33.600	-15.000	1.500	0.0	360.0	15.0	-2.0	44 ²⁾
13	GR Observer 13	-24.000	-15.000	1.500	0.0	360.0	15.0	-2.0	42 ²⁾
14	GR Observer 14	-14.400	-15.000	1.500	0.0	360.0	15.0	-2.0	41 ²⁾
15	GR Observer 15	-4.800	-15.000	1.500	0.0	360.0	15.0	-2.0	43 ²⁾
16	GR Observer 16	4.800	-15.000	1.500	0.0	360.0	15.0	-2.0	40 ²⁾
17	GR Observer 17	14.400	-15.000	1.500	0.0	360.0	15.0	-2.0	37 ²⁾
18	GR Observer 18	24.000	-15.000	1.500	0.0	360.0	15.0	-2.0	34 ²⁾
19	GR Observer 19	33.600	-15.000	1.500	0.0	360.0	15.0	-2.0	30 ²⁾
20	GR Observer 20	43.200	-15.000	1.500	0.0	360.0	15.0	-2.0	27 ²⁾
21	GR Observer 21	-43.200	-5.000	1.500	0.0	360.0	15.0	-2.0	48 ²⁾
22	GR Observer 22	-33.600	-5.000	1.500	0.0	360.0	15.0	-2.0	46 ²⁾
23	GR Observer 23	-24.000	-5.000	1.500	0.0	360.0	15.0	-2.0	46 ²⁾
24	GR Observer 24	-14.400	-5.000	1.500	0.0	360.0	15.0	-2.0	44 ²⁾
25	GR Observer 25	-4.800	-5.000	1.500	0.0	360.0	15.0	-2.0	43 ²⁾
26	GR Observer 26	4.800	-5.000	1.500	0.0	360.0	15.0	-2.0	38 ²⁾
27	GR Observer 27	14.400	-5.000	1.500	0.0	360.0	15.0	-2.0	37 ²⁾
28	GR Observer 28	24.000	-5.000	1.500	0.0	360.0	15.0	-2.0	33 ²⁾
29	GR Observer 29	33.600	-5.000	1.500	0.0	360.0	15.0	-2.0	30 ²⁾
30	GR Observer 30	43.200	-5.000	1.500	0.0	360.0	15.0	-2.0	29 ²⁾
31	GR Observer 31	-43.200	5.000	1.500	0.0	360.0	15.0	-2.0	46 ²⁾
32	GR Observer 32	-33.600	5.000	1.500	0.0	360.0	15.0	-2.0	45 ²⁾
33	GR Observer 33	-24.000	5.000	1.500	0.0	360.0	15.0	-2.0	45 ²⁾
34	GR Observer 34	-14.400	5.000	1.500	0.0	360.0	15.0	-2.0	44 ²⁾
35	GR Observer 35	-4.800	5.000	1.500	0.0	360.0	15.0	-2.0	43 ²⁾
36	GR Observer 36	4.800	5.000	1.500	0.0	360.0	15.0	-2.0	37 ²⁾
37	GR Observer 37	14.400	5.000	1.500	0.0	360.0	15.0	-2.0	35 ²⁾
38	GR Observer 38	24.000	5.000	1.500	0.0	360.0	15.0	-2.0	33 ²⁾
39	GR Observer 39	33.600	5.000	1.500	0.0	360.0	15.0	-2.0	32 ²⁾
40	GR Observer 40	43.200	5.000	1.500	0.0	360.0	15.0	-2.0	28 ²⁾

MIDSTREAM LIGHTING LIMITED
 WESSEX HOUSE
 1 CHESHAM STREET
 LONDON, SW 1X 8ND, UNITED KINGDOM

Operator MIDSTREAM LIGHTING LIMITED
 Telephone +44 (0)207 584 8310
 Fax
 e-Mail info@midstreamlighting.com

Half Pitch 1 / GR Observer (Results Overview)

GR Observerlist

No.	Designation	Position [m]			Viewing sector [°]			Slope angle	Max
		X	Y	Z	Start	End	Increment		
41	GR Observer 41	-43.200	15.000	1.500	0.0	360.0	15.0	-2.0	42 ²⁾
42	GR Observer 42	-33.600	15.000	1.500	0.0	360.0	15.0	-2.0	42 ²⁾
43	GR Observer 43	-24.000	15.000	1.500	0.0	360.0	15.0	-2.0	42 ²⁾
44	GR Observer 44	-14.400	15.000	1.500	0.0	360.0	15.0	-2.0	41 ²⁾
45	GR Observer 45	-4.800	15.000	1.500	0.0	360.0	15.0	-2.0	42 ²⁾
46	GR Observer 46	4.800	15.000	1.500	0.0	360.0	15.0	-2.0	38 ²⁾
47	GR Observer 47	14.400	15.000	1.500	0.0	360.0	15.0	-2.0	35 ²⁾
48	GR Observer 48	24.000	15.000	1.500	0.0	360.0	15.0	-2.0	32 ²⁾
49	GR Observer 49	33.600	15.000	1.500	0.0	360.0	15.0	-2.0	29 ²⁾
50	GR Observer 50	43.200	15.000	1.500	0.0	360.0	15.0	-2.0	29 ²⁾
51	GR Observer 51	-43.200	25.000	1.500	0.0	360.0	15.0	-2.0	39 ²⁾
52	GR Observer 52	-33.600	25.000	1.500	0.0	360.0	15.0	-2.0	39 ²⁾
53	GR Observer 53	-24.000	25.000	1.500	0.0	360.0	15.0	-2.0	39 ²⁾
54	GR Observer 54	-14.400	25.000	1.500	0.0	360.0	15.0	-2.0	41 ²⁾
55	GR Observer 55	-4.800	25.000	1.500	0.0	360.0	15.0	-2.0	38 ²⁾
56	GR Observer 56	4.800	25.000	1.500	0.0	360.0	15.0	-2.0	33 ²⁾
57	GR Observer 57	14.400	25.000	1.500	0.0	360.0	15.0	-2.0	31 ²⁾
58	GR Observer 58	24.000	25.000	1.500	0.0	360.0	15.0	-2.0	29 ²⁾
59	GR Observer 59	33.600	25.000	1.500	0.0	360.0	15.0	-2.0	25 ²⁾
60	GR Observer 60	43.200	25.000	1.500	0.0	360.0	15.0	-2.0	24 ²⁾

2) The calculated equivalent veil luminance of the environment is based on the assumption of a complete diffuse reflection behavior of the environment (acc. EN 12464-2).

MIDSTREAM LIGHTING LIMITED
WESSEX HOUSE
1 CHESHAM STREET
LONDON, SW 1X 8ND, UNITED KINGDOM

Operator MIDSTREAM LIGHTING LIMITED
Telephone +44 (0)207 584 8310
Fax
e-Mail info@midstreamlighting.com

Half Pitch 1 / 3D Rendering



MIDSTREAM LIGHTING LIMITED
WESSEX HOUSE
1 CHESHAM STREET
LONDON, SW 1X 8ND, UNITED KINGDOM

Operator MIDSTREAM LIGHTING LIMITED
Telephone +44 (0)207 584 8310
Fax
e-Mail info@midstreamlighting.com

Half Pitch 1 / False Color Rendering

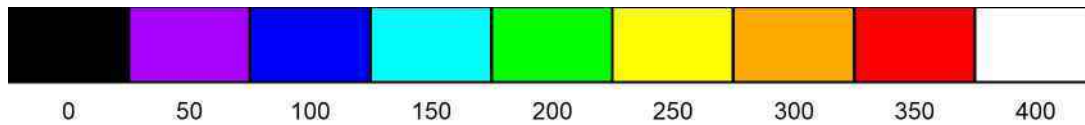
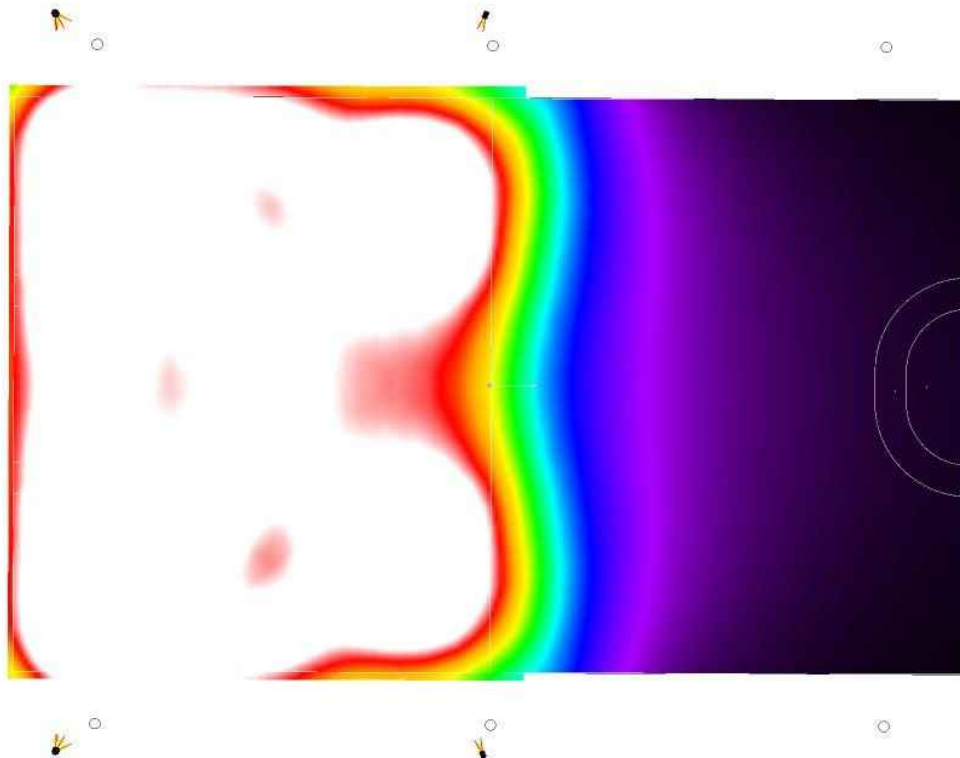

lx



MIDSTREAM LIGHTING LIMITED
 WESSEX HOUSE
 1 CHESHAM STREET
 LONDON, SW 1X 8ND, UNITED KINGDOM

Operator MIDSTREAM LIGHTING LIMITED
 Telephone +44 (0)207 584 8310
 Fax
 e-Mail info@midstreamlighting.com

Half Pitch 1 / Half Pitch 1 / Summary

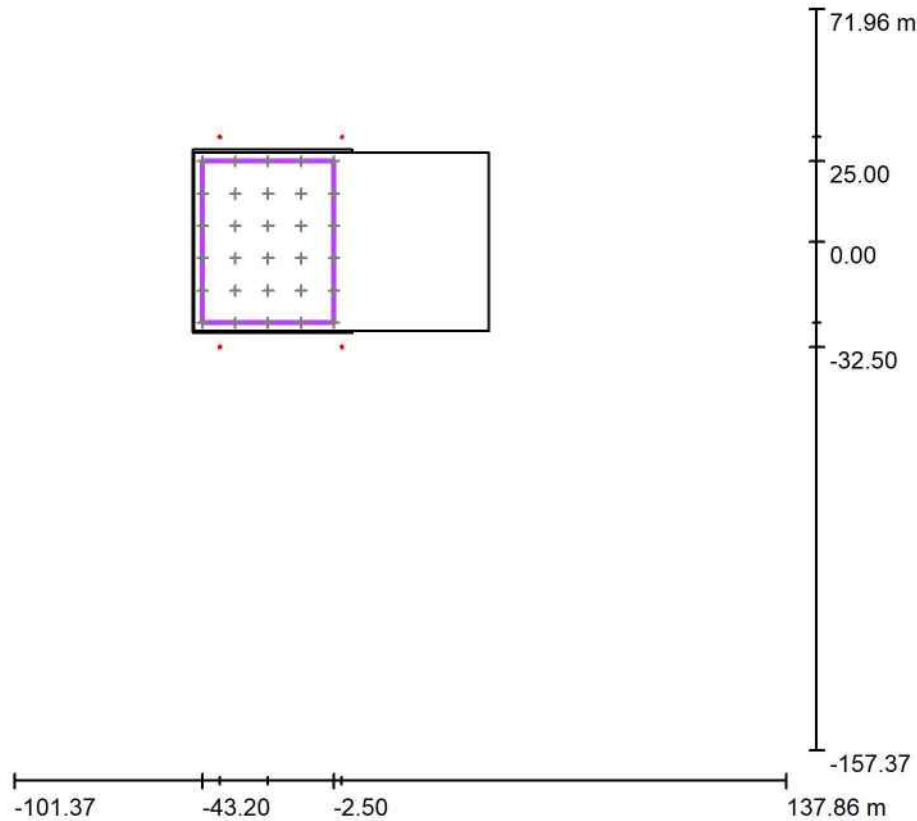

Scale 1 : 2343

Position: (-22.850 m, 0.000 m, 0.000 m)
 Size: (40.700 m, 50.000 m)
 Rotation: (0.0°, 0.0°, 0.0°)
 Type: Normal, Grid: 5 x 6 Points

Results overview

No.	Type	E_{av} [lx]	E_{min} [lx]	E_{max} [lx]	u_0	E_{min} / E_{max}	$E_{h,m} / E_m$	H [m]	Camera
1	horizontal	456	341	602	0.75	0.57	/	0.000	/

$E_{h,m} / E_m$ = Relationship between middle horizontal and vertical illuminance, H = Measuring Height

MIDSTREAM LIGHTING LIMITED
 WESSEX HOUSE
 1 CHESHAM STREET
 LONDON, SW 1X 8ND, UNITED KINGDOM

Operator MIDSTREAM LIGHTING LIMITED
 Telephone +44 (0)207 584 8310
 Fax
 e-Mail info@midstreamlighting.com

Half Pitch 1 / Half Pitch 1 / Value Chart (E, Horizontal)

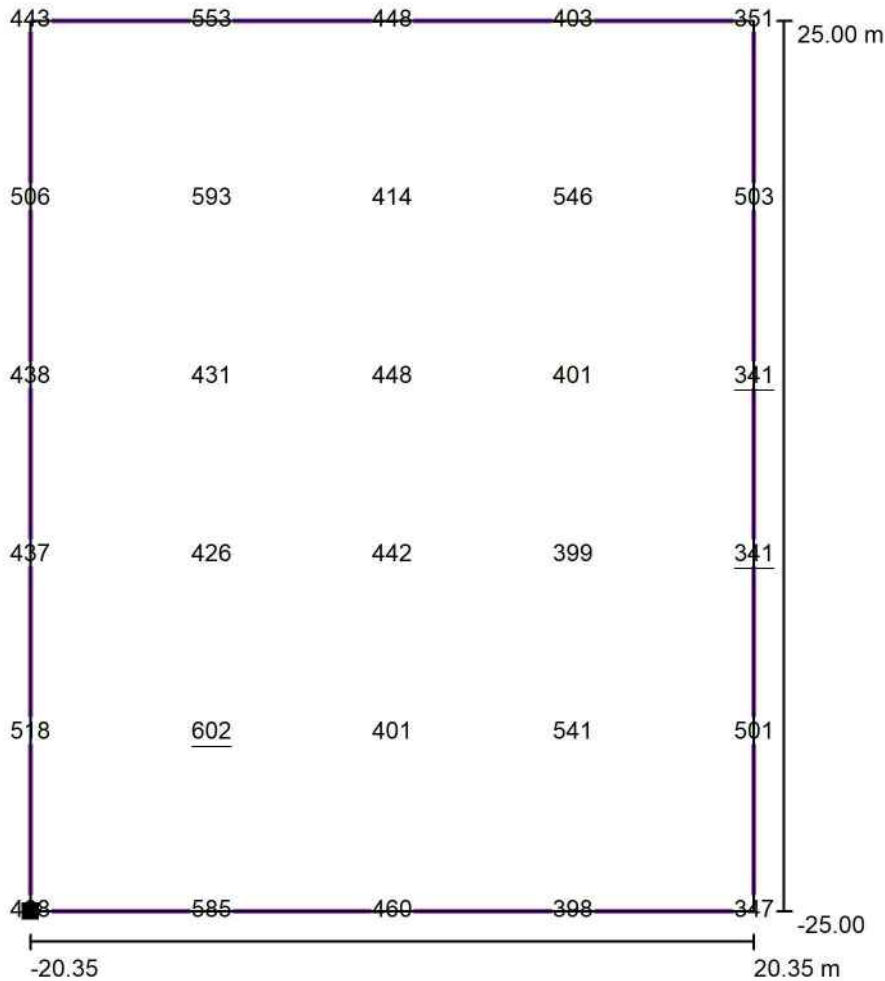

Values in Lux, Scale 1 : 425

Position of surface in external scene:
 Marked point: (-43.200 m, -25.000 m,
 0.000 m)



Grid: 5 x 6 Points

E_{av} [lx]	E_{min} [lx]	E_{max} [lx]	u0	E_{min} / E_{max}
456	341	602	0.75	0.57

MIDSTREAM LIGHTING LIMITED
 WESSEX HOUSE
 1 CHESHAM STREET
 LONDON, SW 1X 8ND, UNITED KINGDOM

Operator MIDSTREAM LIGHTING LIMITED
 Telephone +44 (0)207 584 8310
 Fax
 e-Mail info@midstreamlighting.com

Half Pitch 1 / Spill Out - House 1 / Table (E, Perpendicular)



Position of surface in external scene:
 Marked point: (105.514 m, 71.961 m,
 0.000 m)



1.000 2.09

0.000 2.16

m **5.000**

Attention: The coordinates refer to the image above. Values in Lux.

Grid: 1 x 2 Points

E_{av} [lx]
2.12

E_{min} [lx]
2.09

E_{max} [lx]
2.16

$u0$
0.98

E_{min} / E_{max}
0.97

MIDSTREAM LIGHTING LIMITED
 WESSEX HOUSE
 1 CHESHAM STREET
 LONDON, SW 1X 8ND, UNITED KINGDOM

Operator MIDSTREAM LIGHTING LIMITED
 Telephone +44 (0)207 584 8310
 Fax
 e-Mail info@midstreamlighting.com

Half Pitch 1 / Spill Out - House 2 / Table (E, Perpendicular)



Position of surface in external scene:
 Marked point: (109.320 m, 43.252 m,
 0.000 m)



1.000 3.30

0.000 3.42

m **5.000**

Attention: The coordinates refer to the image above. Values in Lux.

Grid: 1 x 2 Points

E_{av} [lx]	E_{min} [lx]	E_{max} [lx]	$u0$	E_{min} / E_{max}
3.36	3.30	3.42	0.98	0.96

MIDSTREAM LIGHTING LIMITED
 WESSEX HOUSE
 1 CHESHAM STREET
 LONDON, SW 1X 8ND, UNITED KINGDOM

Operator MIDSTREAM LIGHTING LIMITED
 Telephone +44 (0)207 584 8310
 Fax
 e-Mail info@midstreamlighting.com

Half Pitch 1 / Spill Out - House 3 / Table (E, Perpendicular)



Position of surface in external scene:
 Marked point: (111.607 m, 27.470 m,
 0.000 m)



1.000 3.64

0.000 3.76

m **4.000**

Attention: The coordinates refer to the image above. Values in Lux.

Grid: 1 x 2 Points

E_{av} [lx]	E_{min} [lx]	E_{max} [lx]	u0	E_{min} / E_{max}
3.70	3.64	3.76	0.98	0.97

MIDSTREAM LIGHTING LIMITED
 WESSEX HOUSE
 1 CHESHAM STREET
 LONDON, SW 1X 8ND, UNITED KINGDOM

Operator MIDSTREAM LIGHTING LIMITED
 Telephone +44 (0)207 584 8310
 Fax
 e-Mail info@midstreamlighting.com

Half Pitch 1 / Spill Out - House 4 / Table (E, Perpendicular)



Position of surface in external scene:
 Marked point: (112.554 m, 17.411 m,
 0.000 m)

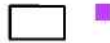

1.000 3.68

0.000 3.81

m **5.000**

Attention: The coordinates refer to the image above. Values in Lux.

Grid: 1 x 2 Points

E_{av} [lx]	E_{min} [lx]	E_{max} [lx]	$u0$	E_{min} / E_{max}
3.74	3.68	3.81	0.98	0.97

MIDSTREAM LIGHTING LIMITED
 WESSEX HOUSE
 1 CHESHAM STREET
 LONDON, SW 1X 8ND, UNITED KINGDOM

Operator MIDSTREAM LIGHTING LIMITED
 Telephone +44 (0)207 584 8310
 Fax
 e-Mail info@midstreamlighting.com

Half Pitch 1 / Spill Out - House 5 / Table (E, Perpendicular)



Position of surface in external scene:
 Marked point: (112.921 m, 4.824 m,
 0.000 m)

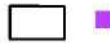

1.000 3.57

0.000 3.72

m **5.000**

Attention: The coordinates refer to the image above. Values in Lux.

Grid: 1 x 2 Points

E_{av} [lx]	E_{min} [lx]	E_{max} [lx]	$u0$	E_{min} / E_{max}
3.65	3.57	3.72	0.98	0.96

MIDSTREAM LIGHTING LIMITED
 WESSEX HOUSE
 1 CHESHAM STREET
 LONDON, SW 1X 8ND, UNITED KINGDOM

Operator MIDSTREAM LIGHTING LIMITED
 Telephone +44 (0)207 584 8310
 Fax
 e-Mail info@midstreamlighting.com

Half Pitch 1 / Spill Out - House 6 / Table (E, Perpendicular)



Position of surface in external scene:
 Marked point: (114.805 m, -9.359 m,
 0.000 m)



1.000 3.23

0.000 3.38

m **4.000**

Attention: The coordinates refer to the image above. Values in Lux.

Grid: 1 x 2 Points

E_{av} [lx]	E_{min} [lx]	E_{max} [lx]	u0	E_{min} / E_{max}
3.30	3.23	3.38	0.98	0.96

MIDSTREAM LIGHTING LIMITED
 WESSEX HOUSE
 1 CHESHAM STREET
 LONDON, SW 1X 8ND, UNITED KINGDOM

Operator MIDSTREAM LIGHTING LIMITED
 Telephone +44 (0)207 584 8310
 Fax
 e-Mail info@midstreamlighting.com

Half Pitch 1 / Spill Out - House 7 / Table (E, Perpendicular)



Position of surface in external scene:
 Marked point: (115.660 m, -20.479 m,
 0.000 m)



1.000 2.88

0.000 3.03

m **4.000**

Attention: The coordinates refer to the image above. Values in Lux.

Grid: 1 x 2 Points

E_{av} [lx]
2.96

E_{min} [lx]
2.88

E_{max} [lx]
3.03

u0
0.98

E_{min} / E_{max}
0.95

MIDSTREAM LIGHTING LIMITED
 WESSEX HOUSE
 1 CHESHAM STREET
 LONDON, SW 1X 8ND, UNITED KINGDOM

Operator MIDSTREAM LIGHTING LIMITED
 Telephone +44 (0)207 584 8310
 Fax
 e-Mail info@midstreamlighting.com

Half Pitch 1 / Spill Out - House 8 / Table (E, Perpendicular)



Position of surface in external scene:
 Marked point: (116.882 m, -32.699 m,
 0.000 m)



1.000 2.42

0.000 2.55

m **4.000**

Attention: The coordinates refer to the image above. Values in Lux.

Grid: 1 x 2 Points

E_{av} [lx]
2.48

E_{min} [lx]
2.42

E_{max} [lx]
2.55

u0
0.97

E_{min} / E_{max}
0.95

MIDSTREAM LIGHTING LIMITED
 WESSEX HOUSE
 1 CHESHAM STREET
 LONDON, SW 1X 8ND, UNITED KINGDOM

Operator MIDSTREAM LIGHTING LIMITED
 Telephone +44 (0)207 584 8310
 Fax
 e-Mail info@midstreamlighting.com

Half Pitch 1 / Spill Out - House 9 / Table (E, Perpendicular)



Position of surface in external scene:
 Marked point: (120.096 m, -43.937 m,
 0.000 m)



1.000 1.95

0.000 2.03

m 4.500

Attention: The coordinates refer to the image above. Values in Lux.

Grid: 1 x 2 Points

E_{av} [lx]	E_{min} [lx]	E_{max} [lx]	$u0$	E_{min} / E_{max}
1.99	1.95	2.03	0.98	0.96

MIDSTREAM LIGHTING LIMITED
 WESSEX HOUSE
 1 CHESHAM STREET
 LONDON, SW 1X 8ND, UNITED KINGDOM

Operator MIDSTREAM LIGHTING LIMITED
 Telephone +44 (0)207 584 8310
 Fax
 e-Mail info@midstreamlighting.com

Half Pitch 1 / Spill Out - House 10 / Table (E, Perpendicular)



Position of surface in external scene:
 Marked point: (122.381 m, -56.528 m,
 0.000 m)

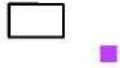

1.000 1.56

0.000 1.62

m 4.000

Attention: The coordinates refer to the image above. Values in Lux.

Grid: 1 x 2 Points

E_{av} [lx]
1.59

E_{min} [lx]
1.56

E_{max} [lx]
1.62

u_0
0.98

E_{min} / E_{max}
0.96

MIDSTREAM LIGHTING LIMITED
 WESSEX HOUSE
 1 CHESHAM STREET
 LONDON, SW 1X 8ND, UNITED KINGDOM

Operator MIDSTREAM LIGHTING LIMITED
 Telephone +44 (0)207 584 8310
 Fax
 e-Mail info@midstreamlighting.com

Half Pitch 1 / Spill Out - House 11 / Table (E, Perpendicular)



Position of surface in external scene:
 Marked point: (124.128 m, -67.767 m,
 0.000 m)



1.000 1.23

0.000 1.28

m 4.500

Attention: The coordinates refer to the image above. Values in Lux.

Grid: 1 x 2 Points

E_{av} [lx]	E_{min} [lx]	E_{max} [lx]	u0	E_{min} / E_{max}
1.25	1.23	1.28	0.98	0.96

MIDSTREAM LIGHTING LIMITED
 WESSEX HOUSE
 1 CHESHAM STREET
 LONDON, SW 1X 8ND, UNITED KINGDOM

Operator MIDSTREAM LIGHTING LIMITED
 Telephone +44 (0)207 584 8310
 Fax
 e-Mail info@midstreamlighting.com

Half Pitch 1 / Spill Out - House 12 / Table (E, Perpendicular)



Position of surface in external scene:
 Marked point: (127.356 m, -79.016 m,
 0.000 m)



1.000 1.00

0.000 1.04

m 3.500

Attention: The coordinates refer to the image above. Values in Lux.

Grid: 1 x 2 Points

E_{av} [lx]	E_{min} [lx]	E_{max} [lx]	u0	E_{min} / E_{max}
1.02	1.00	1.04	0.98	0.96

MIDSTREAM LIGHTING LIMITED
 WESSEX HOUSE
 1 CHESHAM STREET
 LONDON, SW 1X 8ND, UNITED KINGDOM

Operator MIDSTREAM LIGHTING LIMITED
 Telephone +44 (0)207 584 8310
 Fax
 e-Mail info@midstreamlighting.com

Half Pitch 1 / Spill Out - House 13 / Table (E, Perpendicular)



Position of surface in external scene:
 Marked point: (128.212 m, -88.548 m,
 0.000 m)



1.000 0.86

0.000 0.89

m 3.500

Attention: The coordinates refer to the image above. Values in Lux.

Grid: 1 x 2 Points

E_{av} [lx]	E_{min} [lx]	E_{max} [lx]	u0	E_{min} / E_{max}
0.87	0.86	0.89	0.98	0.96

MIDSTREAM LIGHTING LIMITED
 WESSEX HOUSE
 1 CHESHAM STREET
 LONDON, SW 1X 8ND, UNITED KINGDOM

Operator MIDSTREAM LIGHTING LIMITED
 Telephone +44 (0)207 584 8310
 Fax
 e-Mail info@midstreamlighting.com

Half Pitch 1 / Spill Out - House 14 / Table (E, Perpendicular)



Position of surface in external scene:
 Marked point: (129.958 m, -99.421 m,
 0.000 m)



1.000 0.72

0.000 0.74

m 4.000

Attention: The coordinates refer to the image above. Values in Lux.

Grid: 1 x 2 Points

E_{av} [lx]
0.73

E_{min} [lx]
0.72

E_{max} [lx]
0.74

u0
0.99

E_{min} / E_{max}
0.97

MIDSTREAM LIGHTING LIMITED
 WESSEX HOUSE
 1 CHESHAM STREET
 LONDON, SW 1X 8ND, UNITED KINGDOM

Operator MIDSTREAM LIGHTING LIMITED
 Telephone +44 (0)207 584 8310
 Fax
 e-Mail info@midstreamlighting.com

Half Pitch 1 / Spill Out - House 15 / Table (E, Perpendicular)



Position of surface in external scene:
 Marked point: (131.965 m, -
 109.204 m, 0.000 m)



1.000 0.63

0.000 0.65

m 3.000

Attention: The coordinates refer to the image above. Values in Lux.

Grid: 1 x 2 Points

E_{av} [lx]	E_{min} [lx]	E_{max} [lx]	$u0$	E_{min} / E_{max}
0.64	0.63	0.65	0.99	0.97

MIDSTREAM LIGHTING LIMITED
 WESSEX HOUSE
 1 CHESHAM STREET
 LONDON, SW 1X 8ND, UNITED KINGDOM

Operator MIDSTREAM LIGHTING LIMITED
 Telephone +44 (0)207 584 8310
 Fax
 e-Mail info@midstreamlighting.com

Half Pitch 1 / Spill Out - House 16 / Table (E, Perpendicular)



Position of surface in external scene:
 Marked point: (133.857 m, -
 122.247 m, 0.000 m)



1.000 0.55

0.000 0.57

m 9.500

Attention: The coordinates refer to the image above. Values in Lux.

Grid: 1 x 2 Points

E_{av} [lx]
0.56

E_{min} [lx]
0.55

E_{max} [lx]
0.57

u_0
0.99

E_{min} / E_{max}
0.97

MIDSTREAM LIGHTING LIMITED
 WESSEX HOUSE
 1 CHESHAM STREET
 LONDON, SW 1X 8ND, UNITED KINGDOM

Operator MIDSTREAM LIGHTING LIMITED
 Telephone +44 (0)207 584 8310
 Fax
 e-Mail info@midstreamlighting.com

Half Pitch 1 / Spill Out - House 18 / Table (E, Perpendicular)



Position of surface in external scene:
 Marked point: (127.153 m, -
 157.373 m, 1.000 m)



1.000 0.57

0.000 0.55

m 3.500

Attention: The coordinates refer to the image above. Values in Lux.

Grid: 1 x 2 Points

E_{av} [lx]	E_{min} [lx]	E_{max} [lx]	u0	E_{min} / E_{max}
0.56	0.55	0.57	0.98	0.97

MIDSTREAM LIGHTING LIMITED
 WESSEX HOUSE
 1 CHESHAM STREET
 LONDON, SW 1X 8ND, UNITED KINGDOM

Operator MIDSTREAM LIGHTING LIMITED
 Telephone +44 (0)207 584 8310
 Fax
 e-Mail info@midstreamlighting.com

Half Pitch 1 / Spill Out - House 19 / Table (E, Perpendicular)



Position of surface in external scene:
 Marked point: (118.099 m, -
 156.395 m, 1.000 m)



1.000 0.65

0.000 0.63

m 4.000

Attention: The coordinates refer to the image above. Values in Lux.

Grid: 1 x 2 Points

E_{av} [lx]
0.64

E_{min} [lx]
0.63

E_{max} [lx]
0.65

u0
0.98

E_{min} / E_{max}
0.97

MIDSTREAM LIGHTING LIMITED
 WESSEX HOUSE
 1 CHESHAM STREET
 LONDON, SW 1X 8ND, UNITED KINGDOM

Operator MIDSTREAM LIGHTING LIMITED
 Telephone +44 (0)207 584 8310
 Fax
 e-Mail info@midstreamlighting.com

Half Pitch 1 / Spill Out - House 20 / Table (E, Perpendicular)



Position of surface in external scene:
 Marked point: (107.345 m, -
 155.662 m, 1.000 m)



1.000 0.76

0.000 0.73

m 4.000

Attention: The coordinates refer to the image above. Values in Lux.

Grid: 1 x 2 Points

E_{av} [lx]
0.75

E_{min} [lx]
0.73

E_{max} [lx]
0.76

u0
0.98

E_{min} / E_{max}
0.97

MIDSTREAM LIGHTING LIMITED
 WESSEX HOUSE
 1 CHESHAM STREET
 LONDON, SW 1X 8ND, UNITED KINGDOM

Operator MIDSTREAM LIGHTING LIMITED
 Telephone +44 (0)207 584 8310
 Fax
 e-Mail info@midstreamlighting.com

Half Pitch 1 / Spill Out - House 21 / Table (E, Perpendicular)



Position of surface in external scene:
 Marked point: (96.469 m, -155.051 m,
 1.000 m)



1.000 0.90

0.000 0.86

m 4.000

Attention: The coordinates refer to the image above. Values in Lux.

Grid: 1 x 2 Points

E_{av} [lx]	E_{min} [lx]	E_{max} [lx]	u0	E_{min} / E_{max}
0.88	0.86	0.90	0.98	0.96

MIDSTREAM LIGHTING LIMITED
 WESSEX HOUSE
 1 CHESHAM STREET
 LONDON, SW 1X 8ND, UNITED KINGDOM

Operator MIDSTREAM LIGHTING LIMITED
 Telephone +44 (0)207 584 8310
 Fax
 e-Mail info@midstreamlighting.com

Half Pitch 1 / Spill Out - House 22 / Table (E, Perpendicular)



Position of surface in external scene:
 Marked point: (84.104 m, -154.073 m,
 1.000 m)



1.000 1.08

0.000 1.04

m **5.000**

Attention: The coordinates refer to the image above. Values in Lux.

Grid: 1 x 2 Points

E_{av} [lx]	E_{min} [lx]	E_{max} [lx]	$u0$	E_{min} / E_{max}
1.06	1.04	1.08	0.98	0.96

MIDSTREAM LIGHTING LIMITED
 WESSEX HOUSE
 1 CHESHAM STREET
 LONDON, SW 1X 8ND, UNITED KINGDOM

Operator MIDSTREAM LIGHTING LIMITED
 Telephone +44 (0)207 584 8310
 Fax
 e-Mail info@midstreamlighting.com

Half Pitch 1 / Spill Out - House 23 / Table (E, Perpendicular)



Position of surface in external scene:
 Marked point: (73.995 m, -152.851 m,
 1.000 m)



1.000 1.32

0.000 1.27

m 3.500

Attention: The coordinates refer to the image above. Values in Lux.

Grid: 1 x 2 Points

E_{av} [lx]	E_{min} [lx]	E_{max} [lx]	u0	E_{min} / E_{max}
1.29	1.27	1.32	0.98	0.96

MIDSTREAM LIGHTING LIMITED
 WESSEX HOUSE
 1 CHESHAM STREET
 LONDON, SW 1X 8ND, UNITED KINGDOM

Operator MIDSTREAM LIGHTING LIMITED
 Telephone +44 (0)207 584 8310
 Fax
 e-Mail info@midstreamlighting.com

Half Pitch 1 / Spill Out - House 24 / Table (E, Perpendicular)



Position of surface in external scene:
 Marked point: (64.097 m, -152.118 m,
 1.000 m)



1.000 1.51

0.000 1.45

m 3.500

Attention: The coordinates refer to the image above. Values in Lux.

Grid: 1 x 2 Points

E_{av} [lx]	E_{min} [lx]	E_{max} [lx]	u0	E_{min} / E_{max}
1.48	1.45	1.51	0.98	0.96

MIDSTREAM LIGHTING LIMITED
 WESSEX HOUSE
 1 CHESHAM STREET
 LONDON, SW 1X 8ND, UNITED KINGDOM

Operator MIDSTREAM LIGHTING LIMITED
 Telephone +44 (0)207 584 8310
 Fax
 e-Mail info@midstreamlighting.com

Half Pitch 1 / Spill Out - House 25 / Table (E, Perpendicular)



Position of surface in external scene:
 Marked point: (50.621 m, -151.141 m,
 1.000 m)



1.000 1.79

0.000 1.71

m 5.000

Attention: The coordinates refer to the image above. Values in Lux.

Grid: 1 x 2 Points

E_{av} [lx]	E_{min} [lx]	E_{max} [lx]	$u0$	E_{min} / E_{max}
1.75	1.71	1.79	0.98	0.96

MIDSTREAM LIGHTING LIMITED
 WESSEX HOUSE
 1 CHESHAM STREET
 LONDON, SW 1X 8ND, UNITED KINGDOM

Operator MIDSTREAM LIGHTING LIMITED
 Telephone +44 (0)207 584 8310
 Fax
 e-Mail info@midstreamlighting.com

Half Pitch 1 / Spill Out - House 26 / Table (E, Perpendicular)



Position of surface in external scene:
 Marked point: (38.401 m, -149.919 m,
 1.000 m)



1.000 2.08

0.000 1.99

m **5.000**

Attention: The coordinates refer to the image above. Values in Lux.

Grid: 1 x 2 Points

E_{av} [lx]	E_{min} [lx]	E_{max} [lx]	$u0$	E_{min} / E_{max}
2.04	1.99	2.08	0.98	0.96

MIDSTREAM LIGHTING LIMITED
 WESSEX HOUSE
 1 CHESHAM STREET
 LONDON, SW 1X 8ND, UNITED KINGDOM

Operator MIDSTREAM LIGHTING LIMITED
 Telephone +44 (0)207 584 8310
 Fax
 e-Mail info@midstreamlighting.com

Half Pitch 1 / Spill Out - House 27 / Table (E, Perpendicular)



Position of surface in external scene:
 Marked point: (24.714 m, -148.819 m,
 1.000 m)



1.000 2.40

0.000 2.30

m 5.000

Attention: The coordinates refer to the image above. Values in Lux.

Grid: 1 x 2 Points

E_{av} [lx]	E_{min} [lx]	E_{max} [lx]	$u0$	E_{min} / E_{max}
2.35	2.30	2.40	0.98	0.96

MIDSTREAM LIGHTING LIMITED
 WESSEX HOUSE
 1 CHESHAM STREET
 LONDON, SW 1X 8ND, UNITED KINGDOM

Operator MIDSTREAM LIGHTING LIMITED
 Telephone +44 (0)207 584 8310
 Fax
 e-Mail info@midstreamlighting.com

Half Pitch 1 / Spill Out - House 28 / Table (E, Perpendicular)



Position of surface in external scene:
 Marked point: (3.996 m, -147.274 m,
 1.000 m)



1.000 2.70

0.000 2.60

m **8.500**

Attention: The coordinates refer to the image above. Values in Lux.

Grid: 1 x 2 Points

E_{av} [lx]	E_{min} [lx]	E_{max} [lx]	$u0$	E_{min} / E_{max}
2.65	2.60	2.70	0.98	0.96

MIDSTREAM LIGHTING LIMITED
 WESSEX HOUSE
 1 CHESHAM STREET
 LONDON, SW 1X 8ND, UNITED KINGDOM

Operator MIDSTREAM LIGHTING LIMITED
 Telephone +44 (0)207 584 8310
 Fax
 e-Mail info@midstreamlighting.com

Half Pitch 1 / Spill Out - House 29 / Table (E, Perpendicular)



Position of surface in external scene:
 Marked point: (-9.729 m, -146.346 m,
 1.000 m)



1.000 3.14

0.000 3.01

m 4.500

Attention: The coordinates refer to the image above. Values in Lux.

Grid: 1 x 2 Points

E_{av} [lx]	E_{min} [lx]	E_{max} [lx]	$u0$	E_{min} / E_{max}
3.08	3.01	3.14	0.98	0.96

MIDSTREAM LIGHTING LIMITED
 WESSEX HOUSE
 1 CHESHAM STREET
 LONDON, SW 1X 8ND, UNITED KINGDOM

Operator MIDSTREAM LIGHTING LIMITED
 Telephone +44 (0)207 584 8310
 Fax
 e-Mail info@midstreamlighting.com

Half Pitch 1 / Spill Out - House 30 / Table (E, Perpendicular)



Position of surface in external scene:
 Marked point: (-19.295 m, -143.006 m,
 1.000 m)



1.000 3.27

0.000 3.11

m 3.500

Attention: The coordinates refer to the image above. Values in Lux.

Grid: 1 x 2 Points

E_{av} [lx]	E_{min} [lx]	E_{max} [lx]	u0	E_{min} / E_{max}
3.19	3.11	3.27	0.98	0.95

MIDSTREAM LIGHTING LIMITED
 WESSEX HOUSE
 1 CHESHAM STREET
 LONDON, SW 1X 8ND, UNITED KINGDOM

Operator MIDSTREAM LIGHTING LIMITED
 Telephone +44 (0)207 584 8310
 Fax
 e-Mail info@midstreamlighting.com

Half Pitch 1 / Spill Out - House 31 / Table (E, Perpendicular)



Position of surface in external scene:
 Marked point: (-25.649 m, -138.418 m,
 1.000 m)



1.000 3.20

0.000 3.02

m 3.500

Attention: The coordinates refer to the image above. Values in Lux.

Grid: 1 x 2 Points

E_{av} [lx]	E_{min} [lx]	E_{max} [lx]	u0	E_{min} / E_{max}
3.11	3.02	3.20	0.97	0.95

MIDSTREAM LIGHTING LIMITED
 WESSEX HOUSE
 1 CHESHAM STREET
 LONDON, SW 1X 8ND, UNITED KINGDOM

Operator MIDSTREAM LIGHTING LIMITED
 Telephone +44 (0)207 584 8310
 Fax
 e-Mail info@midstreamlighting.com

Half Pitch 1 / Spill Out - House 32 / Table (E, Perpendicular)



Position of surface in external scene:
 Marked point: (-32.537 m, -132.752 m,
 1.000 m)



1.000 3.73

0.000 3.51

m 3.500

Attention: The coordinates refer to the image above. Values in Lux.

Grid: 1 x 2 Points

E_{av} [lx]
3.62

E_{min} [lx]
3.51

E_{max} [lx]
3.73

u0
0.97

E_{min} / E_{max}
0.94

MIDSTREAM LIGHTING LIMITED
 WESSEX HOUSE
 1 CHESHAM STREET
 LONDON, SW 1X 8ND, UNITED KINGDOM

Operator MIDSTREAM LIGHTING LIMITED
 Telephone +44 (0)207 584 8310
 Fax
 e-Mail info@midstreamlighting.com

Half Pitch 1 / Spill Out - House 33 / Table (E, Perpendicular)



Position of surface in external scene:
 Marked point: (-36.002 m, -118.095 m,
 1.000 m)



1.000 0.62

0.000 0.59

m 5.000

Attention: The coordinates refer to the image above. Values in Lux.

Grid: 1 x 2 Points

E_{av} [lx]
0.61

E_{min} [lx]
0.59

E_{max} [lx]
0.62

$u0$
0.98

E_{min} / E_{max}
0.96

MIDSTREAM LIGHTING LIMITED
 WESSEX HOUSE
 1 CHESHAM STREET
 LONDON, SW 1X 8ND, UNITED KINGDOM

Operator MIDSTREAM LIGHTING LIMITED
 Telephone +44 (0)207 584 8310
 Fax
 e-Mail info@midstreamlighting.com

Half Pitch 1 / Spill Out - House 34 / Table (E, Perpendicular)



Position of surface in external scene:
 Marked point: (-38.113 m, -98.543 m,
 1.000 m)



1.000 1.08

0.000 1.05

m **5.000**

Attention: The coordinates refer to the image above. Values in Lux.

Grid: 1 x 2 Points

E_{av} [lx]	E_{min} [lx]	E_{max} [lx]	$u0$	E_{min} / E_{max}
1.06	1.05	1.08	0.98	0.97

MIDSTREAM LIGHTING LIMITED
 WESSEX HOUSE
 1 CHESHAM STREET
 LONDON, SW 1X 8ND, UNITED KINGDOM

Operator MIDSTREAM LIGHTING LIMITED
 Telephone +44 (0)207 584 8310
 Fax
 e-Mail info@midstreamlighting.com

Half Pitch 1 / Spill Out - House 35 / Table (E, Perpendicular)



Position of surface in external scene:
 Marked point: (-43.779 m, -72.992 m,
 1.000 m)



1.000 2.94

0.000 2.81

m **5.000**

Attention: The coordinates refer to the image above. Values in Lux.

Grid: 1 x 2 Points

E_{av} [lx]	E_{min} [lx]	E_{max} [lx]	$u0$	E_{min} / E_{max}
2.87	2.81	2.94	0.98	0.96

MIDSTREAM LIGHTING LIMITED
 WESSEX HOUSE
 1 CHESHAM STREET
 LONDON, SW 1X 8ND, UNITED KINGDOM

Operator MIDSTREAM LIGHTING LIMITED
 Telephone +44 (0)207 584 8310
 Fax
 e-Mail info@midstreamlighting.com

Half Pitch 1 / Spill Out - House 37 / Table (E, Perpendicular)



Position of surface in external scene:
 Marked point: (-61.264 m, -29.524 m,
 1.000 m)



1.000 47
 0.000 46
 m 5.000

Attention: The coordinates refer to the image above. Values in Lux.

Grid: 1 x 2 Points

E_{av} [lx]	E_{min} [lx]	E_{max} [lx]	$u0$	E_{min} / E_{max}
46	46	47	0.99	0.98

MIDSTREAM LIGHTING LIMITED
 WESSEX HOUSE
 1 CHESHAM STREET
 LONDON, SW 1X 8ND, UNITED KINGDOM

Operator MIDSTREAM LIGHTING LIMITED
 Telephone +44 (0)207 584 8310
 Fax
 e-Mail info@midstreamlighting.com

Half Pitch 1 / Spill Out - House 38 / Table (E, Perpendicular)



Position of surface in external scene:
 Marked point: (-71.091 m, -9.441 m,
 1.000 m)



1.000 39

0.000 38

m 4.500

Attention: The coordinates refer to the image above. Values in Lux.

Grid: 1 x 2 Points

E_{av} [lx]	E_{min} [lx]	E_{max} [lx]	$u0$	E_{min} / E_{max}
38	38	39	0.99	0.98

MIDSTREAM LIGHTING LIMITED
 WESSEX HOUSE
 1 CHESHAM STREET
 LONDON, SW 1X 8ND, UNITED KINGDOM

Operator MIDSTREAM LIGHTING LIMITED
 Telephone +44 (0)207 584 8310
 Fax
 e-Mail info@midstreamlighting.com

Half Pitch 1 / Spill Out - House 39 / Table (E, Perpendicular)



Position of surface in external scene:
 Marked point: (-78.714 m, 3.522 m,
 1.000 m)



1.000 25

0.000 24

m 6.000

Attention: The coordinates refer to the image above. Values in Lux.

Grid: 1 x 2 Points

E_{av} [lx]	E_{min} [lx]	E_{max} [lx]	u0	E_{min} / E_{max}
24	24	25	0.98	0.97

MIDSTREAM LIGHTING LIMITED
 WESSEX HOUSE
 1 CHESHAM STREET
 LONDON, SW 1X 8ND, UNITED KINGDOM

Operator MIDSTREAM LIGHTING LIMITED
 Telephone +44 (0)207 584 8310
 Fax
 e-Mail info@midstreamlighting.com

Half Pitch 1 / Spill Out - House 40 / Table (E, Perpendicular)



Position of surface in external scene:
 Marked point: (-88.370 m, 17.246 m,
 1.000 m)



1.000 12
 0.000 12
 m 5.000

Attention: The coordinates refer to the image above. Values in Lux.

Grid: 1 x 2 Points

E_{av} [lx]	E_{min} [lx]	E_{max} [lx]	$u0$	E_{min} / E_{max}
12	12	12	0.99	0.98

MIDSTREAM LIGHTING LIMITED
 WESSEX HOUSE
 1 CHESHAM STREET
 LONDON, SW 1X 8ND, UNITED KINGDOM

Operator MIDSTREAM LIGHTING LIMITED
 Telephone +44 (0)207 584 8310
 Fax
 e-Mail info@midstreamlighting.com

Half Pitch 1 / Spill Out - House 41 / Table (E, Perpendicular)



Position of surface in external scene:
 Marked point: (-93.814 m, 31.466 m,
 1.000 m)



1.000 7.27

0.000 7.11

m 5.000

Attention: The coordinates refer to the image above. Values in Lux.

Grid: 1 x 2 Points

E_{av} [lx]	E_{min} [lx]	E_{max} [lx]	$u0$	E_{min} / E_{max}
7.19	7.11	7.27	0.99	0.98

MIDSTREAM LIGHTING LIMITED
 WESSEX HOUSE
 1 CHESHAM STREET
 LONDON, SW 1X 8ND, UNITED KINGDOM

Operator MIDSTREAM LIGHTING LIMITED
 Telephone +44 (0)207 584 8310
 Fax
 e-Mail info@midstreamlighting.com

Half Pitch 1 / Spill Out - House 42 / Table (E, Perpendicular)



Position of surface in external scene:
 Marked point: (-98.702 m, 43.908 m,
 1.000 m)



1.000 4.02
0.000 3.92
m **5.000**

Attention: The coordinates refer to the image above. Values in Lux.

Grid: 1 x 2 Points

E_{av} [lx]	E_{min} [lx]	E_{max} [lx]	$u0$	E_{min} / E_{max}
3.97	3.92	4.02	0.99	0.98

MIDSTREAM LIGHTING LIMITED
 WESSEX HOUSE
 1 CHESHAM STREET
 LONDON, SW 1X 8ND, UNITED KINGDOM

Operator MIDSTREAM LIGHTING LIMITED
 Telephone +44 (0)207 584 8310
 Fax
 e-Mail info@midstreamlighting.com

Half Pitch 1 / Spill Out - House 43 / Table (E, Perpendicular)



Position of surface in external scene:
 Marked point: (-101.368 m, 54.906 m,
 1.000 m)



1.000 2.70

0.000 2.63

m 5.000

Attention: The coordinates refer to the image above. Values in Lux.

Grid: 1 x 2 Points

E_{av} [lx]	E_{min} [lx]	E_{max} [lx]	$u0$	E_{min} / E_{max}
2.66	2.63	2.70	0.99	0.98

MIDSTREAM LIGHTING LIMITED
 WESSEX HOUSE
 1 CHESHAM STREET
 LONDON, SW 1X 8ND, UNITED KINGDOM

Operator MIDSTREAM LIGHTING LIMITED
 Telephone +44 (0)207 584 8310
 Fax
 e-Mail info@midstreamlighting.com

Half Pitch 2 / Planning data

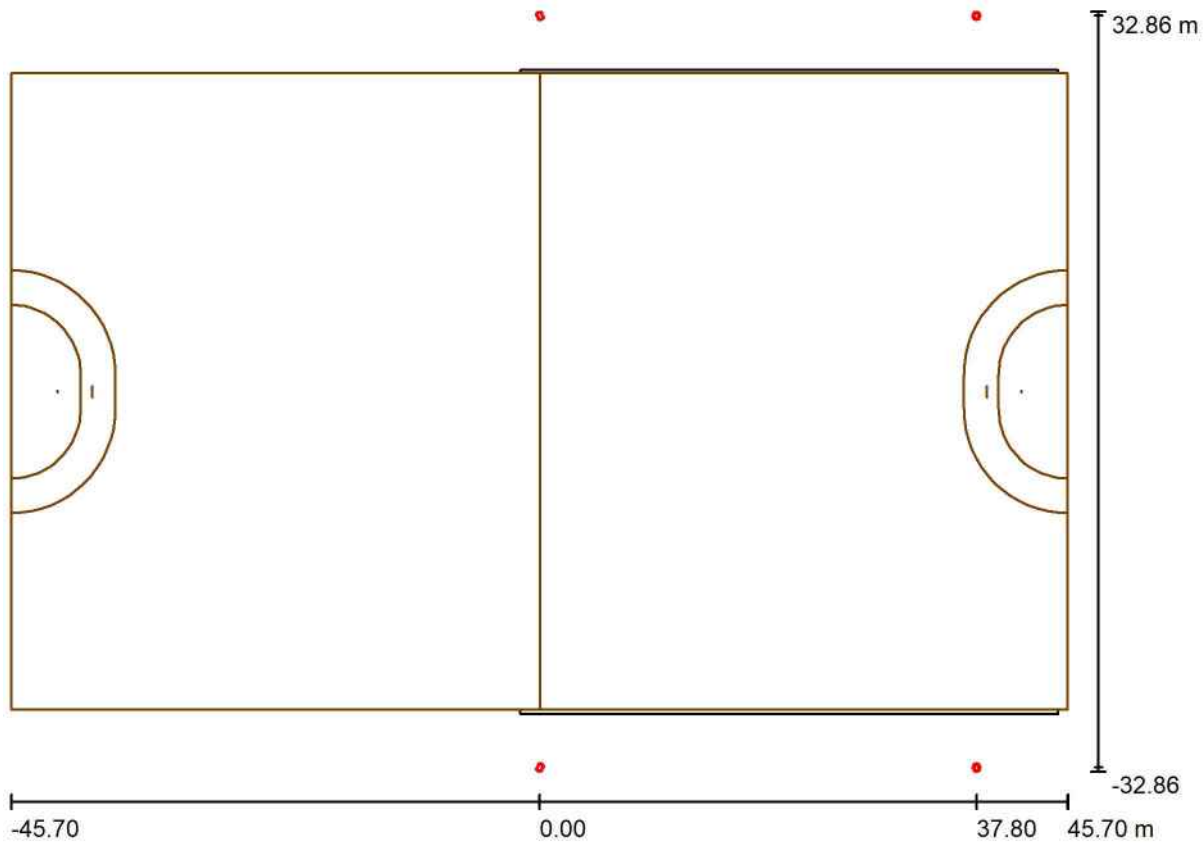

Light loss factor: 0.90, ULR (Upward Light Ratio): 0.5%

Scale 1:654

Luminaire Parts List

No.	Pieces	Designation (Correction Factor)	Φ (Luminaire) [lm]	Φ (Lamps) [lm]	P [W]
1	10	MIDSTREAM - Modus S1500 NS (5000K) (1.000)	172248	172245	1500.0
2	2	MIDSTREAM - Modus S1500 WS (5000K) (1.000)	172247	172246	1500.0
Total:			2066973	Total: 2066942	18000.0

MIDSTREAM LIGHTING LIMITED
WESSEX HOUSE
1 CHESHAM STREET
LONDON, SW 1X 8ND, UNITED KINGDOM

Operator MIDSTREAM LIGHTING LIMITED
Telephone +44 (0)207 584 8310
Fax
e-Mail info@midstreamlighting.com

Half Pitch 2 / Luminaire parts list

10 Pieces MIDSTREAM - Modus S1500 NS (5000K)
Article No.:
Luminous flux (Luminaire): 172248 lm
Luminous flux (Lamps): 172245 lm
Luminaire Wattage: 1500.0 W
Luminaire classification according to CIE: 100
CIE flux code: 24 67 95 100 100
Fitting: 1 x LED (Correction Factor 1.000).

See our luminaire catalog
for an image of the
luminaire.

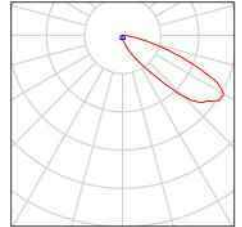

2 Pieces MIDSTREAM - Modus S1500 WS (5000K)
Article No.:
Luminous flux (Luminaire): 172247 lm
Luminous flux (Lamps): 172246 lm
Luminaire Wattage: 1500.0 W
Luminaire classification according to CIE: 100
CIE flux code: 31 67 95 100 100
Fitting: 1 x LED (Correction Factor 1.000).

See our luminaire catalog
for an image of the
luminaire.

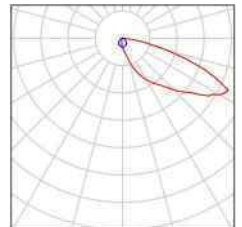

MIDSTREAM LIGHTING LIMITED
 WESSEX HOUSE
 1 CHESHAM STREET
 LONDON, SW 1X 8ND, UNITED KINGDOM

Operator MIDSTREAM LIGHTING LIMITED
 Telephone +44 (0)207 584 8310
 Fax
 e-Mail info@midstreamlighting.com

Half Pitch 2 / Luminaires (layout plan)

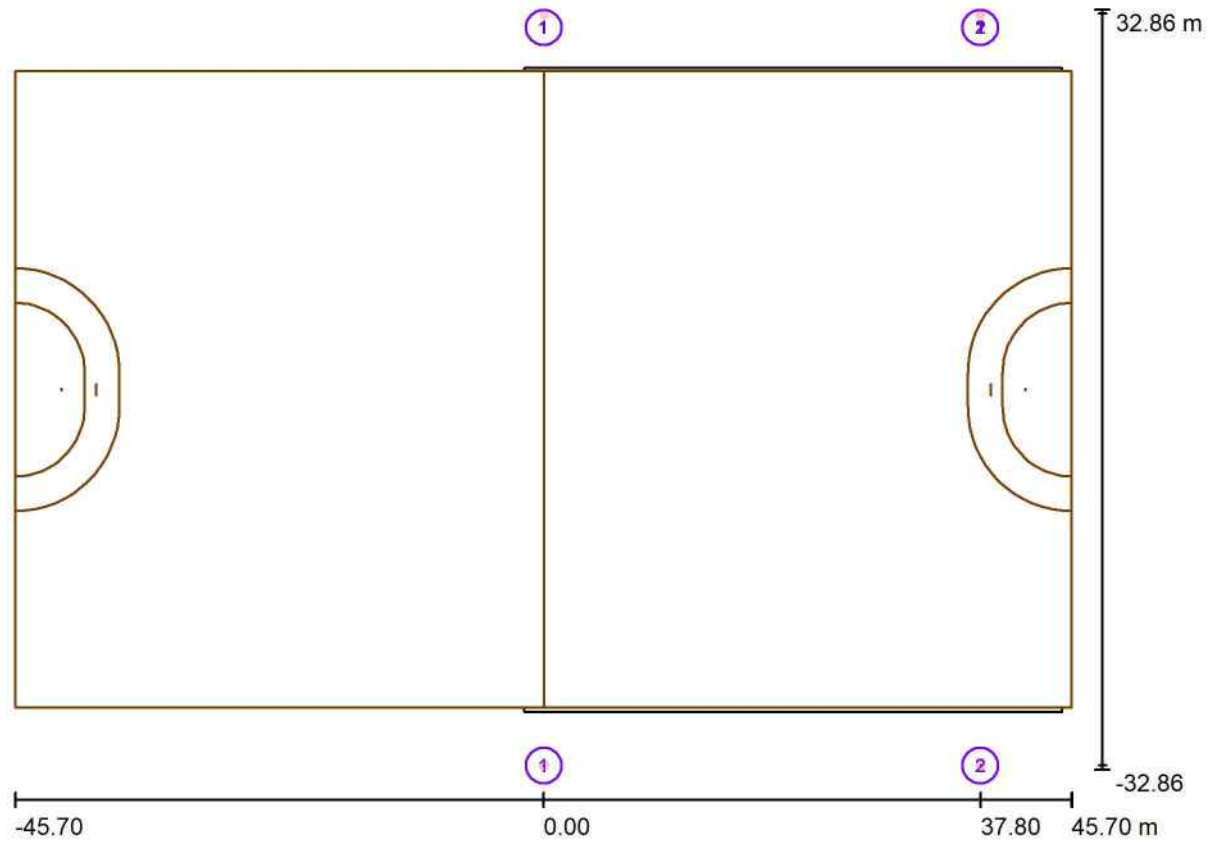

Scale 1 : 654

Luminaire Parts List

No.	Pieces	Designation
1	10	MIDSTREAM - Modus S1500 NS (5000K)
2	2	MIDSTREAM - Modus S1500 WS (5000K)

MIDSTREAM LIGHTING LIMITED
 WESSEX HOUSE
 1 CHESHAM STREET
 LONDON, SW 1X 8ND, UNITED KINGDOM

Operator MIDSTREAM LIGHTING LIMITED
 Telephone +44 (0)207 584 8310
 Fax
 e-Mail info@midstreamlighting.com

Half Pitch 2 / Luminaires (coordinates list)

MIDSTREAM - Modus S1500 NS (5000K)

172248 lm, 1500.0 W, 1 x 1 x LED (Correction Factor 1.000).

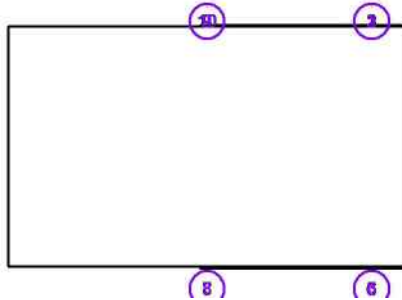

No.	Position [m]			Rotation [°]		
	X	Y	Z	X	Y	Z
1	37.800	32.500	16.000	0.0	-4.2	-87.2
2	37.800	32.500	16.000	0.0	-6.5	-116.8
3	37.800	32.500	16.000	0.0	-5.1	-156.5
4	37.800	-32.500	16.000	0.0	-4.2	87.2
5	37.800	-32.500	16.000	0.0	-6.5	116.8
6	37.800	-32.500	16.000	0.0	-5.1	156.5
7	0.000	-32.500	16.000	0.0	-5.6	55.0
8	0.000	-32.500	16.000	0.0	-5.4	79.6
9	0.000	32.500	16.000	0.0	-5.6	-55.0
10	0.000	32.500	16.000	0.0	-5.4	-79.6

MIDSTREAM LIGHTING LIMITED
 WESSEX HOUSE
 1 CHESHAM STREET
 LONDON, SW 1X 8ND, UNITED KINGDOM

Operator MIDSTREAM LIGHTING LIMITED
 Telephone +44 (0)207 584 8310
 Fax
 e-Mail info@midstreamlighting.com

Half Pitch 2 / Luminaires (coordinates list)

MIDSTREAM - Modus S1500 WS (5000K)
 172247 lm, 1500.0 W, 1 x 1 x LED (Correction Factor 1.000).



No.	Position [m]			Rotation [°]		
	X	Y	Z	X	Y	Z
1	37.800	32.500	16.000	0.0	1.5	-81.7
2	37.800	-32.500	16.000	0.0	1.5	81.7

MIDSTREAM LIGHTING LIMITED
 WESSEX HOUSE
 1 CHESHAM STREET
 LONDON, SW 1X 8ND, UNITED KINGDOM

Operator MIDSTREAM LIGHTING LIMITED
 Telephone +44 (0)207 584 8310
 Fax
 e-Mail info@midstreamlighting.com

Half Pitch 2 / GR Observer (Results Overview)

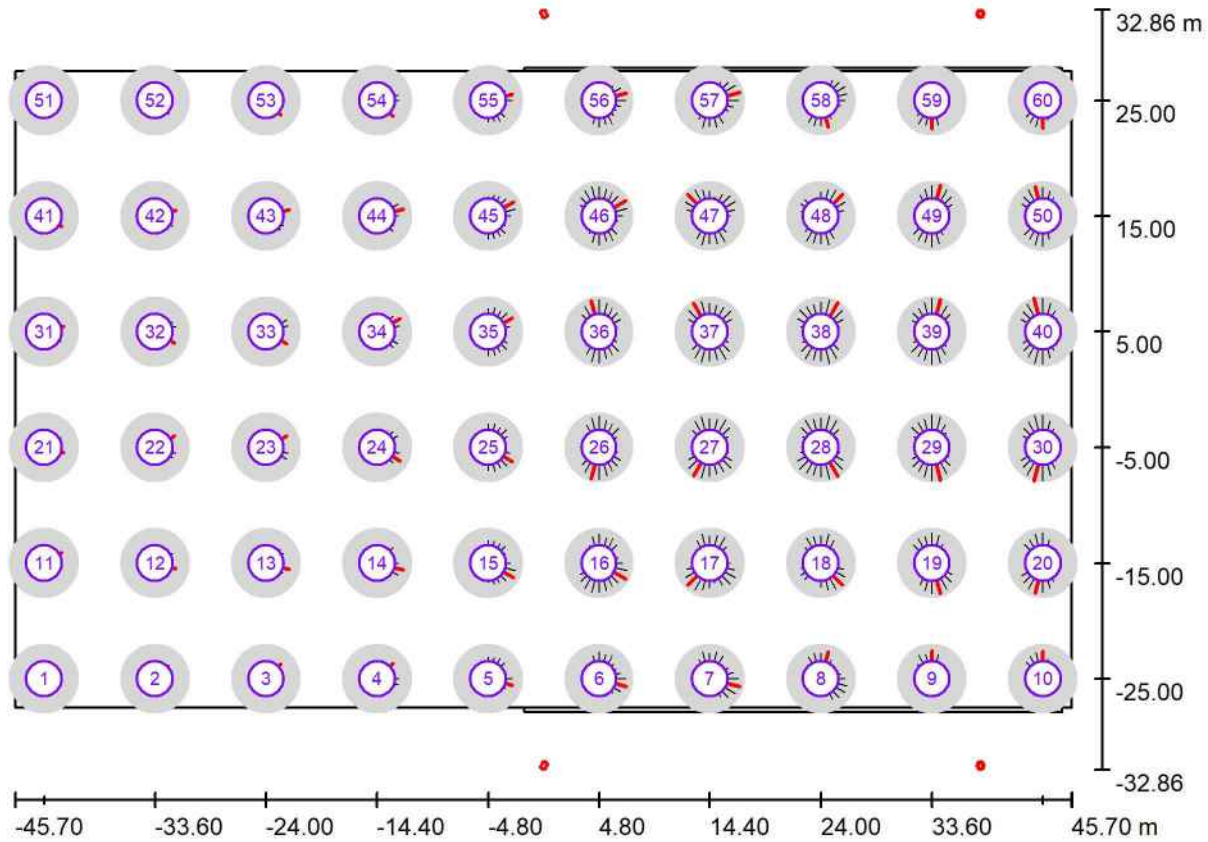

Scale 1 : 654

GR Observerlist

No.	Designation	Position [m]			Viewing sector [°]			Slope angle	Max
		X	Y	Z	Start	End	Increment		
1	GR Observer 1	-43.200	-25.000	1.500	0.0	360.0	15.0	-2.0	23 ²⁾
2	GR Observer 2	-33.600	-25.000	1.500	0.0	360.0	15.0	-2.0	24 ²⁾
3	GR Observer 3	-24.000	-25.000	1.500	0.0	360.0	15.0	-2.0	27 ²⁾
4	GR Observer 4	-14.400	-25.000	1.500	0.0	360.0	15.0	-2.0	29 ²⁾

MIDSTREAM LIGHTING LIMITED
 WESSEX HOUSE
 1 CHESHAM STREET
 LONDON, SW 1X 8ND, UNITED KINGDOM

Operator MIDSTREAM LIGHTING LIMITED
 Telephone +44 (0)207 584 8310
 Fax
 e-Mail info@midstreamlighting.com

Half Pitch 2 / GR Observer (Results Overview)

GR Observerlist

No.	Designation	Position [m]			Viewing sector [°]				Max
		X	Y	Z	Start	End	Increment	Slope angle	
5	GR Observer 5	-4.800	-25.000	1.500	0.0	360.0	15.0	-2.0	33 ²⁾
6	GR Observer 6	4.800	-25.000	1.500	0.0	360.0	15.0	-2.0	38 ²⁾
7	GR Observer 7	14.400	-25.000	1.500	0.0	360.0	15.0	-2.0	41 ²⁾
8	GR Observer 8	24.000	-25.000	1.500	0.0	360.0	15.0	-2.0	37 ²⁾
9	GR Observer 9	33.600	-25.000	1.500	0.0	360.0	15.0	-2.0	38 ²⁾
10	GR Observer 10	43.200	-25.000	1.500	0.0	360.0	15.0	-2.0	37 ²⁾
11	GR Observer 11	-43.200	-15.000	1.500	0.0	360.0	15.0	-2.0	27 ²⁾
12	GR Observer 12	-33.600	-15.000	1.500	0.0	360.0	15.0	-2.0	28 ²⁾
13	GR Observer 13	-24.000	-15.000	1.500	0.0	360.0	15.0	-2.0	32 ²⁾
14	GR Observer 14	-14.400	-15.000	1.500	0.0	360.0	15.0	-2.0	35 ²⁾
15	GR Observer 15	-4.800	-15.000	1.500	0.0	360.0	15.0	-2.0	38 ²⁾
16	GR Observer 16	4.800	-15.000	1.500	0.0	360.0	15.0	-2.0	42 ²⁾
17	GR Observer 17	14.400	-15.000	1.500	0.0	360.0	15.0	-2.0	41 ²⁾
18	GR Observer 18	24.000	-15.000	1.500	0.0	360.0	15.0	-2.0	41 ²⁾
19	GR Observer 19	33.600	-15.000	1.500	0.0	360.0	15.0	-2.0	42 ²⁾
20	GR Observer 20	43.200	-15.000	1.500	0.0	360.0	15.0	-2.0	41 ²⁾
21	GR Observer 21	-43.200	-5.000	1.500	0.0	360.0	15.0	-2.0	27 ²⁾
22	GR Observer 22	-33.600	-5.000	1.500	0.0	360.0	15.0	-2.0	30 ²⁾
23	GR Observer 23	-24.000	-5.000	1.500	0.0	360.0	15.0	-2.0	31 ²⁾
24	GR Observer 24	-14.400	-5.000	1.500	0.0	360.0	15.0	-2.0	35 ²⁾
25	GR Observer 25	-4.800	-5.000	1.500	0.0	360.0	15.0	-2.0	37 ²⁾
26	GR Observer 26	4.800	-5.000	1.500	0.0	360.0	15.0	-2.0	43 ²⁾
27	GR Observer 27	14.400	-5.000	1.500	0.0	360.0	15.0	-2.0	44 ²⁾
28	GR Observer 28	24.000	-5.000	1.500	0.0	360.0	15.0	-2.0	45 ²⁾
29	GR Observer 29	33.600	-5.000	1.500	0.0	360.0	15.0	-2.0	45 ²⁾
30	GR Observer 30	43.200	-5.000	1.500	0.0	360.0	15.0	-2.0	46 ²⁾
31	GR Observer 31	-43.200	5.000	1.500	0.0	360.0	15.0	-2.0	27 ²⁾
32	GR Observer 32	-33.600	5.000	1.500	0.0	360.0	15.0	-2.0	30 ²⁾
33	GR Observer 33	-24.000	5.000	1.500	0.0	360.0	15.0	-2.0	31 ²⁾
34	GR Observer 34	-14.400	5.000	1.500	0.0	360.0	15.0	-2.0	35 ²⁾
35	GR Observer 35	-4.800	5.000	1.500	0.0	360.0	15.0	-2.0	37 ²⁾
36	GR Observer 36	4.800	5.000	1.500	0.0	360.0	15.0	-2.0	43 ²⁾
37	GR Observer 37	14.400	5.000	1.500	0.0	360.0	15.0	-2.0	44 ²⁾
38	GR Observer 38	24.000	5.000	1.500	0.0	360.0	15.0	-2.0	45 ²⁾
39	GR Observer 39	33.600	5.000	1.500	0.0	360.0	15.0	-2.0	45 ²⁾
40	GR Observer 40	43.200	5.000	1.500	0.0	360.0	15.0	-2.0	46 ²⁾

MIDSTREAM LIGHTING LIMITED
 WESSEX HOUSE
 1 CHESHAM STREET
 LONDON, SW 1X 8ND, UNITED KINGDOM

Operator MIDSTREAM LIGHTING LIMITED
 Telephone +44 (0)207 584 8310
 Fax
 e-Mail info@midstreamlighting.com

Half Pitch 2 / GR Observer (Results Overview)

GR Observerlist

No.	Designation	Position [m]			Start	Viewing sector [°]			Slope angle	Max
		X	Y	Z		End	Increment			
41	GR Observer 41	-43.200	15.000	1.500	0.0	360.0	15.0	-2.0	27 ²⁾	
42	GR Observer 42	-33.600	15.000	1.500	0.0	360.0	15.0	-2.0	28 ²⁾	
43	GR Observer 43	-24.000	15.000	1.500	0.0	360.0	15.0	-2.0	32 ²⁾	
44	GR Observer 44	-14.400	15.000	1.500	0.0	360.0	15.0	-2.0	35 ²⁾	
45	GR Observer 45	-4.800	15.000	1.500	0.0	360.0	15.0	-2.0	38 ²⁾	
46	GR Observer 46	4.800	15.000	1.500	0.0	360.0	15.0	-2.0	42 ²⁾	
47	GR Observer 47	14.400	15.000	1.500	0.0	360.0	15.0	-2.0	41 ²⁾	
48	GR Observer 48	24.000	15.000	1.500	0.0	360.0	15.0	-2.0	41 ²⁾	
49	GR Observer 49	33.600	15.000	1.500	0.0	360.0	15.0	-2.0	42 ²⁾	
50	GR Observer 50	43.200	15.000	1.500	0.0	360.0	15.0	-2.0	41 ²⁾	
51	GR Observer 51	-43.200	25.000	1.500	0.0	360.0	15.0	-2.0	23 ²⁾	
52	GR Observer 52	-33.600	25.000	1.500	0.0	360.0	15.0	-2.0	24 ²⁾	
53	GR Observer 53	-24.000	25.000	1.500	0.0	360.0	15.0	-2.0	27 ²⁾	
54	GR Observer 54	-14.400	25.000	1.500	0.0	360.0	15.0	-2.0	29 ²⁾	
55	GR Observer 55	-4.800	25.000	1.500	0.0	360.0	15.0	-2.0	33 ²⁾	
56	GR Observer 56	4.800	25.000	1.500	0.0	360.0	15.0	-2.0	38 ²⁾	
57	GR Observer 57	14.400	25.000	1.500	0.0	360.0	15.0	-2.0	41 ²⁾	
58	GR Observer 58	24.000	25.000	1.500	0.0	360.0	15.0	-2.0	37 ²⁾	
59	GR Observer 59	33.600	25.000	1.500	0.0	360.0	15.0	-2.0	38 ²⁾	
60	GR Observer 60	43.200	25.000	1.500	0.0	360.0	15.0	-2.0	37 ²⁾	

2) The calculated equivalent veil luminance of the environment is based on the assumption of a complete diffuse reflection behavior of the environment (acc. EN 12464-2).

MIDSTREAM LIGHTING LIMITED
WESSEX HOUSE
1 CHESHAM STREET
LONDON, SW 1X 8ND, UNITED KINGDOM

Operator MIDSTREAM LIGHTING LIMITED
Telephone +44 (0)207 584 8310
Fax
e-Mail info@midstreamlighting.com

Half Pitch 2 / 3D Rendering

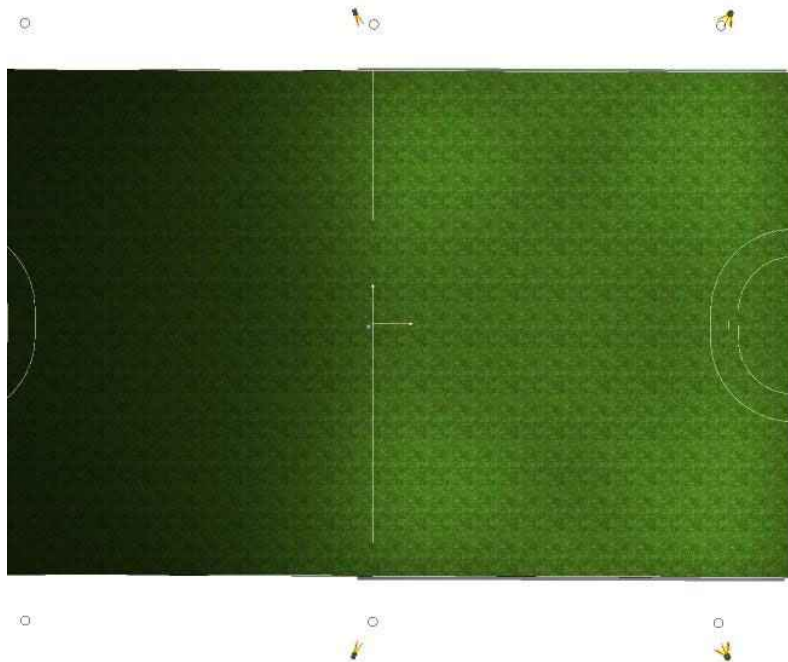

MIDSTREAM LIGHTING LIMITED
WESSEX HOUSE
1 CHESHAM STREET
LONDON, SW 1X 8ND, UNITED KINGDOM

Operator MIDSTREAM LIGHTING LIMITED
Telephone +44 (0)207 584 8310
Fax
e-Mail info@midstreamlighting.com

Half Pitch 2 / False Color Rendering

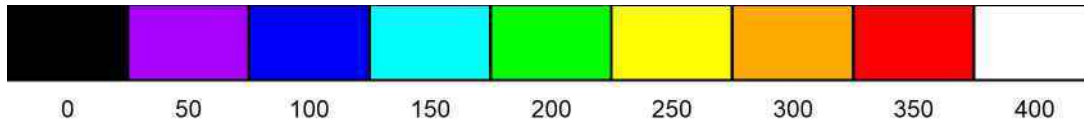
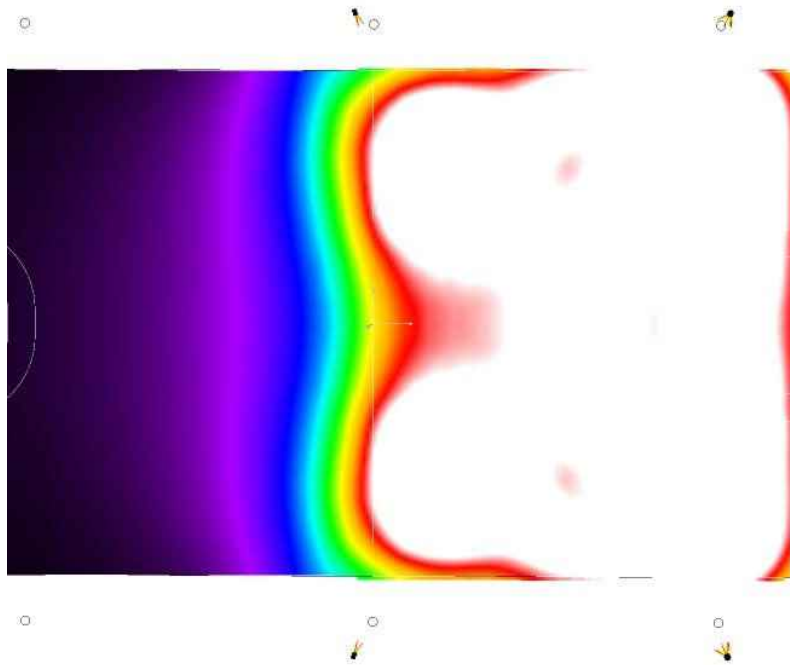

lx



MIDSTREAM LIGHTING LIMITED
 WESSEX HOUSE
 1 CHESHAM STREET
 LONDON, SW 1X 8ND, UNITED KINGDOM

Operator MIDSTREAM LIGHTING LIMITED
 Telephone +44 (0)207 584 8310
 Fax
 e-Mail info@midstreamlighting.com

Half Pitch 2 / Half Pitch 2 / Summary

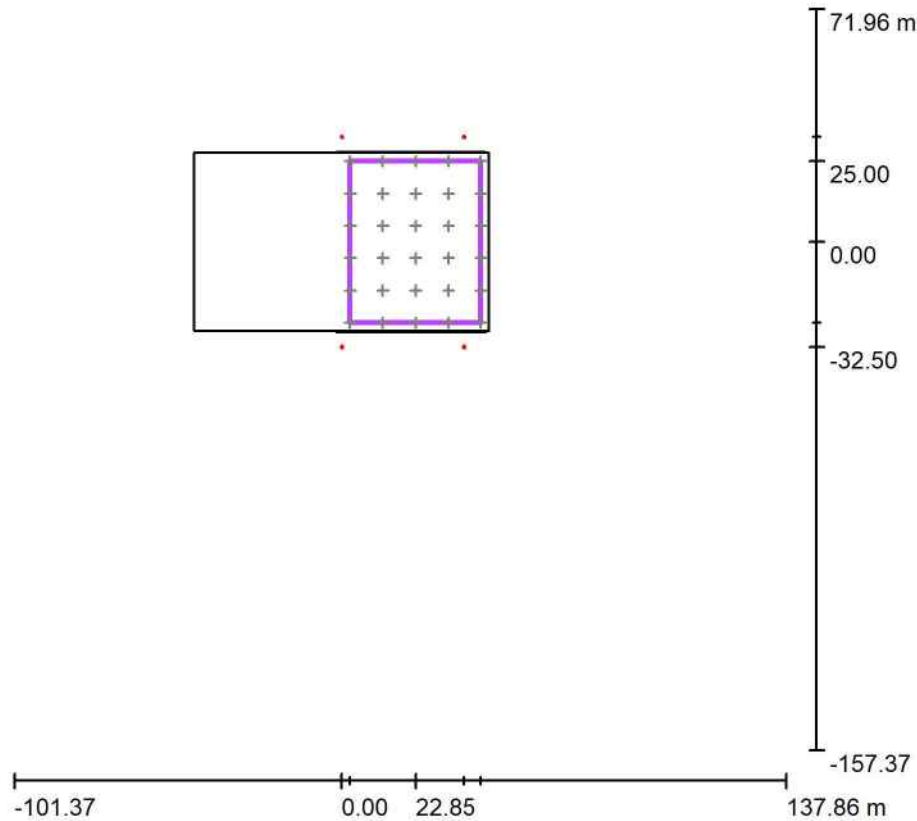

Scale 1 : 2343

Position: (22.850 m, 0.000 m, 0.000 m)
 Size: (40.700 m, 50.000 m)
 Rotation: (0.0°, 0.0°, 0.0°)
 Type: Normal, Grid: 5 x 6 Points

Results overview

No.	Type	E_{av} [lx]	E_{min} [lx]	E_{max} [lx]	$u0$	E_{min} / E_{max}	$E_{h,m} / E_m$	H [m]	Camera
1	horizontal	456	343	594	0.75	0.58	/	0.000	/

$E_{h,m} / E_m$ = Relationship between middle horizontal and vertical illuminance, H = Measuring Height

MIDSTREAM LIGHTING LIMITED
 WESSEX HOUSE
 1 CHESHAM STREET
 LONDON, SW 1X 8ND, UNITED KINGDOM

Operator MIDSTREAM LIGHTING LIMITED
 Telephone +44 (0)207 584 8310
 Fax
 e-Mail info@midstreamlighting.com

Half Pitch 2 / Half Pitch 2 / Value Chart (E, Horizontal)

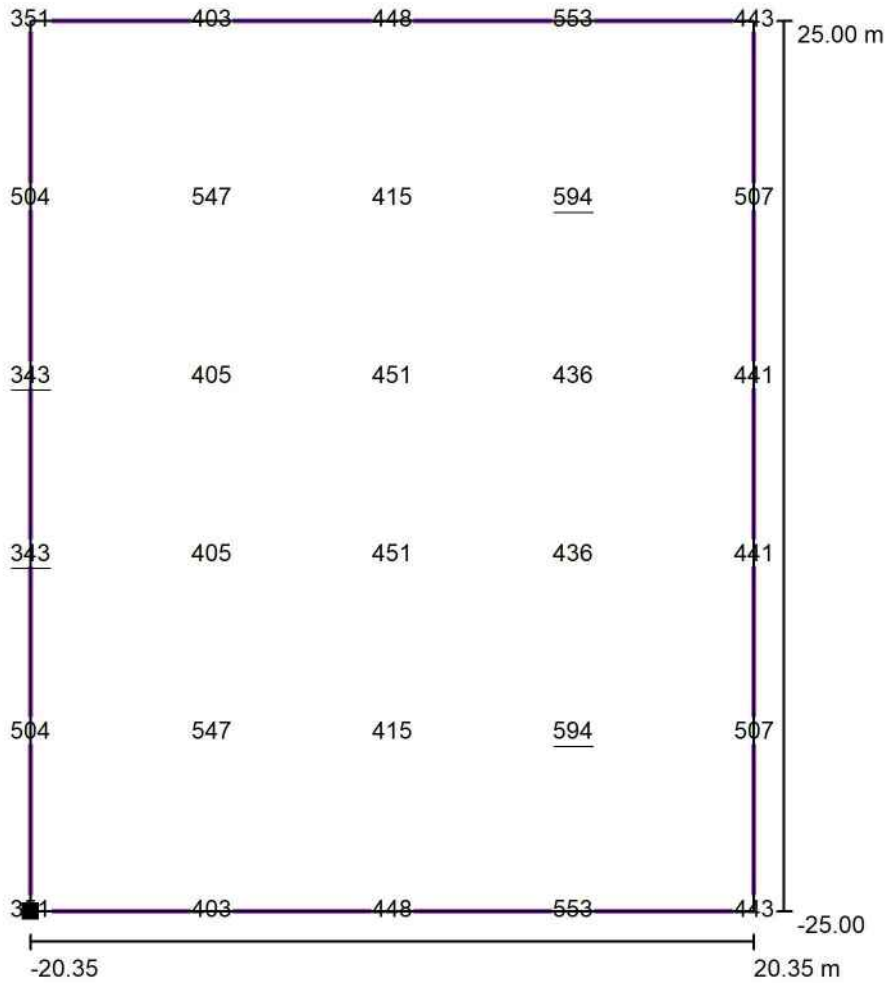

Values in Lux, Scale 1 : 425

Position of surface in external scene:
 Marked point: (2.500 m, -25.000 m,
 0.000 m)



Grid: 5 x 6 Points

E_{av} [lx]	E_{min} [lx]	E_{max} [lx]	u_0	E_{min} / E_{max}
456	343	594	0.75	0.58

MIDSTREAM LIGHTING LIMITED
 WESSEX HOUSE
 1 CHESHAM STREET
 LONDON, SW 1X 8ND, UNITED KINGDOM

Operator MIDSTREAM LIGHTING LIMITED
 Telephone +44 (0)207 584 8310
 Fax
 e-Mail info@midstreamlighting.com

Half Pitch 2 / Spill Out - House 1 / Table (E, Perpendicular)



Position of surface in external scene:
 Marked point: (105.514 m, 71.961 m,
 0.000 m)



1.000 2.78

0.000 2.86

m **5.000**

Attention: The coordinates refer to the image above. Values in Lux.

Grid: 1 x 2 Points

E_{av} [lx]	E_{min} [lx]	E_{max} [lx]	$u0$	E_{min} / E_{max}
2.82	2.78	2.86	0.98	0.97

MIDSTREAM LIGHTING LIMITED
 WESSEX HOUSE
 1 CHESHAM STREET
 LONDON, SW 1X 8ND, UNITED KINGDOM

Operator MIDSTREAM LIGHTING LIMITED
 Telephone +44 (0)207 584 8310
 Fax
 e-Mail info@midstreamlighting.com

Half Pitch 2 / Spill Out - House 2 / Table (E, Perpendicular)



Position of surface in external scene:
 Marked point: (109.320 m, 43.252 m,
 0.000 m)



1.000 3.74

0.000 3.85

m **5.000**

Attention: The coordinates refer to the image above. Values in Lux.

Grid: 1 x 2 Points

E_{av} [lx]	E_{min} [lx]	E_{max} [lx]	$u0$	E_{min} / E_{max}
3.79	3.74	3.85	0.99	0.97

MIDSTREAM LIGHTING LIMITED
 WESSEX HOUSE
 1 CHESHAM STREET
 LONDON, SW 1X 8ND, UNITED KINGDOM

Operator MIDSTREAM LIGHTING LIMITED
 Telephone +44 (0)207 584 8310
 Fax
 e-Mail info@midstreamlighting.com

Half Pitch 2 / Spill Out - House 3 / Table (E, Perpendicular)



Position of surface in external scene:
 Marked point: (111.607 m, 27.470 m,
 0.000 m)



1.000 4.23

0.000 4.35

m **4.000**

Attention: The coordinates refer to the image above. Values in Lux.

Grid: 1 x 2 Points

E_{av} [lx]
4.29

E_{min} [lx]
4.23

E_{max} [lx]
4.35

u0
0.99

E_{min} / E_{max}
0.97

MIDSTREAM LIGHTING LIMITED
 WESSEX HOUSE
 1 CHESHAM STREET
 LONDON, SW 1X 8ND, UNITED KINGDOM

Operator MIDSTREAM LIGHTING LIMITED
 Telephone +44 (0)207 584 8310
 Fax
 e-Mail info@midstreamlighting.com

Half Pitch 2 / Spill Out - House 4 / Table (E, Perpendicular)



Position of surface in external scene:
 Marked point: (112.554 m, 17.411 m,
 0.000 m)



1.000 4.39

0.000 4.50

m **5.000**

Attention: The coordinates refer to the image above. Values in Lux.

Grid: 1 x 2 Points

E_{av} [lx]	E_{min} [lx]	E_{max} [lx]	$u0$	E_{min} / E_{max}
4.44	4.39	4.50	0.99	0.98

MIDSTREAM LIGHTING LIMITED
 WESSEX HOUSE
 1 CHESHAM STREET
 LONDON, SW 1X 8ND, UNITED KINGDOM

Operator MIDSTREAM LIGHTING LIMITED
 Telephone +44 (0)207 584 8310
 Fax
 e-Mail info@midstreamlighting.com

Half Pitch 2 / Spill Out - House 5 / Table (E, Perpendicular)



Position of surface in external scene:
 Marked point: (112.921 m, 4.824 m,
 0.000 m)



1.000 4.43

0.000 4.55

m 5.000

Attention: The coordinates refer to the image above. Values in Lux.

Grid: 1 x 2 Points

E_{av} [lx]	E_{min} [lx]	E_{max} [lx]	$u0$	E_{min} / E_{max}
4.49	4.43	4.55	0.99	0.97

MIDSTREAM LIGHTING LIMITED
 WESSEX HOUSE
 1 CHESHAM STREET
 LONDON, SW 1X 8ND, UNITED KINGDOM

Operator MIDSTREAM LIGHTING LIMITED
 Telephone +44 (0)207 584 8310
 Fax
 e-Mail info@midstreamlighting.com

Half Pitch 2 / Spill Out - House 6 / Table (E, Perpendicular)



Position of surface in external scene:
 Marked point: (114.805 m, -9.359 m,
 0.000 m)



1.000 3.84

0.000 3.94

m **4.000**

Attention: The coordinates refer to the image above. Values in Lux.

Grid: 1 x 2 Points

E_{av} [lx]
3.89

E_{min} [lx]
3.84

E_{max} [lx]
3.94

u0
0.99

E_{min} / E_{max}
0.98

MIDSTREAM LIGHTING LIMITED
 WESSEX HOUSE
 1 CHESHAM STREET
 LONDON, SW 1X 8ND, UNITED KINGDOM

Operator MIDSTREAM LIGHTING LIMITED
 Telephone +44 (0)207 584 8310
 Fax
 e-Mail info@midstreamlighting.com

Half Pitch 2 / Spill Out - House 7 / Table (E, Perpendicular)



Position of surface in external scene:
 Marked point: (115.660 m, -20.479 m,
 0.000 m)



1.000 3.27

0.000 3.34

m 4.000

Attention: The coordinates refer to the image above. Values in Lux.

Grid: 1 x 2 Points

E_{av} [lx]	E_{min} [lx]	E_{max} [lx]	u0	E_{min} / E_{max}
3.30	3.27	3.34	0.99	0.98

MIDSTREAM LIGHTING LIMITED
 WESSEX HOUSE
 1 CHESHAM STREET
 LONDON, SW 1X 8ND, UNITED KINGDOM

Operator MIDSTREAM LIGHTING LIMITED
 Telephone +44 (0)207 584 8310
 Fax
 e-Mail info@midstreamlighting.com

Half Pitch 2 / Spill Out - House 8 / Table (E, Perpendicular)



Position of surface in external scene:
 Marked point: (116.882 m, -32.699 m,
 0.000 m)



1.000 2.54

0.000 2.61

m **4.000**

Attention: The coordinates refer to the image above. Values in Lux.

Grid: 1 x 2 Points

E_{av} [lx]	E_{min} [lx]	E_{max} [lx]	u0	E_{min} / E_{max}
2.57	2.54	2.61	0.99	0.98

MIDSTREAM LIGHTING LIMITED
 WESSEX HOUSE
 1 CHESHAM STREET
 LONDON, SW 1X 8ND, UNITED KINGDOM

Operator MIDSTREAM LIGHTING LIMITED
 Telephone +44 (0)207 584 8310
 Fax
 e-Mail info@midstreamlighting.com

Half Pitch 2 / Spill Out - House 9 / Table (E, Perpendicular)



Position of surface in external scene:
 Marked point: (120.096 m, -43.937 m,
 0.000 m)



1.000 1.94

0.000 1.99

m 4.500

Attention: The coordinates refer to the image above. Values in Lux.

Grid: 1 x 2 Points

E_{av} [lx]	E_{min} [lx]	E_{max} [lx]	u0	E_{min} / E_{max}
1.96	1.94	1.99	0.99	0.98

MIDSTREAM LIGHTING LIMITED
 WESSEX HOUSE
 1 CHESHAM STREET
 LONDON, SW 1X 8ND, UNITED KINGDOM

Operator MIDSTREAM LIGHTING LIMITED
 Telephone +44 (0)207 584 8310
 Fax
 e-Mail info@midstreamlighting.com

Half Pitch 2 / Spill Out - House 10 / Table (E, Perpendicular)



Position of surface in external scene:
 Marked point: (122.381 m, -56.528 m,
 0.000 m)

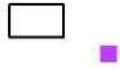

1.000 1.60

0.000 1.63

m **4.000**

Attention: The coordinates refer to the image above. Values in Lux.

Grid: 1 x 2 Points

E_{av} [lx]
1.61

E_{min} [lx]
1.60

E_{max} [lx]
1.63

u_0
0.99

E_{min} / E_{max}
0.98

MIDSTREAM LIGHTING LIMITED
 WESSEX HOUSE
 1 CHESHAM STREET
 LONDON, SW 1X 8ND, UNITED KINGDOM

Operator MIDSTREAM LIGHTING LIMITED
 Telephone +44 (0)207 584 8310
 Fax
 e-Mail info@midstreamlighting.com

Half Pitch 2 / Spill Out - House 11 / Table (E, Perpendicular)



Position of surface in external scene:
 Marked point: (124.128 m, -67.767 m,
 0.000 m)

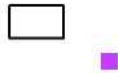

1.000 1.39

0.000 1.42

m 4.500

Attention: The coordinates refer to the image above. Values in Lux.

Grid: 1 x 2 Points

E_{av} [lx]	E_{min} [lx]	E_{max} [lx]	$u0$	E_{min} / E_{max}
1.40	1.39	1.42	0.99	0.98

MIDSTREAM LIGHTING LIMITED
 WESSEX HOUSE
 1 CHESHAM STREET
 LONDON, SW 1X 8ND, UNITED KINGDOM

Operator MIDSTREAM LIGHTING LIMITED
 Telephone +44 (0)207 584 8310
 Fax
 e-Mail info@midstreamlighting.com

Half Pitch 2 / Spill Out - House 12 / Table (E, Perpendicular)



Position of surface in external scene:
 Marked point: (127.356 m, -79.016 m,
 0.000 m)

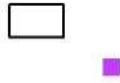

1.000 1.20

0.000 1.23

m 3.500

Attention: The coordinates refer to the image above. Values in Lux.

Grid: 1 x 2 Points

E_{av} [lx]	E_{min} [lx]	E_{max} [lx]	u0	E_{min} / E_{max}
1.21	1.20	1.23	0.99	0.97

MIDSTREAM LIGHTING LIMITED
 WESSEX HOUSE
 1 CHESHAM STREET
 LONDON, SW 1X 8ND, UNITED KINGDOM

Operator MIDSTREAM LIGHTING LIMITED
 Telephone +44 (0)207 584 8310
 Fax
 e-Mail info@midstreamlighting.com

Half Pitch 2 / Spill Out - House 13 / Table (E, Perpendicular)



Position of surface in external scene:
 Marked point: (128.212 m, -88.548 m,
 0.000 m)



1.000 1.07

0.000 1.11

m 3.500

Attention: The coordinates refer to the image above. Values in Lux.

Grid: 1 x 2 Points

E_{av} [lx]	E_{min} [lx]	E_{max} [lx]	u0	E_{min} / E_{max}
1.09	1.07	1.11	0.98	0.96

MIDSTREAM LIGHTING LIMITED
 WESSEX HOUSE
 1 CHESHAM STREET
 LONDON, SW 1X 8ND, UNITED KINGDOM

Operator MIDSTREAM LIGHTING LIMITED
 Telephone +44 (0)207 584 8310
 Fax
 e-Mail info@midstreamlighting.com

Half Pitch 2 / Spill Out - House 14 / Table (E, Perpendicular)



Position of surface in external scene:
 Marked point: (129.958 m, -99.421 m,
 0.000 m)



1.000 0.93

0.000 0.97

m **4.000**

Attention: The coordinates refer to the image above. Values in Lux.

Grid: 1 x 2 Points

E_{av} [lx]
 0.95

E_{min} [lx]
 0.93

E_{max} [lx]
 0.97

u_0
 0.98

E_{min} / E_{max}
 0.96

MIDSTREAM LIGHTING LIMITED
 WESSEX HOUSE
 1 CHESHAM STREET
 LONDON, SW 1X 8ND, UNITED KINGDOM

Operator MIDSTREAM LIGHTING LIMITED
 Telephone +44 (0)207 584 8310
 Fax
 e-Mail info@midstreamlighting.com

Half Pitch 2 / Spill Out - House 15 / Table (E, Perpendicular)



Position of surface in external scene:
 Marked point: (131.965 m, -
 109.204 m, 0.000 m)



1.000 0.83

0.000 0.86

m 3.000

Attention: The coordinates refer to the image above. Values in Lux.

Grid: 1 x 2 Points

E_{av} [lx]	E_{min} [lx]	E_{max} [lx]	$u0$	E_{min} / E_{max}
0.85	0.83	0.86	0.98	0.96

MIDSTREAM LIGHTING LIMITED
 WESSEX HOUSE
 1 CHESHAM STREET
 LONDON, SW 1X 8ND, UNITED KINGDOM

Operator MIDSTREAM LIGHTING LIMITED
 Telephone +44 (0)207 584 8310
 Fax
 e-Mail info@midstreamlighting.com

Half Pitch 2 / Spill Out - House 16 / Table (E, Perpendicular)



Position of surface in external scene:
 Marked point: (133.857 m, -
 122.247 m, 0.000 m)



1.000 0.76

0.000 0.79

m 9.500

Attention: The coordinates refer to the image above. Values in Lux.

Grid: 1 x 2 Points

E_{av} [lx]
0.78

E_{min} [lx]
0.76

E_{max} [lx]
0.79

u_0
0.98

E_{min} / E_{max}
0.96

MIDSTREAM LIGHTING LIMITED
 WESSEX HOUSE
 1 CHESHAM STREET
 LONDON, SW 1X 8ND, UNITED KINGDOM

Operator MIDSTREAM LIGHTING LIMITED
 Telephone +44 (0)207 584 8310
 Fax
 e-Mail info@midstreamlighting.com

Half Pitch 2 / Spill Out - House 17 / Table (E, Perpendicular)



Position of surface in external scene:
 Marked point: (137.862 m, -
 148.129 m, 0.000 m)



1.000 0.68

0.000 0.70

m 3.500

Attention: The coordinates refer to the image above. Values in Lux.

Grid: 1 x 2 Points

E_{av} [lx]
0.69

E_{min} [lx]
0.68

E_{max} [lx]
0.70

u0
0.98

E_{min} / E_{max}
0.96

MIDSTREAM LIGHTING LIMITED
 WESSEX HOUSE
 1 CHESHAM STREET
 LONDON, SW 1X 8ND, UNITED KINGDOM

Operator MIDSTREAM LIGHTING LIMITED
 Telephone +44 (0)207 584 8310
 Fax
 e-Mail info@midstreamlighting.com

Half Pitch 2 / Spill Out - House 18 / Table (E, Perpendicular)



Position of surface in external scene:
 Marked point: (127.153 m, -
 157.373 m, 1.000 m)



1.000 1.10

0.000 1.05

m 3.500

Attention: The coordinates refer to the image above. Values in Lux.

Grid: 1 x 2 Points

E_{av} [lx]
1.08

E_{min} [lx]
1.05

E_{max} [lx]
1.10

u0
0.98

E_{min} / E_{max}
0.96

MIDSTREAM LIGHTING LIMITED
 WESSEX HOUSE
 1 CHESHAM STREET
 LONDON, SW 1X 8ND, UNITED KINGDOM

Operator MIDSTREAM LIGHTING LIMITED
 Telephone +44 (0)207 584 8310
 Fax
 e-Mail info@midstreamlighting.com

Half Pitch 2 / Spill Out - House 19 / Table (E, Perpendicular)



Position of surface in external scene:
 Marked point: (118.099 m, -
 156.395 m, 1.000 m)



1.000 1.25

0.000 1.20

m 4.000

Attention: The coordinates refer to the image above. Values in Lux.

Grid: 1 x 2 Points

E_{av} [lx]
1.22

E_{min} [lx]
1.20

E_{max} [lx]
1.25

u0
0.98

E_{min} / E_{max}
0.96

MIDSTREAM LIGHTING LIMITED
 WESSEX HOUSE
 1 CHESHAM STREET
 LONDON, SW 1X 8ND, UNITED KINGDOM

Operator MIDSTREAM LIGHTING LIMITED
 Telephone +44 (0)207 584 8310
 Fax
 e-Mail info@midstreamlighting.com

Half Pitch 2 / Spill Out - House 20 / Table (E, Perpendicular)



Position of surface in external scene:
 Marked point: (107.345 m, -
 155.662 m, 1.000 m)



1.000 1.47

0.000 1.41

m **4.000**

Attention: The coordinates refer to the image above. Values in Lux.

Grid: 1 x 2 Points

E_{av} [lx]
1.44

E_{min} [lx]
1.41

E_{max} [lx]
1.47

u_0
0.98

E_{min} / E_{max}
0.96

MIDSTREAM LIGHTING LIMITED
 WESSEX HOUSE
 1 CHESHAM STREET
 LONDON, SW 1X 8ND, UNITED KINGDOM

Operator MIDSTREAM LIGHTING LIMITED
 Telephone +44 (0)207 584 8310
 Fax
 e-Mail info@midstreamlighting.com

Half Pitch 2 / Spill Out - House 21 / Table (E, Perpendicular)



Position of surface in external scene:
 Marked point: (96.469 m, -155.051 m,
 1.000 m)



1.000 1.71

0.000 1.63

m **4.000**

Attention: The coordinates refer to the image above. Values in Lux.

Grid: 1 x 2 Points

E_{av} [lx]
1.67

E_{min} [lx]
1.63

E_{max} [lx]
1.71

u_0
0.98

E_{min} / E_{max}
0.95

MIDSTREAM LIGHTING LIMITED
 WESSEX HOUSE
 1 CHESHAM STREET
 LONDON, SW 1X 8ND, UNITED KINGDOM

Operator MIDSTREAM LIGHTING LIMITED
 Telephone +44 (0)207 584 8310
 Fax
 e-Mail info@midstreamlighting.com

Half Pitch 2 / Spill Out - House 22 / Table (E, Perpendicular)



Position of surface in external scene:
 Marked point: (84.104 m, -154.073 m,
 1.000 m)



1.000 1.98

0.000 1.89

m 5.000

Attention: The coordinates refer to the image above. Values in Lux.

Grid: 1 x 2 Points

E_{av} [lx]
1.94

E_{min} [lx]
1.89

E_{max} [lx]
1.98

u_0
0.98

E_{min} / E_{max}
0.95

MIDSTREAM LIGHTING LIMITED
 WESSEX HOUSE
 1 CHESHAM STREET
 LONDON, SW 1X 8ND, UNITED KINGDOM

Operator MIDSTREAM LIGHTING LIMITED
 Telephone +44 (0)207 584 8310
 Fax
 e-Mail info@midstreamlighting.com

Half Pitch 2 / Spill Out - House 23 / Table (E, Perpendicular)



Position of surface in external scene:
 Marked point: (73.995 m, -152.851 m,
 1.000 m)



1.000 2.30

0.000 2.19

m 3.500

Attention: The coordinates refer to the image above. Values in Lux.

Grid: 1 x 2 Points

E_{av} [lx]	E_{min} [lx]	E_{max} [lx]	u0	E_{min} / E_{max}
2.25	2.19	2.30	0.97	0.95

MIDSTREAM LIGHTING LIMITED
 WESSEX HOUSE
 1 CHESHAM STREET
 LONDON, SW 1X 8ND, UNITED KINGDOM

Operator MIDSTREAM LIGHTING LIMITED
 Telephone +44 (0)207 584 8310
 Fax
 e-Mail info@midstreamlighting.com

Half Pitch 2 / Spill Out - House 24 / Table (E, Perpendicular)



Position of surface in external scene:
 Marked point: (64.097 m, -152.118 m,
 1.000 m)



1.000 2.59

0.000 2.45

m 3.500

Attention: The coordinates refer to the image above. Values in Lux.

Grid: 1 x 2 Points

E_{av} [lx]	E_{min} [lx]	E_{max} [lx]	u0	E_{min} / E_{max}
2.52	2.45	2.59	0.97	0.95

MIDSTREAM LIGHTING LIMITED
 WESSEX HOUSE
 1 CHESHAM STREET
 LONDON, SW 1X 8ND, UNITED KINGDOM

Operator MIDSTREAM LIGHTING LIMITED
 Telephone +44 (0)207 584 8310
 Fax
 e-Mail info@midstreamlighting.com

Half Pitch 2 / Spill Out - House 25 / Table (E, Perpendicular)



Position of surface in external scene:
 Marked point: (50.621 m, -151.141 m,
 1.000 m)



1.000 2.96

0.000 2.80

m **5.000**

Attention: The coordinates refer to the image above. Values in Lux.

Grid: 1 x 2 Points

E_{av} [lx]	E_{min} [lx]	E_{max} [lx]	$u0$	E_{min} / E_{max}
2.88	2.80	2.96	0.97	0.95

MIDSTREAM LIGHTING LIMITED
 WESSEX HOUSE
 1 CHESHAM STREET
 LONDON, SW 1X 8ND, UNITED KINGDOM

Operator MIDSTREAM LIGHTING LIMITED
 Telephone +44 (0)207 584 8310
 Fax
 e-Mail info@midstreamlighting.com

Half Pitch 2 / Spill Out - House 26 / Table (E, Perpendicular)



Position of surface in external scene:
 Marked point: (38.401 m, -149.919 m,
 1.000 m)



1.000 3.23

0.000 3.06

m **5.000**

Attention: The coordinates refer to the image above. Values in Lux.

Grid: 1 x 2 Points

E_{av} [lx]	E_{min} [lx]	E_{max} [lx]	$u0$	E_{min} / E_{max}
3.15	3.06	3.23	0.97	0.95

MIDSTREAM LIGHTING LIMITED
 WESSEX HOUSE
 1 CHESHAM STREET
 LONDON, SW 1X 8ND, UNITED KINGDOM

Operator MIDSTREAM LIGHTING LIMITED
 Telephone +44 (0)207 584 8310
 Fax
 e-Mail info@midstreamlighting.com

Half Pitch 2 / Spill Out - House 27 / Table (E, Perpendicular)



Position of surface in external scene:
 Marked point: (24.714 m, -148.819 m,
 1.000 m)



1.000 3.36

0.000 3.18

m 5.000

Attention: The coordinates refer to the image above. Values in Lux.

Grid: 1 x 2 Points

E_{av} [lx]
3.27

E_{min} [lx]
3.18

E_{max} [lx]
3.36

u_0
0.97

E_{min} / E_{max}
0.95

MIDSTREAM LIGHTING LIMITED
 WESSEX HOUSE
 1 CHESHAM STREET
 LONDON, SW 1X 8ND, UNITED KINGDOM

Operator MIDSTREAM LIGHTING LIMITED
 Telephone +44 (0)207 584 8310
 Fax
 e-Mail info@midstreamlighting.com

Half Pitch 2 / Spill Out - House 28 / Table (E, Perpendicular)



Position of surface in external scene:
 Marked point: (3.996 m, -147.274 m,
 1.000 m)



1.000 3.22
0.000 3.09
 m **8.500**

Attention: The coordinates refer to the image above. Values in Lux.

Grid: 1 x 2 Points

E_{av} [lx]	E_{min} [lx]	E_{max} [lx]	u0	E_{min} / E_{max}
3.15	3.09	3.22	0.98	0.96

MIDSTREAM LIGHTING LIMITED
 WESSEX HOUSE
 1 CHESHAM STREET
 LONDON, SW 1X 8ND, UNITED KINGDOM

Operator MIDSTREAM LIGHTING LIMITED
 Telephone +44 (0)207 584 8310
 Fax
 e-Mail info@midstreamlighting.com

Half Pitch 2 / Spill Out - House 29 / Table (E, Perpendicular)



Position of surface in external scene:
 Marked point: (-9.729 m, -146.346 m,
 1.000 m)



1.000 2.94

0.000 2.83

m 4.500

Attention: The coordinates refer to the image above. Values in Lux.

Grid: 1 x 2 Points

E_{av} [lx]	E_{min} [lx]	E_{max} [lx]	$u0$	E_{min} / E_{max}
2.88	2.83	2.94	0.98	0.96

MIDSTREAM LIGHTING LIMITED
 WESSEX HOUSE
 1 CHESHAM STREET
 LONDON, SW 1X 8ND, UNITED KINGDOM

Operator MIDSTREAM LIGHTING LIMITED
 Telephone +44 (0)207 584 8310
 Fax
 e-Mail info@midstreamlighting.com

Half Pitch 2 / Spill Out - House 30 / Table (E, Perpendicular)



Position of surface in external scene:
 Marked point: (-19.295 m, -143.006 m,
 1.000 m)



1.000 2.88

0.000 2.77

m 3.500

Attention: The coordinates refer to the image above. Values in Lux.

Grid: 1 x 2 Points

E_{av} [lx]	E_{min} [lx]	E_{max} [lx]	u0	E_{min} / E_{max}
2.82	2.77	2.88	0.98	0.96

MIDSTREAM LIGHTING LIMITED
 WESSEX HOUSE
 1 CHESHAM STREET
 LONDON, SW 1X 8ND, UNITED KINGDOM

Operator MIDSTREAM LIGHTING LIMITED
 Telephone +44 (0)207 584 8310
 Fax
 e-Mail info@midstreamlighting.com

Half Pitch 2 / Spill Out - House 31 / Table (E, Perpendicular)



Position of surface in external scene:
 Marked point: (-25.649 m, -138.418 m,
 1.000 m)



1.000 2.81

0.000 2.71

m 3.500

Attention: The coordinates refer to the image above. Values in Lux.

Grid: 1 x 2 Points

E_{av} [lx]	E_{min} [lx]	E_{max} [lx]	u0	E_{min} / E_{max}
2.76	2.71	2.81	0.98	0.97

MIDSTREAM LIGHTING LIMITED
 WESSEX HOUSE
 1 CHESHAM STREET
 LONDON, SW 1X 8ND, UNITED KINGDOM

Operator MIDSTREAM LIGHTING LIMITED
 Telephone +44 (0)207 584 8310
 Fax
 e-Mail info@midstreamlighting.com

Half Pitch 2 / Spill Out - House 32 / Table (E, Perpendicular)



Position of surface in external scene:
 Marked point: (-32.537 m, -132.752 m,
 1.000 m)



1.000 3.01

0.000 2.91

m 3.500

Attention: The coordinates refer to the image above. Values in Lux.

Grid: 1 x 2 Points

E_{av} [lx]	E_{min} [lx]	E_{max} [lx]	u0	E_{min} / E_{max}
2.96	2.91	3.01	0.98	0.97

MIDSTREAM LIGHTING LIMITED
 WESSEX HOUSE
 1 CHESHAM STREET
 LONDON, SW 1X 8ND, UNITED KINGDOM

Operator MIDSTREAM LIGHTING LIMITED
 Telephone +44 (0)207 584 8310
 Fax
 e-Mail info@midstreamlighting.com

Half Pitch 2 / Spill Out - House 33 / Table (E, Perpendicular)



Position of surface in external scene:
 Marked point: (-36.002 m, -118.095 m,
 1.000 m)



1.000 1.38

0.000 1.34

m 5.000

Attention: The coordinates refer to the image above. Values in Lux.

Grid: 1 x 2 Points

E_{av} [lx]	E_{min} [lx]	E_{max} [lx]	$u0$	E_{min} / E_{max}
1.36	1.34	1.38	0.98	0.97

MIDSTREAM LIGHTING LIMITED
 WESSEX HOUSE
 1 CHESHAM STREET
 LONDON, SW 1X 8ND, UNITED KINGDOM

Operator MIDSTREAM LIGHTING LIMITED
 Telephone +44 (0)207 584 8310
 Fax
 e-Mail info@midstreamlighting.com

Half Pitch 2 / Spill Out - House 34 / Table (E, Perpendicular)



Position of surface in external scene:
 Marked point: (-38.113 m, -98.543 m,
 1.000 m)



1.000 2.17

0.000 2.07

m 5.000

Attention: The coordinates refer to the image above. Values in Lux.

Grid: 1 x 2 Points

E_{av} [lx]	E_{min} [lx]	E_{max} [lx]	$u0$	E_{min} / E_{max}
2.12	2.07	2.17	0.98	0.96

MIDSTREAM LIGHTING LIMITED
 WESSEX HOUSE
 1 CHESHAM STREET
 LONDON, SW 1X 8ND, UNITED KINGDOM

Operator MIDSTREAM LIGHTING LIMITED
 Telephone +44 (0)207 584 8310
 Fax
 e-Mail info@midstreamlighting.com

Half Pitch 2 / Spill Out - House 35 / Table (E, Perpendicular)



Position of surface in external scene:
 Marked point: (-43.779 m, -72.992 m,
 1.000 m)



1.000 3.53

0.000 3.40

m **5.000**

Attention: The coordinates refer to the image above. Values in Lux.

Grid: 1 x 2 Points

E_{av} [lx]	E_{min} [lx]	E_{max} [lx]	$u0$	E_{min} / E_{max}
3.46	3.40	3.53	0.98	0.96

MIDSTREAM LIGHTING LIMITED
 WESSEX HOUSE
 1 CHESHAM STREET
 LONDON, SW 1X 8ND, UNITED KINGDOM

Operator MIDSTREAM LIGHTING LIMITED
 Telephone +44 (0)207 584 8310
 Fax
 e-Mail info@midstreamlighting.com

Half Pitch 2 / Spill Out - House 36 / Table (E, Perpendicular)



Position of surface in external scene:
 Marked point: (-51.960 m, -51.388 m,
 1.000 m)



1.000 6.27

0.000 6.08

m 5.000

Attention: The coordinates refer to the image above. Values in Lux.

Grid: 1 x 2 Points

E_{av} [lx]
6.17

E_{min} [lx]
6.08

E_{max} [lx]
6.27

$u0$
0.98

E_{min} / E_{max}
0.97

MIDSTREAM LIGHTING LIMITED
 WESSEX HOUSE
 1 CHESHAM STREET
 LONDON, SW 1X 8ND, UNITED KINGDOM

Operator MIDSTREAM LIGHTING LIMITED
 Telephone +44 (0)207 584 8310
 Fax
 e-Mail info@midstreamlighting.com

Half Pitch 2 / Spill Out - House 37 / Table (E, Perpendicular)



Position of surface in external scene:
 Marked point: (-61.264 m, -29.524 m,
 1.000 m)



1.000 9.38

0.000 8.99

m 5.000

Attention: The coordinates refer to the image above. Values in Lux.

Grid: 1 x 2 Points

E_{av} [lx]
9.18

E_{min} [lx]
8.99

E_{max} [lx]
9.38

$u0$
0.98

E_{min} / E_{max}
0.96

MIDSTREAM LIGHTING LIMITED
 WESSEX HOUSE
 1 CHESHAM STREET
 LONDON, SW 1X 8ND, UNITED KINGDOM

Operator MIDSTREAM LIGHTING LIMITED
 Telephone +44 (0)207 584 8310
 Fax
 e-Mail info@midstreamlighting.com

Half Pitch 2 / Spill Out - House 38 / Table (E, Perpendicular)



Position of surface in external scene:
 Marked point: (-71.091 m, -9.441 m,
 1.000 m)



1.000 11

0.000 10

m 4.500

Attention: The coordinates refer to the image above. Values in Lux.

Grid: 1 x 2 Points

E_{av} [lx]	E_{min} [lx]	E_{max} [lx]	u0	E_{min} / E_{max}
11	10	11	0.97	0.95

MIDSTREAM LIGHTING LIMITED
 WESSEX HOUSE
 1 CHESHAM STREET
 LONDON, SW 1X 8ND, UNITED KINGDOM

Operator MIDSTREAM LIGHTING LIMITED
 Telephone +44 (0)207 584 8310
 Fax
 e-Mail info@midstreamlighting.com

Half Pitch 2 / Spill Out - House 39 / Table (E, Perpendicular)



Position of surface in external scene:
 Marked point: (-78.714 m, 3.522 m,
 1.000 m)



1.000 9.19

0.000 8.58

m **6.000**

Attention: The coordinates refer to the image above. Values in Lux.

Grid: 1 x 2 Points

E_{av} [lx]
8.89

E_{min} [lx]
8.58

E_{max} [lx]
9.19

u_0
0.97

E_{min} / E_{max}
0.93

MIDSTREAM LIGHTING LIMITED
 WESSEX HOUSE
 1 CHESHAM STREET
 LONDON, SW 1X 8ND, UNITED KINGDOM

Operator MIDSTREAM LIGHTING LIMITED
 Telephone +44 (0)207 584 8310
 Fax
 e-Mail info@midstreamlighting.com

Half Pitch 2 / Spill Out - House 40 / Table (E, Perpendicular)



Position of surface in external scene:
 Marked point: (-88.370 m, 17.246 m,
 1.000 m)



1.000 5.90

0.000 5.66

m **5.000**

Attention: The coordinates refer to the image above. Values in Lux.

Grid: 1 x 2 Points

E_{av} [lx]	E_{min} [lx]	E_{max} [lx]	$u0$	E_{min} / E_{max}
5.78	5.66	5.90	0.98	0.96

MIDSTREAM LIGHTING LIMITED
 WESSEX HOUSE
 1 CHESHAM STREET
 LONDON, SW 1X 8ND, UNITED KINGDOM

Operator MIDSTREAM LIGHTING LIMITED
 Telephone +44 (0)207 584 8310
 Fax
 e-Mail info@midstreamlighting.com

Half Pitch 2 / Spill Out - House 41 / Table (E, Perpendicular)



Position of surface in external scene:
 Marked point: (-93.814 m, 31.466 m,
 1.000 m)



1.000 4.16

0.000 3.99

m **5.000**

Attention: The coordinates refer to the image above. Values in Lux.

Grid: 1 x 2 Points

E_{av} [lx]	E_{min} [lx]	E_{max} [lx]	$u0$	E_{min} / E_{max}
4.07	3.99	4.16	0.98	0.96

MIDSTREAM LIGHTING LIMITED
 WESSEX HOUSE
 1 CHESHAM STREET
 LONDON, SW 1X 8ND, UNITED KINGDOM

Operator MIDSTREAM LIGHTING LIMITED
 Telephone +44 (0)207 584 8310
 Fax
 e-Mail info@midstreamlighting.com

Half Pitch 2 / Spill Out - House 42 / Table (E, Perpendicular)



Position of surface in external scene:
 Marked point: (-98.702 m, 43.908 m,
 1.000 m)

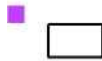

1.000 3.00

0.000 2.87

m **5.000**

Attention: The coordinates refer to the image above. Values in Lux.

Grid: 1 x 2 Points

E_{av} [lx]
2.94

E_{min} [lx]
2.87

E_{max} [lx]
3.00

$u0$
0.98

E_{min} / E_{max}
0.96

MIDSTREAM LIGHTING LIMITED
 WESSEX HOUSE
 1 CHESHAM STREET
 LONDON, SW 1X 8ND, UNITED KINGDOM

Operator MIDSTREAM LIGHTING LIMITED
 Telephone +44 (0)207 584 8310
 Fax
 e-Mail info@midstreamlighting.com

Half Pitch 2 / Spill Out - House 43 / Table (E, Perpendicular)



Position of surface in external scene:
 Marked point: (-101.368 m, 54.906 m,
 1.000 m)

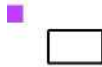

1.000 2.22

0.000 2.13

m **5.000**

Attention: The coordinates refer to the image above. Values in Lux.

Grid: 1 x 2 Points

E_{av} [lx]	E_{min} [lx]	E_{max} [lx]	$u0$	E_{min} / E_{max}
2.18	2.13	2.22	0.98	0.96

MIDSTREAM LIGHTING LIMITED
WESSEX HOUSE
1 CHESHAM STREET
LONDON, SW 1X 8ND, UNITED KINGDOM

Operator MIDSTREAM LIGHTING LIMITED
Telephone +44 (0)207 584 8310
Fax
e-Mail info@midstreamlighting.com

Dimming Full Pitch - 350 lux / Luminaire parts list

20 Pieces MIDSTREAM - Modus S1500 NS (5000K)
Article No.:
Luminous flux (Luminaire): 172248 lm
Luminous flux (Lamps): 172245 lm
Luminaire Wattage: 1500.0 W
Luminaire classification according to CIE: 100
CIE flux code: 24 67 95 100 100
Fitting: 1 x LED (Correction Factor 1.000).

See our luminaire catalog
for an image of the
luminaire.

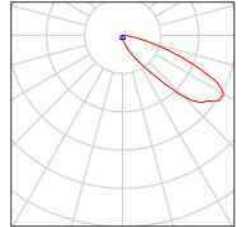

4 Pieces MIDSTREAM - Modus S1500 WS (5000K)
Article No.:
Luminous flux (Luminaire): 172247 lm
Luminous flux (Lamps): 172246 lm
Luminaire Wattage: 1500.0 W
Luminaire classification according to CIE: 100
CIE flux code: 31 67 95 100 100
Fitting: 1 x LED (Correction Factor 1.000).

See our luminaire catalog
for an image of the
luminaire.

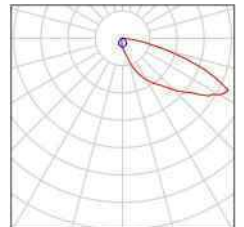

MIDSTREAM LIGHTING LIMITED
 WESSEX HOUSE
 1 CHESHAM STREET
 LONDON, SW 1X 8ND, UNITED KINGDOM

Operator MIDSTREAM LIGHTING LIMITED
 Telephone +44 (0)207 584 8310
 Fax
 e-Mail info@midstreamlighting.com

Dimming Full Pitch - 350 lux / Sport Luminaires (Coordinates List)

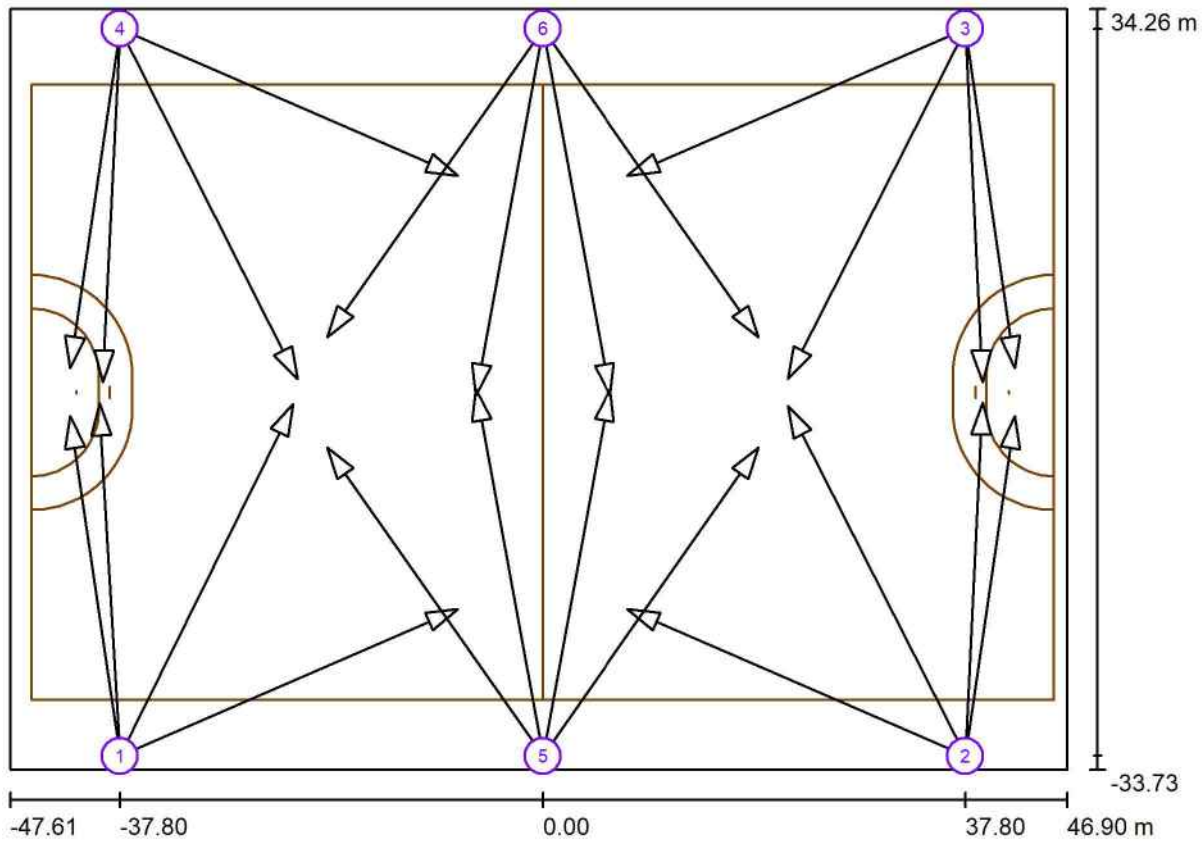

Scale 1 : 676

List of the Sport Luminaires

Luminaire	Index	Position [m]			Aiming Point [m]			Angle [°]	Alignment	Pole
		X	Y	Z	X	Y	Z			
MIDSTREAM - Modus S1500 WS (5000K)	1	-37.800	-32.500	15.000	-42.237	-2.150	0.000	26.1	(C IMax, G IMax)	Pole Position 1
MIDSTREAM - Modus S1500 NS (5000K)	1	-37.800	-32.500	15.000	-39.640	-0.991	0.000	25.4	(C IMax, G IMax)	Pole Position 1
MIDSTREAM - Modus S1500 NS (5000K)	1	-37.800	-32.500	15.000	-22.295	-1.046	0.000	23.2	(C IMax, G IMax)	Pole Position 1
MIDSTREAM - Modus S1500 NS (5000K)	1	-37.800	-32.500	15.000	-7.585	-19.347	0.000	24.5	(C IMax, G IMax)	Pole Position 1

MIDSTREAM LIGHTING LIMITED
 WESSEX HOUSE
 1 CHESHAM STREET
 LONDON, SW 1X 8ND, UNITED KINGDOM

Operator MIDSTREAM LIGHTING LIMITED
 Telephone +44 (0)207 584 8310
 Fax
 e-Mail info@midstreamlighting.com

Dimming Full Pitch - 350 lux / Sport Luminaires (Coordinates List)

List of the Sport Luminaires

Luminaire	Index	Position [m]			Aiming Point [m]			Angle [°]	Alignment	Pole
		X	Y	Z	X	Y	Z			
MIDSTREAM - Modus S1500 NS (5000K)	2	37.800	-32.500	16.000	39.339	-0.927	0.000	26.8	(C IMax, G IMax)	Pole Position 4
MIDSTREAM - Modus S1500 NS (5000K)	2	37.800	-32.500	16.000	21.948	-1.184	0.000	24.5	(C IMax, G IMax)	Pole Position 4
MIDSTREAM - Modus S1500 NS (5000K)	2	37.800	-32.500	16.000	7.585	-19.347	0.000	25.9	(C IMax, G IMax)	Pole Position 4
MIDSTREAM - Modus S1500 WS (5000K)	2	37.800	-32.500	16.000	42.237	-2.150	0.000	27.5	(C IMax, G IMax)	Pole Position 4
MIDSTREAM - Modus S1500 WS (5000K)	3	37.800	32.500	16.000	42.237	2.150	0.000	27.5	(C IMax, G IMax)	Pole Position 5
MIDSTREAM - Modus S1500 WS (5000K)	4	-37.800	32.500	16.000	-42.237	2.150	0.000	27.5	(C IMax, G IMax)	Pole Position 6
MIDSTREAM - Modus S1500 NS (5000K)	3	37.800	32.500	16.000	39.339	0.927	0.000	26.8	(C IMax, G IMax)	Pole Position 5
MIDSTREAM - Modus S1500 NS (5000K)	3	37.800	32.500	16.000	21.948	1.184	0.000	24.5	(C IMax, G IMax)	Pole Position 5
MIDSTREAM - Modus S1500 NS (5000K)	3	37.800	32.500	16.000	7.585	19.347	0.000	25.9	(C IMax, G IMax)	Pole Position 5
MIDSTREAM - Modus S1500 NS (5000K)	4	-37.800	32.500	16.000	-39.339	0.927	0.000	26.8	(C IMax, G IMax)	Pole Position 6
MIDSTREAM - Modus S1500 NS (5000K)	4	-37.800	32.500	16.000	-21.948	1.184	0.000	24.5	(C IMax, G IMax)	Pole Position 6
MIDSTREAM - Modus S1500 NS (5000K)	4	-37.800	32.500	16.000	-7.585	19.347	0.000	25.9	(C IMax, G IMax)	Pole Position 6
MIDSTREAM - Modus S1500 NS (5000K)	5	0.000	-32.500	16.000	-19.303	-4.925	0.000	25.4	(C IMax, G IMax)	Pole Position 2
MIDSTREAM - Modus S1500 NS (5000K)	5	0.000	-32.500	16.000	-6.022	0.300	0.000	25.6	(C IMax, G IMax)	Pole Position 2
MIDSTREAM - Modus S1500 NS (5000K)	5	0.000	-32.500	16.000	19.303	-4.925	0.000	25.4	(C IMax, G IMax)	Pole Position 2
MIDSTREAM - Modus S1500 NS (5000K)	5	0.000	-32.500	16.000	6.022	0.300	0.000	25.6	(C IMax, G IMax)	Pole Position 2
MIDSTREAM - Modus S1500 NS (5000K)	6	0.000	32.500	16.000	-19.303	4.925	0.000	25.4	(C IMax, G IMax)	Pole Position 3
MIDSTREAM - Modus S1500 NS (5000K)	6	0.000	32.500	16.000	-6.022	-0.300	0.000	25.6	(C IMax, G IMax)	Pole Position 3
MIDSTREAM - Modus S1500 NS (5000K)	6	0.000	32.500	16.000	19.303	4.925	0.000	25.4	(C IMax, G IMax)	Pole Position 3
MIDSTREAM - Modus S1500 NS (5000K)	6	0.000	32.500	16.000	6.022	-0.300	0.000	25.6	(C IMax, G IMax)	Pole Position 3

MIDSTREAM LIGHTING LIMITED
 WESSEX HOUSE
 1 CHESHAM STREET
 LONDON, SW 1X 8ND, UNITED KINGDOM

Operator MIDSTREAM LIGHTING LIMITED
 Telephone +44 (0)207 584 8310
 Fax
 e-Mail info@midstreamlighting.com

Dimming Full Pitch - 350 lux / Light scene 1 / Planning data

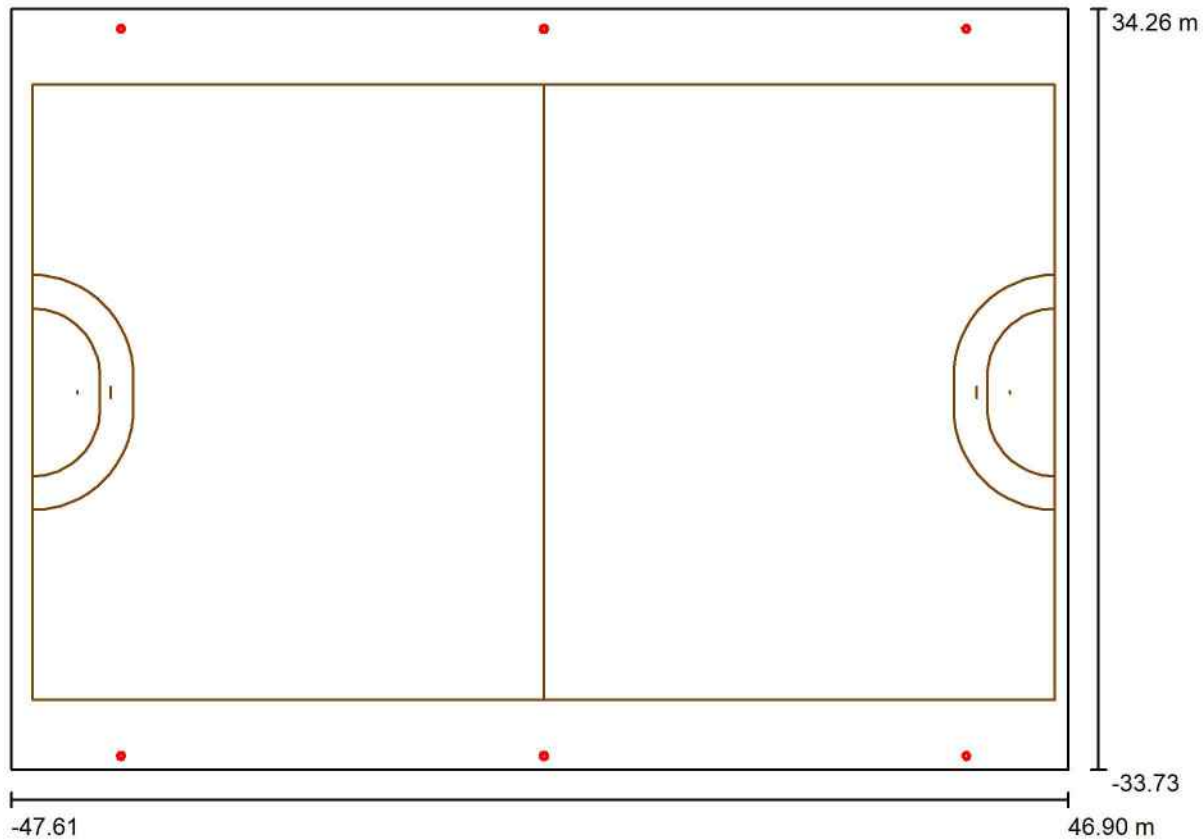

Light loss factor: 0.90, ULR (Upward Light Ratio): 0.5%

Scale 1:676

Luminaire Parts List

No.	Pieces	Designation (Correction Factor)	Φ (Luminaire) [lm]	Φ (Lamps) [lm]	P [W]
1	20	MIDSTREAM - Modus S1500 NS (5000K) (1.000)	172248	172245	1500.0
2	4	MIDSTREAM - Modus S1500 WS (5000K) (1.000)	172247	172246	1500.0
Total:			4133946	Total: 4133884	36000.0

MIDSTREAM LIGHTING LIMITED
 WESSEX HOUSE
 1 CHESHAM STREET
 LONDON, SW 1X 8ND, UNITED KINGDOM

Operator MIDSTREAM LIGHTING LIMITED
 Telephone +44 (0)207 584 8310
 Fax
 e-Mail info@midstreamlighting.com

Dimming Full Pitch - 350 lux / Light scene 1 / GR Observer (Results Overview)

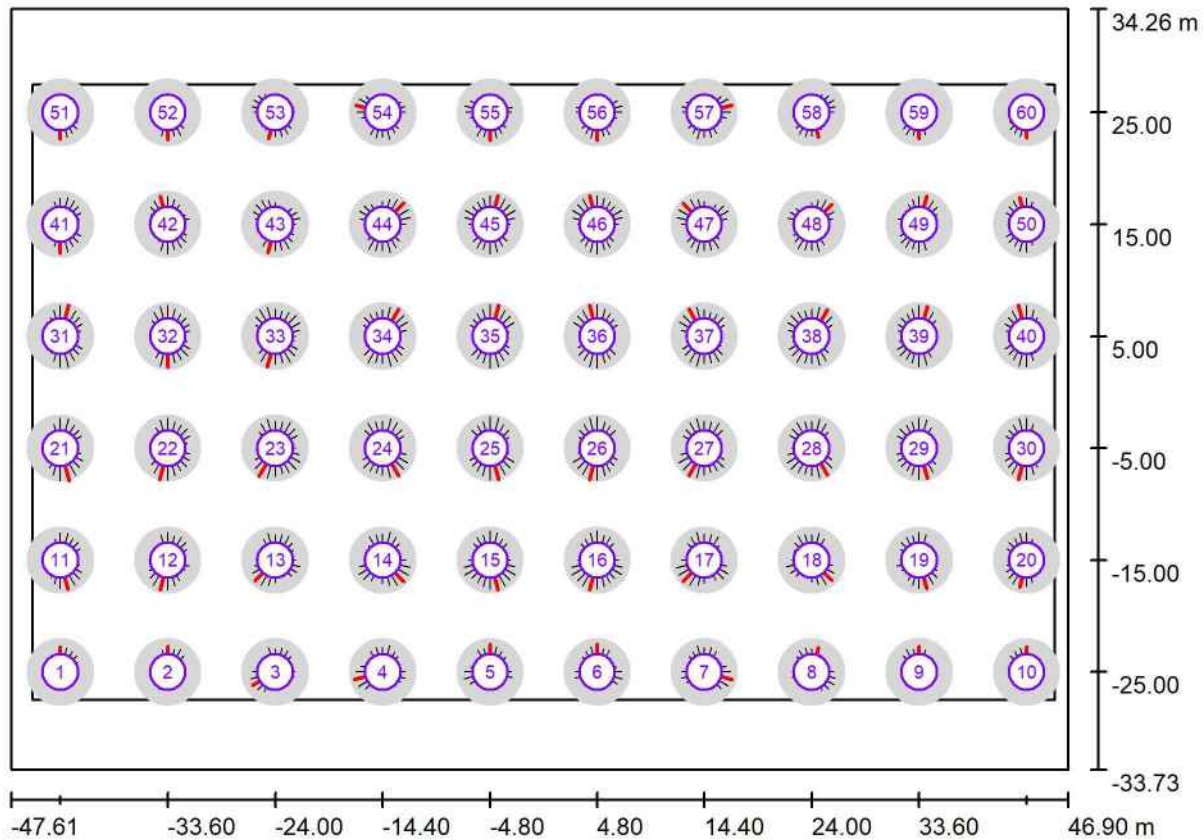

Scale 1 : 676

GR Observerlist

No.	Designation	Position [m]			Viewing sector [°]			Slope angle	Max
		X	Y	Z	Start	End	Increment		
1	GR Observer 1	-43.200	-25.000	1.500	0.0	360.0	15.0	-2.0	34 ²⁾
2	GR Observer 2	-33.600	-25.000	1.500	0.0	360.0	15.0	-2.0	35 ²⁾
3	GR Observer 3	-24.000	-25.000	1.500	0.0	360.0	15.0	-2.0	35 ²⁾
4	GR Observer 4	-14.400	-25.000	1.500	0.0	360.0	15.0	-2.0	39 ²⁾

MIDSTREAM LIGHTING LIMITED
 WESSEX HOUSE
 1 CHESHAM STREET
 LONDON, SW 1X 8ND, UNITED KINGDOM

Operator MIDSTREAM LIGHTING LIMITED
 Telephone +44 (0)207 584 8310
 Fax
 e-Mail info@midstreamlighting.com

Dimming Full Pitch - 350 lux / Light scene 1 / GR Observer (Results Overview)

GR Observerlist

No.	Designation	Position [m]			Viewing sector [°]				Max
		X	Y	Z	Start	End	Increment	Slope angle	
5	GR Observer 5	-4.800	-25.000	1.500	0.0	360.0	15.0	-2.0	37 ²⁾
6	GR Observer 6	4.800	-25.000	1.500	0.0	360.0	15.0	-2.0	37 ²⁾
7	GR Observer 7	14.400	-25.000	1.500	0.0	360.0	15.0	-2.0	38 ²⁾
8	GR Observer 8	24.000	-25.000	1.500	0.0	360.0	15.0	-2.0	34 ²⁾
9	GR Observer 9	33.600	-25.000	1.500	0.0	360.0	15.0	-2.0	35 ²⁾
10	GR Observer 10	43.200	-25.000	1.500	0.0	360.0	15.0	-2.0	34 ²⁾
11	GR Observer 11	-43.200	-15.000	1.500	0.0	360.0	15.0	-2.0	40 ²⁾
12	GR Observer 12	-33.600	-15.000	1.500	0.0	360.0	15.0	-2.0	41 ²⁾
13	GR Observer 13	-24.000	-15.000	1.500	0.0	360.0	15.0	-2.0	39 ²⁾
14	GR Observer 14	-14.400	-15.000	1.500	0.0	360.0	15.0	-2.0	40 ²⁾
15	GR Observer 15	-4.800	-15.000	1.500	0.0	360.0	15.0	-2.0	40 ²⁾
16	GR Observer 16	4.800	-15.000	1.500	0.0	360.0	15.0	-2.0	40 ²⁾
17	GR Observer 17	14.400	-15.000	1.500	0.0	360.0	15.0	-2.0	40 ²⁾
18	GR Observer 18	24.000	-15.000	1.500	0.0	360.0	15.0	-2.0	37 ²⁾
19	GR Observer 19	33.600	-15.000	1.500	0.0	360.0	15.0	-2.0	39 ²⁾
20	GR Observer 20	43.200	-15.000	1.500	0.0	360.0	15.0	-2.0	38 ²⁾
21	GR Observer 21	-43.200	-5.000	1.500	0.0	360.0	15.0	-2.0	45 ²⁾
22	GR Observer 22	-33.600	-5.000	1.500	0.0	360.0	15.0	-2.0	43 ²⁾
23	GR Observer 23	-24.000	-5.000	1.500	0.0	360.0	15.0	-2.0	43 ²⁾
24	GR Observer 24	-14.400	-5.000	1.500	0.0	360.0	15.0	-2.0	42 ²⁾
25	GR Observer 25	-4.800	-5.000	1.500	0.0	360.0	15.0	-2.0	43 ²⁾
26	GR Observer 26	4.800	-5.000	1.500	0.0	360.0	15.0	-2.0	43 ²⁾
27	GR Observer 27	14.400	-5.000	1.500	0.0	360.0	15.0	-2.0	42 ²⁾
28	GR Observer 28	24.000	-5.000	1.500	0.0	360.0	15.0	-2.0	41 ²⁾
29	GR Observer 29	33.600	-5.000	1.500	0.0	360.0	15.0	-2.0	42 ²⁾
30	GR Observer 30	43.200	-5.000	1.500	0.0	360.0	15.0	-2.0	43 ²⁾
31	GR Observer 31	-43.200	5.000	1.500	0.0	360.0	15.0	-2.0	43 ²⁾
32	GR Observer 32	-33.600	5.000	1.500	0.0	360.0	15.0	-2.0	42 ²⁾
33	GR Observer 33	-24.000	5.000	1.500	0.0	360.0	15.0	-2.0	42 ²⁾
34	GR Observer 34	-14.400	5.000	1.500	0.0	360.0	15.0	-2.0	42 ²⁾
35	GR Observer 35	-4.800	5.000	1.500	0.0	360.0	15.0	-2.0	43 ²⁾
36	GR Observer 36	4.800	5.000	1.500	0.0	360.0	15.0	-2.0	43 ²⁾
37	GR Observer 37	14.400	5.000	1.500	0.0	360.0	15.0	-2.0	42 ²⁾
38	GR Observer 38	24.000	5.000	1.500	0.0	360.0	15.0	-2.0	41 ²⁾
39	GR Observer 39	33.600	5.000	1.500	0.0	360.0	15.0	-2.0	42 ²⁾
40	GR Observer 40	43.200	5.000	1.500	0.0	360.0	15.0	-2.0	43 ²⁾

MIDSTREAM LIGHTING LIMITED
 WESSEX HOUSE
 1 CHESHAM STREET
 LONDON, SW 1X 8ND, UNITED KINGDOM

Operator MIDSTREAM LIGHTING LIMITED
 Telephone +44 (0)207 584 8310
 Fax
 e-Mail info@midstreamlighting.com

Dimming Full Pitch - 350 lux / Light scene 1 / GR Observer (Results Overview)

GR Observerlist

No.	Designation	Position [m]			Viewing sector [°]				Max
		X	Y	Z	Start	End	Increment	Slope angle	
41	GR Observer 41	-43.200	15.000	1.500	0.0	360.0	15.0	-2.0	39 ²⁾
42	GR Observer 42	-33.600	15.000	1.500	0.0	360.0	15.0	-2.0	39 ²⁾
43	GR Observer 43	-24.000	15.000	1.500	0.0	360.0	15.0	-2.0	39 ²⁾
44	GR Observer 44	-14.400	15.000	1.500	0.0	360.0	15.0	-2.0	40 ²⁾
45	GR Observer 45	-4.800	15.000	1.500	0.0	360.0	15.0	-2.0	40 ²⁾
46	GR Observer 46	4.800	15.000	1.500	0.0	360.0	15.0	-2.0	40 ²⁾
47	GR Observer 47	14.400	15.000	1.500	0.0	360.0	15.0	-2.0	40 ²⁾
48	GR Observer 48	24.000	15.000	1.500	0.0	360.0	15.0	-2.0	37 ²⁾
49	GR Observer 49	33.600	15.000	1.500	0.0	360.0	15.0	-2.0	39 ²⁾
50	GR Observer 50	43.200	15.000	1.500	0.0	360.0	15.0	-2.0	38 ²⁾
51	GR Observer 51	-43.200	25.000	1.500	0.0	360.0	15.0	-2.0	36 ²⁾
52	GR Observer 52	-33.600	25.000	1.500	0.0	360.0	15.0	-2.0	36 ²⁾
53	GR Observer 53	-24.000	25.000	1.500	0.0	360.0	15.0	-2.0	36 ²⁾
54	GR Observer 54	-14.400	25.000	1.500	0.0	360.0	15.0	-2.0	38 ²⁾
55	GR Observer 55	-4.800	25.000	1.500	0.0	360.0	15.0	-2.0	37 ²⁾
56	GR Observer 56	4.800	25.000	1.500	0.0	360.0	15.0	-2.0	37 ²⁾
57	GR Observer 57	14.400	25.000	1.500	0.0	360.0	15.0	-2.0	38 ²⁾
58	GR Observer 58	24.000	25.000	1.500	0.0	360.0	15.0	-2.0	34 ²⁾
59	GR Observer 59	33.600	25.000	1.500	0.0	360.0	15.0	-2.0	35 ²⁾
60	GR Observer 60	43.200	25.000	1.500	0.0	360.0	15.0	-2.0	34 ²⁾

2) The calculated equivalent veil luminance of the environment is based on the assumption of a complete diffuse reflection behavior of the environment (acc. EN 12464-2).

MIDSTREAM LIGHTING LIMITED
WESSEX HOUSE
1 CHESHAM STREET
LONDON, SW 1X 8ND, UNITED KINGDOM

Operator MIDSTREAM LIGHTING LIMITED
Telephone +44 (0)207 584 8310
Fax
e-Mail info@midstreamlighting.com

Dimming Full Pitch - 350 lux / Light scene 1 / 3D Rendering

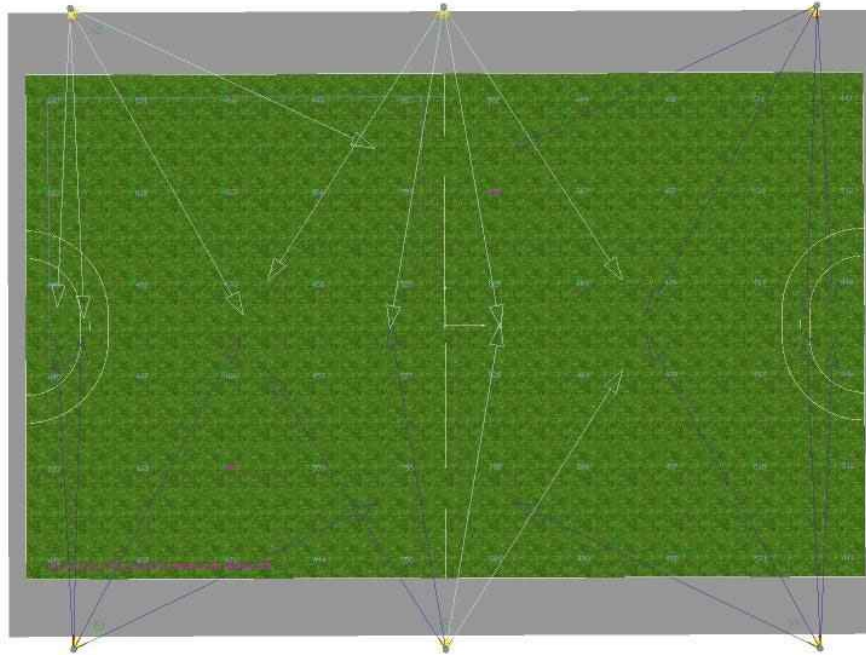

MIDSTREAM LIGHTING LIMITED
WESSEX HOUSE
1 CHESHAM STREET
LONDON, SW 1X 8ND, UNITED KINGDOM

Operator MIDSTREAM LIGHTING LIMITED
Telephone +44 (0)207 584 8310
Fax
e-Mail info@midstreamlighting.com

Dimming Full Pitch - 350 lux / Light scene 1 / False Color Rendering

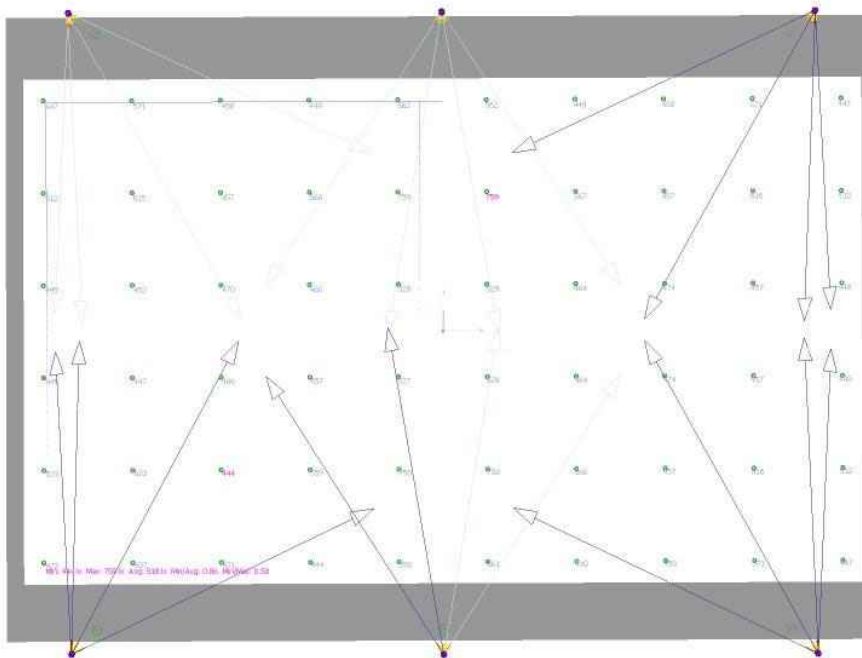

0 43.75 87.50 131.25 175 218.75 262.50 306.25 350

lx

MIDSTREAM LIGHTING LIMITED
 WESSEX HOUSE
 1 CHESHAM STREET
 LONDON, SW 1X 8ND, UNITED KINGDOM

Operator MIDSTREAM LIGHTING LIMITED
 Telephone +44 (0)207 584 8310
 Fax
 e-Mail info@midstreamlighting.com

Dimming Full Pitch - 350 lux / Light scene 1 / Hockey Pitch Calculation Grid / Summary

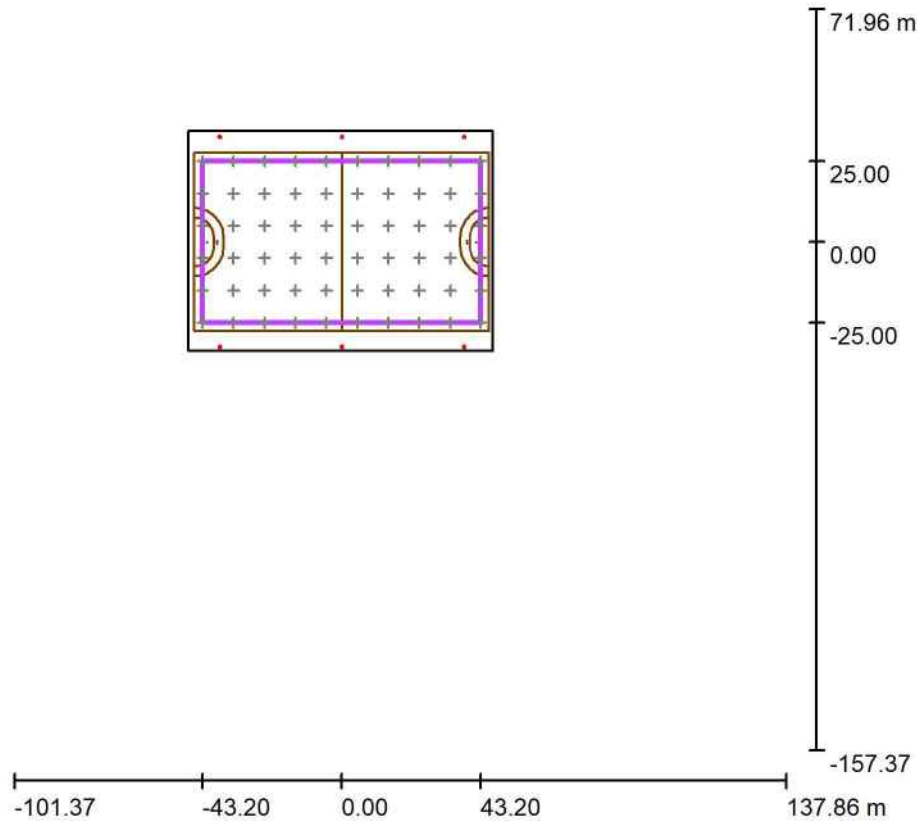

Scale 1 : 2343

Position: (0.000 m, 0.000 m, 0.000 m)
 Size: (86.400 m, 50.000 m)
 Rotation: (0.0°, 0.0°, 0.0°)
 Type: Normal, Grid: 10 x 6 Points
 Belongs to the following sport arena: Hockey Pitch

Results overview

No.	Type	E_{av} [lx]	E_{min} [lx]	E_{max} [lx]	u0	E_{min} / E_{max}	$E_{h\ m} / E_m$	H [m]	Camera
1	horizontal	363	311	531	0.86	0.58	/	0.000	/

$E_{h\ m} / E_m$ = Relationship between middle horizontal and vertical illuminance, H = Measuring Height

MIDSTREAM LIGHTING LIMITED
 WESSEX HOUSE
 1 CHESHAM STREET
 LONDON, SW 1X 8ND, UNITED KINGDOM

Operator MIDSTREAM LIGHTING LIMITED
 Telephone +44 (0)207 584 8310
 Fax
 e-Mail info@midstreamlighting.com

Dimming Full Pitch - 350 lux / Light scene 1 / Hockey Pitch Calculation Grid / Isolines (E, Horizontal)

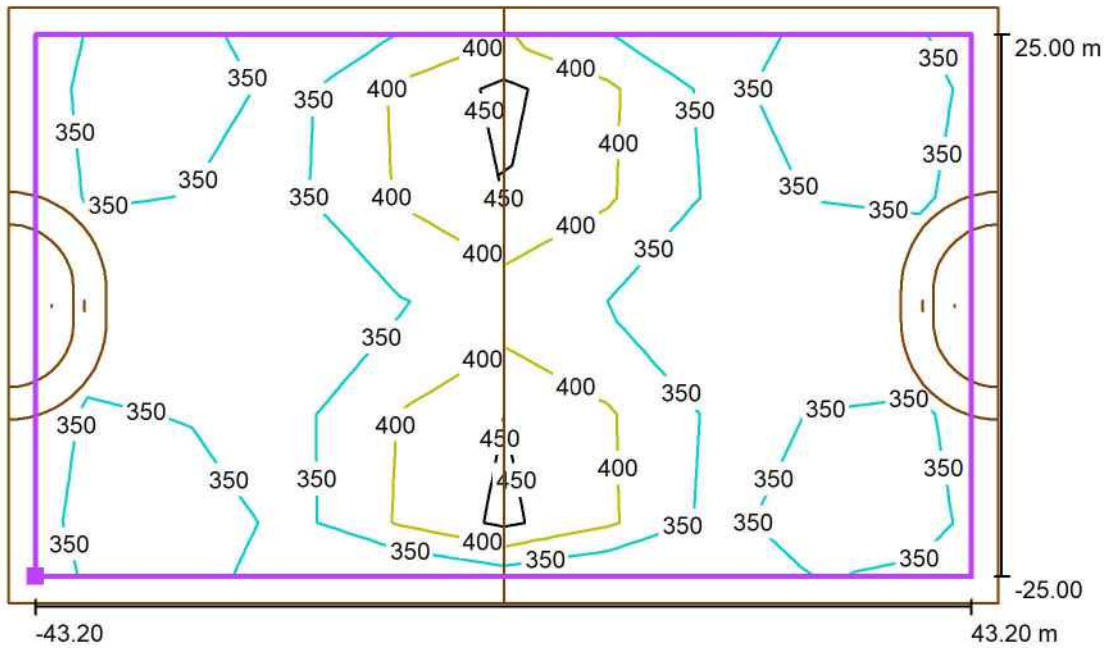

Values in Lux, Scale 1 : 698

Position of surface in external scene:
 Marked point: (-43.200 m, -25.000 m,
 0.000 m)



Grid: 10 x 6 Points

E_{av} [lx]	E_{min} [lx]	E_{max} [lx]	u0	E_{min} / E_{max}
363	311	531	0.86	0.58

MIDSTREAM LIGHTING LIMITED
 WESSEX HOUSE
 1 CHESHAM STREET
 LONDON, SW 1X 8ND, UNITED KINGDOM

Operator MIDSTREAM LIGHTING LIMITED
 Telephone +44 (0)207 584 8310
 Fax
 e-Mail info@midstreamlighting.com

Dimming Full Pitch - 350 lux / Light scene 1 / Hockey Pitch Calculation Grid / Value Chart (E, Horizontal)

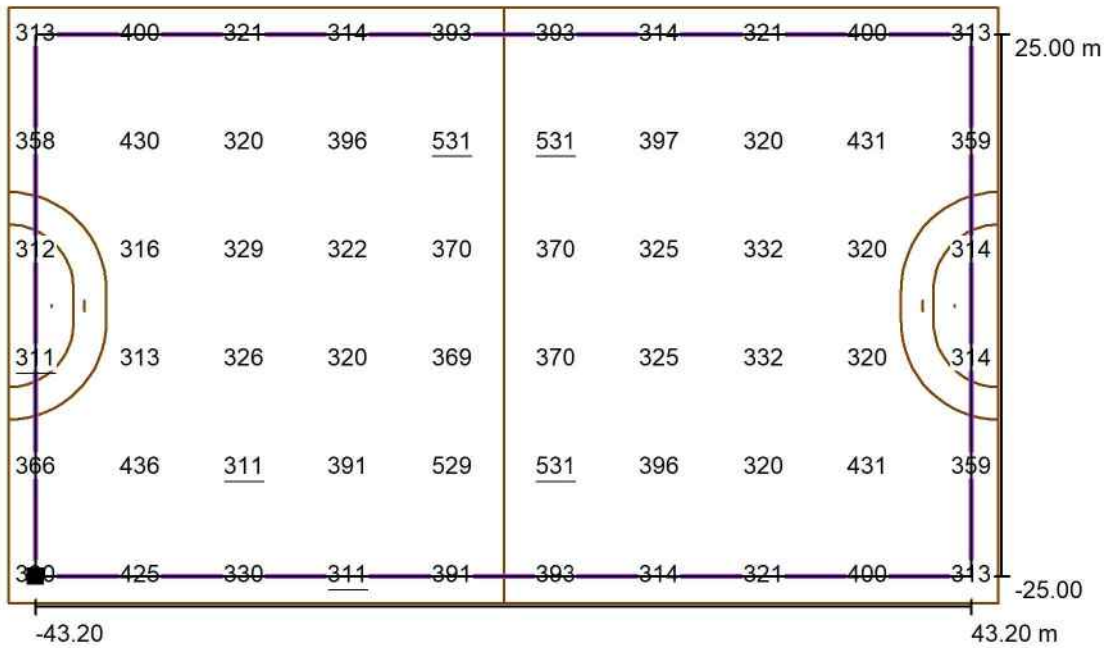

Values in Lux, Scale 1 : 698

Position of surface in external scene:
 Marked point: (-43.200 m, -25.000 m,
 0.000 m)



Grid: 10 x 6 Points

E_{av} [lx]	E_{min} [lx]	E_{max} [lx]	$u0$	E_{min} / E_{max}
363	311	531	0.86	0.58

MIDSTREAM LIGHTING LIMITED
 WESSEX HOUSE
 1 CHESHAM STREET
 LONDON, SW 1X 8ND, UNITED KINGDOM

Operator MIDSTREAM LIGHTING LIMITED
 Telephone +44 (0)207 584 8310
 Fax
 e-Mail info@midstreamlighting.com

Dimming Full Pitch - 350 lux / Light scene 1 / Half Pitch 1 / Summary

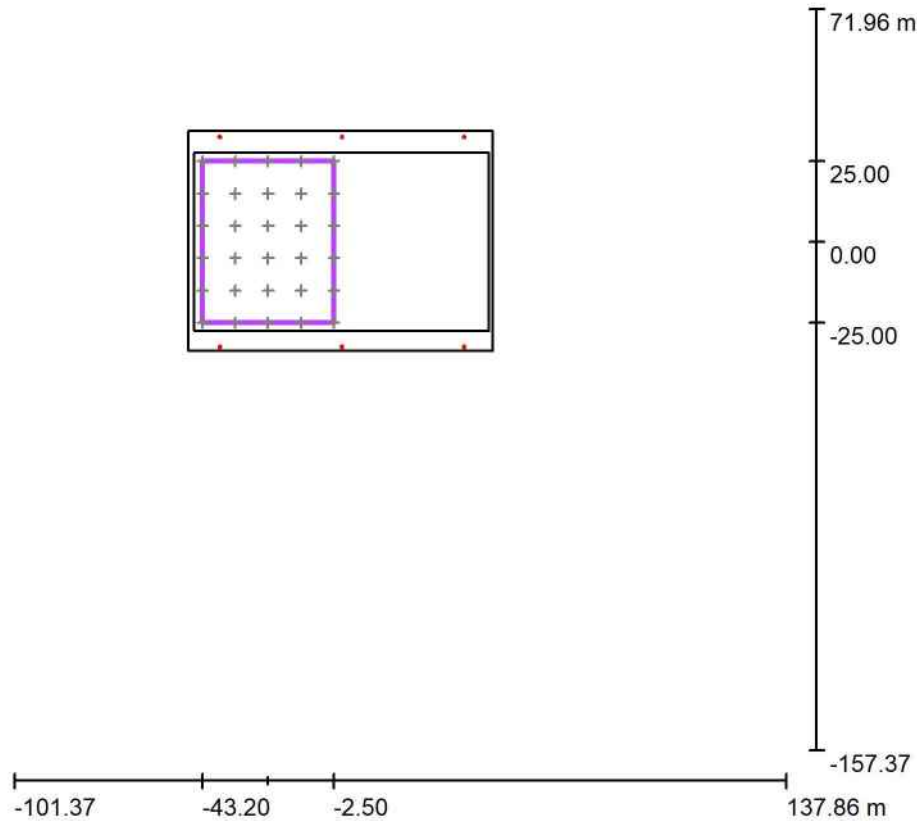

Scale 1 : 2343

Position: (-22.850 m, 0.000 m, 0.000 m)
 Size: (40.700 m, 50.000 m)
 Rotation: (0.0°, 0.0°, 0.0°)
 Type: Normal, Grid: 5 x 6 Points

Results overview

No.	Type	E_{av} [lx]	E_{min} [lx]	E_{max} [lx]	$u0$	E_{min} / E_{max}	$E_{h\ m} / E_m$	H [m]	Camera
1	perpendicular	366	298	547	0.81	0.55	/	0.000	/
2	horizontal	366	298	547	0.81	0.55	/	0.000	/

$E_{h\ m} / E_m$ = Relationship between middle horizontal and vertical illuminance, H = Measuring Height

MIDSTREAM LIGHTING LIMITED
 WESSEX HOUSE
 1 CHESHAM STREET
 LONDON, SW 1X 8ND, UNITED KINGDOM

Operator MIDSTREAM LIGHTING LIMITED
 Telephone +44 (0)207 584 8310
 Fax
 e-Mail info@midstreamlighting.com

Dimming Full Pitch - 350 lux / Light scene 1 / Half Pitch 1 / Value Chart (E, Horizontal)

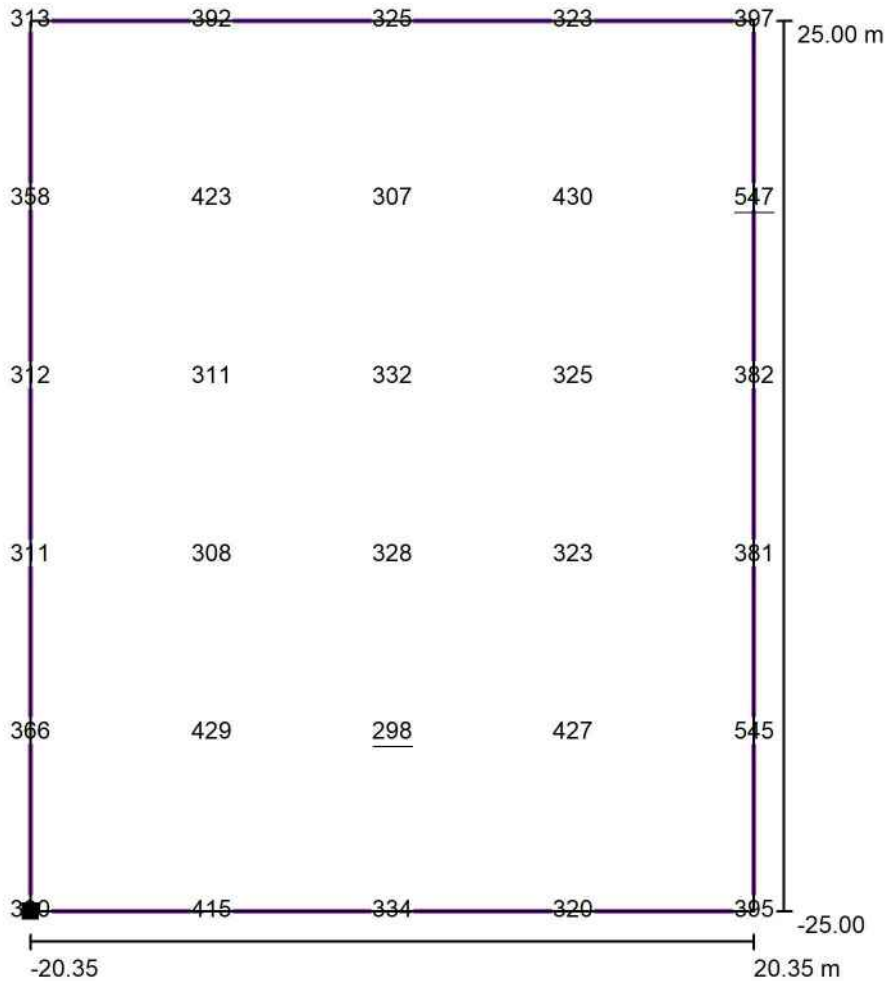

Values in Lux, Scale 1 : 425

Position of surface in external scene:
 Marked point: (-43.200 m, -25.000 m,
 0.000 m)



Grid: 5 x 6 Points

E_{av} [lx]	E_{min} [lx]	E_{max} [lx]	u_0	E_{min} / E_{max}
366	298	547	0.81	0.55

MIDSTREAM LIGHTING LIMITED
 WESSEX HOUSE
 1 CHESHAM STREET
 LONDON, SW 1X 8ND, UNITED KINGDOM

Operator MIDSTREAM LIGHTING LIMITED
 Telephone +44 (0)207 584 8310
 Fax
 e-Mail info@midstreamlighting.com

Dimming Full Pitch - 350 lux / Light scene 1 / Half Pitch 2 / Summary

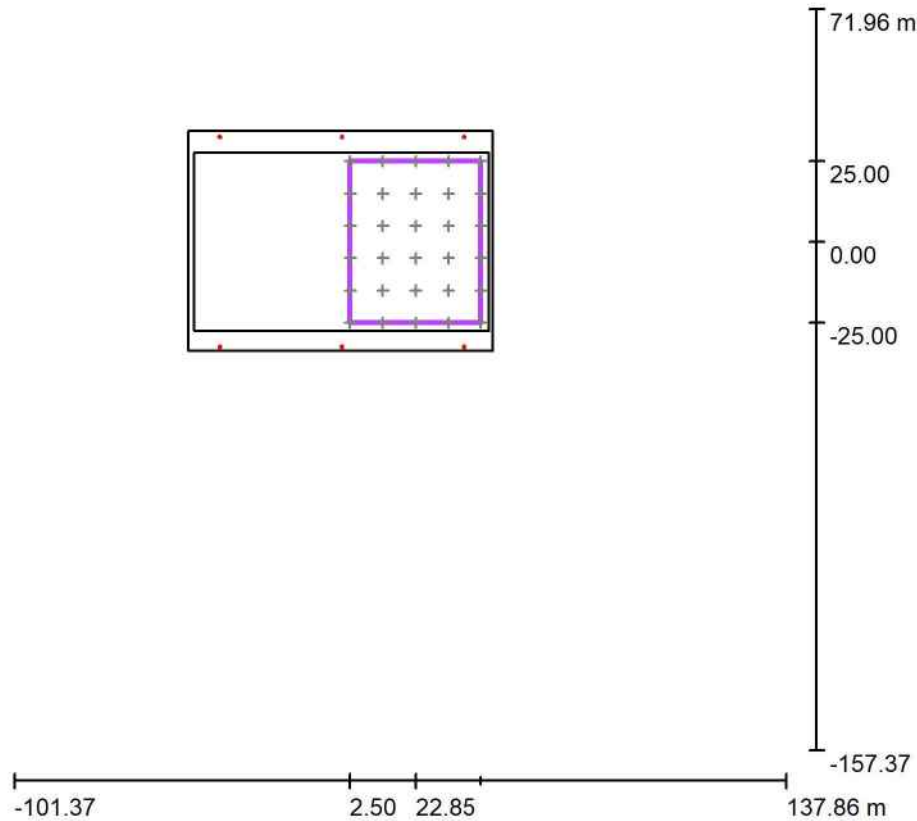

Scale 1 : 2343

Position: (22.850 m, 0.000 m, 0.000 m)
 Size: (40.700 m, 50.000 m)
 Rotation: (0.0°, 0.0°, 0.0°)
 Type: Normal, Grid: 5 x 6 Points

Results overview

No.	Type	E_{av} [lx]	E_{min} [lx]	E_{max} [lx]	$u0$	E_{min} / E_{max}	$E_{h,m} / E_m$	H [m]	Camera
1	horizontal	366	308	547	0.84	0.56	/	0.000	/

$E_{h,m} / E_m$ = Relationship between middle horizontal and vertical illuminance, H = Measuring Height

MIDSTREAM LIGHTING LIMITED
 WESSEX HOUSE
 1 CHESHAM STREET
 LONDON, SW 1X 8ND, UNITED KINGDOM

Operator MIDSTREAM LIGHTING LIMITED
 Telephone +44 (0)207 584 8310
 Fax
 e-Mail info@midstreamlighting.com

Dimming Full Pitch - 350 lux / Light scene 1 / Half Pitch 2 / Value Chart (E, Horizontal)

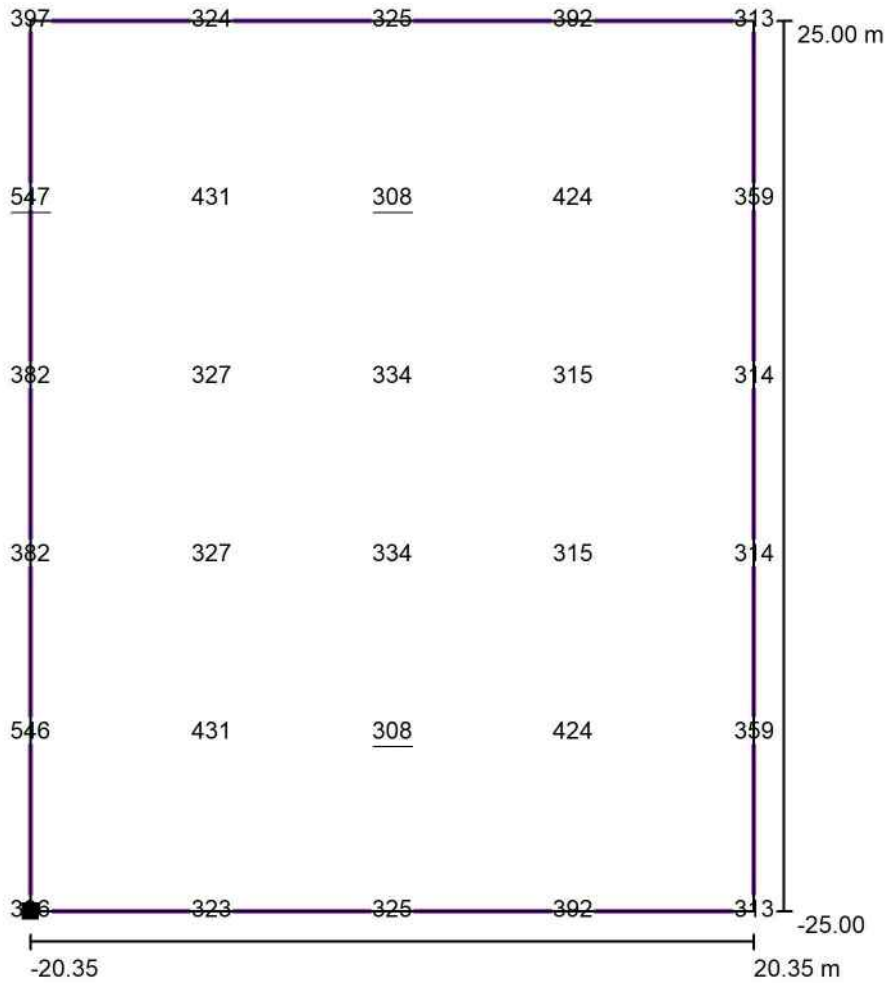

Values in Lux, Scale 1 : 425

Position of surface in external scene:
 Marked point: (2.500 m, -25.000 m,
 0.000 m)



Grid: 5 x 6 Points

E_{av} [lx]	E_{min} [lx]	E_{max} [lx]	$u0$	E_{min} / E_{max}
366	308	547	0.84	0.56

MIDSTREAM LIGHTING LIMITED
 WESSEX HOUSE
 1 CHESHAM STREET
 LONDON, SW 1X 8ND, UNITED KINGDOM

Operator MIDSTREAM LIGHTING LIMITED
 Telephone +44 (0)207 584 8310
 Fax
 e-Mail info@midstreamlighting.com

Dimming Full Pitch - 350 lux / Light scene 1 / Spill Out - House 1 / Table (E, Perpendicular)



Position of surface in external scene:
 Marked point: (105.514 m, 71.961 m,
 0.000 m)

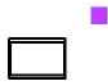

1.000 3.39

0.000 3.52

m 5.000

Attention: The coordinates refer to the image above. Values in Lux.

Grid: 1 x 2 Points

E_{av} [lx]	E_{min} [lx]	E_{max} [lx]	u0	E_{min} / E_{max}
3.45	3.39	3.52	0.98	0.96

MIDSTREAM LIGHTING LIMITED
 WESSEX HOUSE
 1 CHESHAM STREET
 LONDON, SW 1X 8ND, UNITED KINGDOM

Operator MIDSTREAM LIGHTING LIMITED
 Telephone +44 (0)207 584 8310
 Fax
 e-Mail info@midstreamlighting.com

Dimming Full Pitch - 350 lux / Light scene 1 / Spill Out - House 2 / Table (E, Perpendicular)



Position of surface in external scene:
 Marked point: (109.320 m, 43.252 m,
 0.000 m)

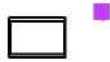

1.000 4.90

0.000 5.09

m 5.000

Attention: The coordinates refer to the image above. Values in Lux.

Grid: 1 x 2 Points

E_{av} [lx]	E_{min} [lx]	E_{max} [lx]	u0	E_{min} / E_{max}
4.99	4.90	5.09	0.98	0.96

MIDSTREAM LIGHTING LIMITED
 WESSEX HOUSE
 1 CHESHAM STREET
 LONDON, SW 1X 8ND, UNITED KINGDOM

Operator MIDSTREAM LIGHTING LIMITED
 Telephone +44 (0)207 584 8310
 Fax
 e-Mail info@midstreamlighting.com

Dimming Full Pitch - 350 lux / Light scene 1 / Spill Out - House 3 / Table (E, Perpendicular)



Position of surface in external scene:
 Marked point: (111.607 m, 27.470 m,
 0.000 m)

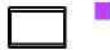

1.000 5.48

0.000 5.68

m 4.000

Attention: The coordinates refer to the image above. Values in Lux.

Grid: 1 x 2 Points

E_{av} [lx]	E_{min} [lx]	E_{max} [lx]	u0	E_{min} / E_{max}
5.58	5.48	5.68	0.98	0.96

MIDSTREAM LIGHTING LIMITED
 WESSEX HOUSE
 1 CHESHAM STREET
 LONDON, SW 1X 8ND, UNITED KINGDOM

Operator MIDSTREAM LIGHTING LIMITED
 Telephone +44 (0)207 584 8310
 Fax
 e-Mail info@midstreamlighting.com

Dimming Full Pitch - 350 lux / Light scene 1 / Spill Out - House 4 / Table (E, Perpendicular)



Position of surface in external scene:
 Marked point: (112.554 m, 17.411 m,
 0.000 m)



1.000 5.61

0.000 5.81

m 5.000

Attention: The coordinates refer to the image above. Values in Lux.

Grid: 1 x 2 Points

E_{av} [lx]
5.71

E_{min} [lx]
5.61

E_{max} [lx]
5.81

u0
0.98

E_{min} / E_{max}
0.97

MIDSTREAM LIGHTING LIMITED
 WESSEX HOUSE
 1 CHESHAM STREET
 LONDON, SW 1X 8ND, UNITED KINGDOM

Operator MIDSTREAM LIGHTING LIMITED
 Telephone +44 (0)207 584 8310
 Fax
 e-Mail info@midstreamlighting.com

Dimming Full Pitch - 350 lux / Light scene 1 / Spill Out - House 5 / Table (E, Perpendicular)



Position of surface in external scene:
 Marked point: (112.921 m, 4.824 m,
 0.000 m)



1.000 5.57

0.000 5.79

m **5.000**

Attention: The coordinates refer to the image above. Values in Lux.

Grid: 1 x 2 Points

E_{av} [lx]
5.68

E_{min} [lx]
5.57

E_{max} [lx]
5.79

u0
0.98

E_{min} / E_{max}
0.96

MIDSTREAM LIGHTING LIMITED
 WESSEX HOUSE
 1 CHESHAM STREET
 LONDON, SW 1X 8ND, UNITED KINGDOM

Operator MIDSTREAM LIGHTING LIMITED
 Telephone +44 (0)207 584 8310
 Fax
 e-Mail info@midstreamlighting.com

Dimming Full Pitch - 350 lux / Light scene 1 / Spill Out - House 6 / Table (E, Perpendicular)



Position of surface in external scene:
 Marked point: (114.805 m, -9.359 m,
 0.000 m)

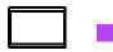

1.000 4.92

0.000 5.12

m 4.000

Attention: The coordinates refer to the image above. Values in Lux.

Grid: 1 x 2 Points

E_{av} [lx]	E_{min} [lx]	E_{max} [lx]	u0	E_{min} / E_{max}
5.02	4.92	5.12	0.98	0.96

MIDSTREAM LIGHTING LIMITED
 WESSEX HOUSE
 1 CHESHAM STREET
 LONDON, SW 1X 8ND, UNITED KINGDOM

Operator MIDSTREAM LIGHTING LIMITED
 Telephone +44 (0)207 584 8310
 Fax
 e-Mail info@midstreamlighting.com

Dimming Full Pitch - 350 lux / Light scene 1 / Spill Out - House 7 / Table (E, Perpendicular)



Position of surface in external scene:
 Marked point: (115.660 m, -20.479 m, 0.000 m)

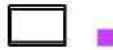

1.000 4.28
0.000 4.45
 m **4.000**

Attention: The coordinates refer to the image above. Values in Lux.

Grid: 1 x 2 Points

E_{av} [lx]	E_{min} [lx]	E_{max} [lx]	$u0$	E_{min} / E_{max}
4.37	4.28	4.45	0.98	0.96

MIDSTREAM LIGHTING LIMITED
 WESSEX HOUSE
 1 CHESHAM STREET
 LONDON, SW 1X 8ND, UNITED KINGDOM

Operator MIDSTREAM LIGHTING LIMITED
 Telephone +44 (0)207 584 8310
 Fax
 e-Mail info@midstreamlighting.com

Dimming Full Pitch - 350 lux / Light scene 1 / Spill Out - House 8 / Table (E, Perpendicular)



Position of surface in external scene:
 Marked point: (116.882 m, -32.699 m, 0.000 m)



1.000 3.45
0.000 3.61
 m **4.000**

Attention: The coordinates refer to the image above. Values in Lux.

Grid: 1 x 2 Points

E_{av} [lx]	E_{min} [lx]	E_{max} [lx]	u0	E_{min} / E_{max}
3.53	3.45	3.61	0.98	0.96

MIDSTREAM LIGHTING LIMITED
 WESSEX HOUSE
 1 CHESHAM STREET
 LONDON, SW 1X 8ND, UNITED KINGDOM

Operator MIDSTREAM LIGHTING LIMITED
 Telephone +44 (0)207 584 8310
 Fax
 e-Mail info@midstreamlighting.com

Dimming Full Pitch - 350 lux / Light scene 1 / Spill Out - House 9 / Table (E, Perpendicular)



Position of surface in external scene:
 Marked point: (120.096 m, -43.937 m,
 0.000 m)



1.000 2.70

0.000 2.81

m 4.500

Attention: The coordinates refer to the image above. Values in Lux.

Grid: 1 x 2 Points

E_{av} [lx]	E_{min} [lx]	E_{max} [lx]	u0	E_{min} / E_{max}
2.76	2.70	2.81	0.98	0.96

MIDSTREAM LIGHTING LIMITED
 WESSEX HOUSE
 1 CHESHAM STREET
 LONDON, SW 1X 8ND, UNITED KINGDOM

Operator MIDSTREAM LIGHTING LIMITED
 Telephone +44 (0)207 584 8310
 Fax
 e-Mail info@midstreamlighting.com

Dimming Full Pitch - 350 lux / Light scene 1 / Spill Out - House 10 / Table (E, Perpendicular)



Position of surface in external scene:
 Marked point: (122.381 m, -56.528 m,
 0.000 m)



1.000 2.19

0.000 2.27

m 4.000

Attention: The coordinates refer to the image above. Values in Lux.

Grid: 1 x 2 Points

E_{av} [lx]	E_{min} [lx]	E_{max} [lx]	u0	E_{min} / E_{max}
2.23	2.19	2.27	0.98	0.96

MIDSTREAM LIGHTING LIMITED
 WESSEX HOUSE
 1 CHESHAM STREET
 LONDON, SW 1X 8ND, UNITED KINGDOM

Operator MIDSTREAM LIGHTING LIMITED
 Telephone +44 (0)207 584 8310
 Fax
 e-Mail info@midstreamlighting.com

Dimming Full Pitch - 350 lux / Light scene 1 / Spill Out - House 11 / Table (E, Perpendicular)



Position of surface in external scene:
 Marked point: (124.128 m, -67.767 m,
 0.000 m)

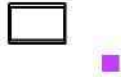

1.000 1.82

0.000 1.89

m 4.500

Attention: The coordinates refer to the image above. Values in Lux.

Grid: 1 x 2 Points

E_{av} [lx]	E_{min} [lx]	E_{max} [lx]	u0	E_{min} / E_{max}
1.85	1.82	1.89	0.98	0.96

MIDSTREAM LIGHTING LIMITED
 WESSEX HOUSE
 1 CHESHAM STREET
 LONDON, SW 1X 8ND, UNITED KINGDOM

Operator MIDSTREAM LIGHTING LIMITED
 Telephone +44 (0)207 584 8310
 Fax
 e-Mail info@midstreamlighting.com

Dimming Full Pitch - 350 lux / Light scene 1 / Spill Out - House 12 / Table (E, Perpendicular)



Position of surface in external scene:
 Marked point: (127.356 m, -79.016 m,
 0.000 m)



1.000 1.53

0.000 1.59

m **3.500**

Attention: The coordinates refer to the image above. Values in Lux.

Grid: 1 x 2 Points

E_{av} [lx]	E_{min} [lx]	E_{max} [lx]	u0	E_{min} / E_{max}
1.56	1.53	1.59	0.98	0.96

MIDSTREAM LIGHTING LIMITED
 WESSEX HOUSE
 1 CHESHAM STREET
 LONDON, SW 1X 8ND, UNITED KINGDOM

Operator MIDSTREAM LIGHTING LIMITED
 Telephone +44 (0)207 584 8310
 Fax
 e-Mail info@midstreamlighting.com

Dimming Full Pitch - 350 lux / Light scene 1 / Spill Out - House 13 / Table (E, Perpendicular)



Position of surface in external scene:
 Marked point: (128.212 m, -88.548 m,
 0.000 m)



1.000 1.34

0.000 1.40

m **3.500**

Attention: The coordinates refer to the image above. Values in Lux.

Grid: 1 x 2 Points

E_{av} [lx]	E_{min} [lx]	E_{max} [lx]	u0	E_{min} / E_{max}
1.37	1.34	1.40	0.98	0.96

MIDSTREAM LIGHTING LIMITED
 WESSEX HOUSE
 1 CHESHAM STREET
 LONDON, SW 1X 8ND, UNITED KINGDOM

Operator MIDSTREAM LIGHTING LIMITED
 Telephone +44 (0)207 584 8310
 Fax
 e-Mail info@midstreamlighting.com

Dimming Full Pitch - 350 lux / Light scene 1 / Spill Out - House 14 / Table (E, Perpendicular)



Position of surface in external scene:
 Marked point: (129.958 m, -99.421 m, 0.000 m)



1.000 1.15
0.000 1.20
m 4.000

Attention: The coordinates refer to the image above. Values in Lux.

Grid: 1 x 2 Points

E_{av} [lx]	E_{min} [lx]	E_{max} [lx]	$u0$	E_{min} / E_{max}
1.17	1.15	1.20	0.98	0.96

MIDSTREAM LIGHTING LIMITED
 WESSEX HOUSE
 1 CHESHAM STREET
 LONDON, SW 1X 8ND, UNITED KINGDOM

Operator MIDSTREAM LIGHTING LIMITED
 Telephone +44 (0)207 584 8310
 Fax
 e-Mail info@midstreamlighting.com

Dimming Full Pitch - 350 lux / Light scene 1 / Spill Out - House 15 / Table (E, Perpendicular)



Position of surface in external scene:
 Marked point: (131.965 m, -
 109.204 m, 0.000 m)



1.000 1.02
0.000 1.06
 m **3.000**

Attention: The coordinates refer to the image above. Values in Lux.

Grid: 1 x 2 Points

E_{av} [lx]	E_{min} [lx]	E_{max} [lx]	u_0	E_{min} / E_{max}
1.04	1.02	1.06	0.98	0.96

MIDSTREAM LIGHTING LIMITED
 WESSEX HOUSE
 1 CHESHAM STREET
 LONDON, SW 1X 8ND, UNITED KINGDOM

Operator MIDSTREAM LIGHTING LIMITED
 Telephone +44 (0)207 584 8310
 Fax
 e-Mail info@midstreamlighting.com

Dimming Full Pitch - 350 lux / Light scene 1 / Spill Out - House 16 / Table (E, Perpendicular)



Position of surface in external scene:

Marked point: (133.857 m, -
 122.247 m, 0.000 m)



1.000 0.92

0.000 0.95

m **9.500**

Attention: The coordinates refer to the image above. Values in Lux.

Grid: 1 x 2 Points

E_{av} [lx]	E_{min} [lx]	E_{max} [lx]	u0	E_{min} / E_{max}
0.94	0.92	0.95	0.98	0.96

MIDSTREAM LIGHTING LIMITED
 WESSEX HOUSE
 1 CHESHAM STREET
 LONDON, SW 1X 8ND, UNITED KINGDOM

Operator MIDSTREAM LIGHTING LIMITED
 Telephone +44 (0)207 584 8310
 Fax
 e-Mail info@midstreamlighting.com

Dimming Full Pitch - 350 lux / Light scene 1 / Spill Out - House 17 / Table (E, Perpendicular)



Position of surface in external scene:
 Marked point: (137.862 m, -
 148.129 m, 0.000 m)



1.000 0.82

0.000 0.85

m **3.500**

Attention: The coordinates refer to the image above. Values in Lux.

Grid: 1 x 2 Points

E_{av} [lx]	E_{min} [lx]	E_{max} [lx]	u0	E_{min} / E_{max}
0.83	0.82	0.85	0.98	0.96

MIDSTREAM LIGHTING LIMITED
 WESSEX HOUSE
 1 CHESHAM STREET
 LONDON, SW 1X 8ND, UNITED KINGDOM

Operator MIDSTREAM LIGHTING LIMITED
 Telephone +44 (0)207 584 8310
 Fax
 e-Mail info@midstreamlighting.com

Dimming Full Pitch - 350 lux / Light scene 1 / Spill Out - House 18 / Table (E, Perpendicular)



Position of surface in external scene:
 Marked point: (127.153 m, -
 157.373 m, 1.000 m)



1.000 1.17
0.000 1.12
m **3.500**

Attention: The coordinates refer to the image above. Values in Lux.

Grid: 1 x 2 Points

E_{av} [lx]	E_{min} [lx]	E_{max} [lx]	u0	E_{min} / E_{max}
1.15	1.12	1.17	0.98	0.96

MIDSTREAM LIGHTING LIMITED
 WESSEX HOUSE
 1 CHESHAM STREET
 LONDON, SW 1X 8ND, UNITED KINGDOM

Operator MIDSTREAM LIGHTING LIMITED
 Telephone +44 (0)207 584 8310
 Fax
 e-Mail info@midstreamlighting.com

Dimming Full Pitch - 350 lux / Light scene 1 / Spill Out - House 19 / Table (E, Perpendicular)



Position of surface in external scene:
 Marked point: (118.099 m, -
 156.395 m, 1.000 m)



1.000 1.33

0.000 1.27

m 4.000

Attention: The coordinates refer to the image above. Values in Lux.

Grid: 1 x 2 Points

E_{av} [lx]	E_{min} [lx]	E_{max} [lx]	u0	E_{min} / E_{max}
1.30	1.27	1.33	0.98	0.96

MIDSTREAM LIGHTING LIMITED
 WESSEX HOUSE
 1 CHESHAM STREET
 LONDON, SW 1X 8ND, UNITED KINGDOM

Operator MIDSTREAM LIGHTING LIMITED
 Telephone +44 (0)207 584 8310
 Fax
 e-Mail info@midstreamlighting.com

Dimming Full Pitch - 350 lux / Light scene 1 / Spill Out - House 20 / Table (E, Perpendicular)



Position of surface in external scene:
 Marked point: (107.345 m, -
 155.662 m, 1.000 m)



1.000 1.56
0.000 1.49
m 4.000

Attention: The coordinates refer to the image above. Values in Lux.

Grid: 1 x 2 Points

E_{av} [lx]	E_{min} [lx]	E_{max} [lx]	$u0$	E_{min} / E_{max}
1.53	1.49	1.56	0.98	0.96

MIDSTREAM LIGHTING LIMITED
 WESSEX HOUSE
 1 CHESHAM STREET
 LONDON, SW 1X 8ND, UNITED KINGDOM

Operator MIDSTREAM LIGHTING LIMITED
 Telephone +44 (0)207 584 8310
 Fax
 e-Mail info@midstreamlighting.com

Dimming Full Pitch - 350 lux / Light scene 1 / Spill Out - House 21 / Table (E, Perpendicular)



Position of surface in external scene:
 Marked point: (96.469 m, -155.051 m, 1.000 m)



1.000 1.82
0.000 1.74
 m **4.000**

Attention: The coordinates refer to the image above. Values in Lux.

Grid: 1 x 2 Points

E_{av} [lx]	E_{min} [lx]	E_{max} [lx]	$u0$	E_{min} / E_{max}
1.78	1.74	1.82	0.98	0.95

MIDSTREAM LIGHTING LIMITED
 WESSEX HOUSE
 1 CHESHAM STREET
 LONDON, SW 1X 8ND, UNITED KINGDOM

Operator MIDSTREAM LIGHTING LIMITED
 Telephone +44 (0)207 584 8310
 Fax
 e-Mail info@midstreamlighting.com

Dimming Full Pitch - 350 lux / Light scene 1 / Spill Out - House 22 / Table (E, Perpendicular)



Position of surface in external scene:
 Marked point: (84.104 m, -154.073 m, 1.000 m)



1.000 2.15

0.000 2.05

m **5.000**

Attention: The coordinates refer to the image above. Values in Lux.

Grid: 1 x 2 Points

E_{av} [lx]
2.10

E_{min} [lx]
2.05

E_{max} [lx]
2.15

u0
0.98

E_{min} / E_{max}
0.95

MIDSTREAM LIGHTING LIMITED
 WESSEX HOUSE
 1 CHESHAM STREET
 LONDON, SW 1X 8ND, UNITED KINGDOM

Operator MIDSTREAM LIGHTING LIMITED
 Telephone +44 (0)207 584 8310
 Fax
 e-Mail info@midstreamlighting.com

Dimming Full Pitch - 350 lux / Light scene 1 / Spill Out - House 23 / Table (E, Perpendicular)



Position of surface in external scene:
 Marked point: (73.995 m, -152.851 m,
 1.000 m)



1.000 2.54
0.000 2.41
m **3.500**

Attention: The coordinates refer to the image above. Values in Lux.

Grid: 1 x 2 Points

E_{av} [lx]	E_{min} [lx]	E_{max} [lx]	u0	E_{min} / E_{max}
2.47	2.41	2.54	0.98	0.95

MIDSTREAM LIGHTING LIMITED
 WESSEX HOUSE
 1 CHESHAM STREET
 LONDON, SW 1X 8ND, UNITED KINGDOM

Operator MIDSTREAM LIGHTING LIMITED
 Telephone +44 (0)207 584 8310
 Fax
 e-Mail info@midstreamlighting.com

Dimming Full Pitch - 350 lux / Light scene 1 / Spill Out - House 24 / Table (E, Perpendicular)



Position of surface in external scene:
 Marked point: (64.097 m, -152.118 m, 1.000 m)



1.000 2.87
0.000 2.73
m **3.500**

Attention: The coordinates refer to the image above. Values in Lux.

Grid: 1 x 2 Points

E_{av} [lx]	E_{min} [lx]	E_{max} [lx]	u0	E_{min} / E_{max}
2.80	2.73	2.87	0.97	0.95

MIDSTREAM LIGHTING LIMITED
 WESSEX HOUSE
 1 CHESHAM STREET
 LONDON, SW 1X 8ND, UNITED KINGDOM

Operator MIDSTREAM LIGHTING LIMITED
 Telephone +44 (0)207 584 8310
 Fax
 e-Mail info@midstreamlighting.com

Dimming Full Pitch - 350 lux / Light scene 1 / Spill Out - House 25 / Table (E, Perpendicular)



Position of surface in external scene:
 Marked point: (50.621 m, -151.141 m, 1.000 m)



1.000 3.32

0.000 3.15

m 5.000

Attention: The coordinates refer to the image above. Values in Lux.

Grid: 1 x 2 Points

E_{av} [lx]	E_{min} [lx]	E_{max} [lx]	u0	E_{min} / E_{max}
3.24	3.15	3.32	0.97	0.95

MIDSTREAM LIGHTING LIMITED
 WESSEX HOUSE
 1 CHESHAM STREET
 LONDON, SW 1X 8ND, UNITED KINGDOM

Operator MIDSTREAM LIGHTING LIMITED
 Telephone +44 (0)207 584 8310
 Fax
 e-Mail info@midstreamlighting.com

Dimming Full Pitch - 350 lux / Light scene 1 / Spill Out - House 26 / Table (E, Perpendicular)



Position of surface in external scene:
 Marked point: (38.401 m, -149.919 m,
 1.000 m)



1.000 3.72

0.000 3.53

m **5.000**

Attention: The coordinates refer to the image above. Values in Lux.

Grid: 1 x 2 Points

E_{av} [lx]	E_{min} [lx]	E_{max} [lx]	u0	E_{min} / E_{max}
3.62	3.53	3.72	0.97	0.95

MIDSTREAM LIGHTING LIMITED
 WESSEX HOUSE
 1 CHESHAM STREET
 LONDON, SW 1X 8ND, UNITED KINGDOM

Operator MIDSTREAM LIGHTING LIMITED
 Telephone +44 (0)207 584 8310
 Fax
 e-Mail info@midstreamlighting.com

Dimming Full Pitch - 350 lux / Light scene 1 / Spill Out - House 27 / Table (E, Perpendicular)



Position of surface in external scene:
 Marked point: (24.714 m, -148.819 m, 1.000 m)



1.000 4.03

0.000 3.83

m 5.000

Attention: The coordinates refer to the image above. Values in Lux.

Grid: 1 x 2 Points

E_{av} [lx]
3.93

E_{min} [lx]
3.83

E_{max} [lx]
4.03

u0
0.97

E_{min} / E_{max}
0.95

MIDSTREAM LIGHTING LIMITED
 WESSEX HOUSE
 1 CHESHAM STREET
 LONDON, SW 1X 8ND, UNITED KINGDOM

Operator MIDSTREAM LIGHTING LIMITED
 Telephone +44 (0)207 584 8310
 Fax
 e-Mail info@midstreamlighting.com

Dimming Full Pitch - 350 lux / Light scene 1 / Spill Out - House 28 / Table (E, Perpendicular)



Position of surface in external scene:
 Marked point: (3.996 m, -147.274 m,
 1.000 m)



1.000 4.15

0.000 3.97

m 8.500

Attention: The coordinates refer to the image above. Values in Lux.

Grid: 1 x 2 Points

E_{av} [lx]	E_{min} [lx]	E_{max} [lx]	$u0$	E_{min} / E_{max}
4.06	3.97	4.15	0.98	0.96

MIDSTREAM LIGHTING LIMITED
 WESSEX HOUSE
 1 CHESHAM STREET
 LONDON, SW 1X 8ND, UNITED KINGDOM

Operator MIDSTREAM LIGHTING LIMITED
 Telephone +44 (0)207 584 8310
 Fax
 e-Mail info@midstreamlighting.com

Dimming Full Pitch - 350 lux / Light scene 1 / Spill Out - House 29 / Table (E, Perpendicular)



Position of surface in external scene:
 Marked point: (-9.729 m, -146.346 m,
 1.000 m)



1.000 4.26

0.000 4.08

m 4.500

Attention: The coordinates refer to the image above. Values in Lux.

Grid: 1 x 2 Points

E_{av} [lx]	E_{min} [lx]	E_{max} [lx]	u0	E_{min} / E_{max}
4.17	4.08	4.26	0.98	0.96

MIDSTREAM LIGHTING LIMITED
 WESSEX HOUSE
 1 CHESHAM STREET
 LONDON, SW 1X 8ND, UNITED KINGDOM

Operator MIDSTREAM LIGHTING LIMITED
 Telephone +44 (0)207 584 8310
 Fax
 e-Mail info@midstreamlighting.com

Dimming Full Pitch - 350 lux / Light scene 1 / Spill Out - House 30 / Table (E, Perpendicular)



Position of surface in external scene:
 Marked point: (-19.295 m, -143.006 m,
 1.000 m)



1.000 4.30
0.000 4.11
m **3.500**

Attention: The coordinates refer to the image above. Values in Lux.

Grid: 1 x 2 Points

E_{av} [lx]	E_{min} [lx]	E_{max} [lx]	u_0	E_{min} / E_{max}
4.20	4.11	4.30	0.98	0.95

MIDSTREAM LIGHTING LIMITED
 WESSEX HOUSE
 1 CHESHAM STREET
 LONDON, SW 1X 8ND, UNITED KINGDOM

Operator MIDSTREAM LIGHTING LIMITED
 Telephone +44 (0)207 584 8310
 Fax
 e-Mail info@midstreamlighting.com

Dimming Full Pitch - 350 lux / Light scene 1 / Spill Out - House 31 / Table (E, Perpendicular)



Position of surface in external scene:
 Marked point: (-25.649 m, -138.418 m, 1.000 m)

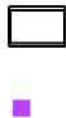

1.000 4.21
0.000 4.00
m **3.500**

Attention: The coordinates refer to the image above. Values in Lux.

Grid: 1 x 2 Points

E_{av} [lx]	E_{min} [lx]	E_{max} [lx]	u0	E_{min} / E_{max}
4.10	4.00	4.21	0.98	0.95

MIDSTREAM LIGHTING LIMITED
 WESSEX HOUSE
 1 CHESHAM STREET
 LONDON, SW 1X 8ND, UNITED KINGDOM

Operator MIDSTREAM LIGHTING LIMITED
 Telephone +44 (0)207 584 8310
 Fax
 e-Mail info@midstreamlighting.com

Dimming Full Pitch - 350 lux / Light scene 1 / Spill Out - House 32 / Table (E, Perpendicular)



Position of surface in external scene:
 Marked point: (-32.537 m, -132.752 m,
 1.000 m)



1.000 4.72

0.000 4.48

m **3.500**

Attention: The coordinates refer to the image above. Values in Lux.

Grid: 1 x 2 Points

E_{av} [lx]	E_{min} [lx]	E_{max} [lx]	u0	E_{min} / E_{max}
4.60	4.48	4.72	0.97	0.95

MIDSTREAM LIGHTING LIMITED
 WESSEX HOUSE
 1 CHESHAM STREET
 LONDON, SW 1X 8ND, UNITED KINGDOM

Operator MIDSTREAM LIGHTING LIMITED
 Telephone +44 (0)207 584 8310
 Fax
 e-Mail info@midstreamlighting.com

Dimming Full Pitch - 350 lux / Light scene 1 / Spill Out - House 33 / Table (E, Perpendicular)



Position of surface in external scene:
 Marked point: (-36.002 m, -118.095 m,
 1.000 m)



1.000 1.40

0.000 1.35

m 5.000

Attention: The coordinates refer to the image above. Values in Lux.

Grid: 1 x 2 Points

E_{av} [lx]	E_{min} [lx]	E_{max} [lx]	u0	E_{min} / E_{max}
1.37	1.35	1.40	0.98	0.96

MIDSTREAM LIGHTING LIMITED
 WESSEX HOUSE
 1 CHESHAM STREET
 LONDON, SW 1X 8ND, UNITED KINGDOM

Operator MIDSTREAM LIGHTING LIMITED
 Telephone +44 (0)207 584 8310
 Fax
 e-Mail info@midstreamlighting.com

Dimming Full Pitch - 350 lux / Light scene 1 / Spill Out - House 34 / Table (E, Perpendicular)



Position of surface in external scene:
 Marked point: (-38.113 m, -98.543 m,
 1.000 m)



1.000 2.27

0.000 2.18

m 5.000

Attention: The coordinates refer to the image above. Values in Lux.

Grid: 1 x 2 Points

E_{av} [lx]
2.23

E_{min} [lx]
2.18

E_{max} [lx]
2.27

u0
0.98

E_{min} / E_{max}
0.96

MIDSTREAM LIGHTING LIMITED
 WESSEX HOUSE
 1 CHESHAM STREET
 LONDON, SW 1X 8ND, UNITED KINGDOM

Operator MIDSTREAM LIGHTING LIMITED
 Telephone +44 (0)207 584 8310
 Fax
 e-Mail info@midstreamlighting.com

Dimming Full Pitch - 350 lux / Light scene 1 / Spill Out - House 35 / Table (E, Perpendicular)



Position of surface in external scene:
 Marked point: (-43.779 m, -72.992 m,
 1.000 m)



1.000 4.53

0.000 4.33

m 5.000

Attention: The coordinates refer to the image above. Values in Lux.

Grid: 1 x 2 Points

E_{av} [lx]
4.43

E_{min} [lx]
4.33

E_{max} [lx]
4.53

u0
0.98

E_{min} / E_{max}
0.96

MIDSTREAM LIGHTING LIMITED
 WESSEX HOUSE
 1 CHESHAM STREET
 LONDON, SW 1X 8ND, UNITED KINGDOM

Operator MIDSTREAM LIGHTING LIMITED
 Telephone +44 (0)207 584 8310
 Fax
 e-Mail info@midstreamlighting.com

Dimming Full Pitch - 350 lux / Light scene 1 / Spill Out - House 36 / Table (E, Perpendicular)



Position of surface in external scene:
 Marked point: (-51.960 m, -51.388 m,
 1.000 m)



1.000 15

0.000 14

m 5.000

Attention: The coordinates refer to the image above. Values in Lux.

Grid: 1 x 2 Points

E_{av} [lx]	E_{min} [lx]	E_{max} [lx]	u0	E_{min} / E_{max}
15	14	15	0.98	0.95

MIDSTREAM LIGHTING LIMITED
 WESSEX HOUSE
 1 CHESHAM STREET
 LONDON, SW 1X 8ND, UNITED KINGDOM

Operator MIDSTREAM LIGHTING LIMITED
 Telephone +44 (0)207 584 8310
 Fax
 e-Mail info@midstreamlighting.com

Dimming Full Pitch - 350 lux / Light scene 1 / Spill Out - House 37 / Table (E, Perpendicular)



Position of surface in external scene:
 Marked point: (-61.264 m, -29.524 m,
 1.000 m)



1.000 39

0.000 38

m 5.000

Attention: The coordinates refer to the image above. Values in Lux.

Grid: 1 x 2 Points

E_{av} [lx]
39

E_{min} [lx]
38

E_{max} [lx]
39

u0
0.99

E_{min} / E_{max}
0.98

MIDSTREAM LIGHTING LIMITED
 WESSEX HOUSE
 1 CHESHAM STREET
 LONDON, SW 1X 8ND, UNITED KINGDOM

Operator MIDSTREAM LIGHTING LIMITED
 Telephone +44 (0)207 584 8310
 Fax
 e-Mail info@midstreamlighting.com

Dimming Full Pitch - 350 lux / Light scene 1 / Spill Out - House 38 / Table (E, Perpendicular)



Position of surface in external scene:
 Marked point: (-71.091 m, -9.441 m,
 1.000 m)



1.000 35

0.000 33

m 4.500

Attention: The coordinates refer to the image above. Values in Lux.

Grid: 1 x 2 Points

E_{av} [lx]	E_{min} [lx]	E_{max} [lx]	u0	E_{min} / E_{max}
34	33	35	0.98	0.96

MIDSTREAM LIGHTING LIMITED
 WESSEX HOUSE
 1 CHESHAM STREET
 LONDON, SW 1X 8ND, UNITED KINGDOM

Operator MIDSTREAM LIGHTING LIMITED
 Telephone +44 (0)207 584 8310
 Fax
 e-Mail info@midstreamlighting.com

Dimming Full Pitch - 350 lux / Light scene 1 / Spill Out - House 39 / Table (E, Perpendicular)



Position of surface in external scene:
 Marked point: (-78.714 m, 3.522 m,
 1.000 m)



1.000 24

0.000 23

m 6.000

Attention: The coordinates refer to the image above. Values in Lux.

Grid: 1 x 2 Points

E_{av} [lx]	E_{min} [lx]	E_{max} [lx]	u0	E_{min} / E_{max}
23	23	24	0.98	0.95

MIDSTREAM LIGHTING LIMITED
 WESSEX HOUSE
 1 CHESHAM STREET
 LONDON, SW 1X 8ND, UNITED KINGDOM

Operator MIDSTREAM LIGHTING LIMITED
 Telephone +44 (0)207 584 8310
 Fax
 e-Mail info@midstreamlighting.com

Dimming Full Pitch - 350 lux / Light scene 1 / Spill Out - House 40 / Table (E, Perpendicular)



Position of surface in external scene:
 Marked point: (-88.370 m, 17.246 m,
 1.000 m)



1.000 13

0.000 12

m 5.000

Attention: The coordinates refer to the image above. Values in Lux.

Grid: 1 x 2 Points

E_{av} [lx]	E_{min} [lx]	E_{max} [lx]	u0	E_{min} / E_{max}
13	12	13	0.99	0.97

MIDSTREAM LIGHTING LIMITED
 WESSEX HOUSE
 1 CHESHAM STREET
 LONDON, SW 1X 8ND, UNITED KINGDOM

Operator MIDSTREAM LIGHTING LIMITED
 Telephone +44 (0)207 584 8310
 Fax
 e-Mail info@midstreamlighting.com

Dimming Full Pitch - 350 lux / Light scene 1 / Spill Out - House 41 / Table (E, Perpendicular)



Position of surface in external scene:
 Marked point: (-93.814 m, 31.466 m,
 1.000 m)

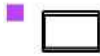

1.000 8.00
0.000 7.73
m **5.000**

Attention: The coordinates refer to the image above. Values in Lux.

Grid: 1 x 2 Points

E_{av} [lx]	E_{min} [lx]	E_{max} [lx]	u0	E_{min} / E_{max}
7.87	7.73	8.00	0.98	0.97

MIDSTREAM LIGHTING LIMITED
 WESSEX HOUSE
 1 CHESHAM STREET
 LONDON, SW 1X 8ND, UNITED KINGDOM

Operator MIDSTREAM LIGHTING LIMITED
 Telephone +44 (0)207 584 8310
 Fax
 e-Mail info@midstreamlighting.com

Dimming Full Pitch - 350 lux / Light scene 1 / Spill Out - House 42 / Table (E, Perpendicular)



Position of surface in external scene:
 Marked point: (-98.702 m, 43.908 m,
 1.000 m)



1.000 4.91

0.000 4.73

m 5.000

Attention: The coordinates refer to the image above. Values in Lux.

Grid: 1 x 2 Points

E_{av} [lx]	E_{min} [lx]	E_{max} [lx]	u0	E_{min} / E_{max}
4.82	4.73	4.91	0.98	0.96

MIDSTREAM LIGHTING LIMITED
 WESSEX HOUSE
 1 CHESHAM STREET
 LONDON, SW 1X 8ND, UNITED KINGDOM

Operator MIDSTREAM LIGHTING LIMITED
 Telephone +44 (0)207 584 8310
 Fax
 e-Mail info@midstreamlighting.com

Dimming Full Pitch - 350 lux / Light scene 1 / Spill Out - House 43 / Table (E, Perpendicular)



Position of surface in external scene:
 Marked point: (-101.368 m, 54.906 m,
 1.000 m)



1.000 3.44

0.000 3.32

m **5.000**

Attention: The coordinates refer to the image above. Values in Lux.

Grid: 1 x 2 Points

E_{av} [lx]
3.38

E_{min} [lx]
3.32

E_{max} [lx]
3.44

u0
0.98

E_{min} / E_{max}
0.96

ML2597 - Brookland Sport Centre - Tennis

MIDSTREAM LED PROPOSAL

REV02

16 x 8.5m Poles

Maintenance Factor: 0.9

Lighting Requirements:

PPA: Eav=500 Lux; Emin/Eav=0.7;

TPA: Eav=400 Lux; Emin/Eav=0.6

Calculated Values:

PPA: Eav=500+ Lux; Emin/Eav>0.7;

TPA: Eav=400+ Lux; Emin/Eav>0.6

1) Only RETROFIT ON

Total Floodlights: 16 x Modus S1100 WS (5000K)

Total Power Installed: 18.9 kW each

2) ALL ON:

Total Floodlights: 24 x Modus S1100 WS (5000K)

Total Power Installed: 28.32 kW

Date: 29.05.2024

Operator: MIDSTREAM LIGHTING LIMITED

MIDSTREAM LIGHTING LIMITED
 WESSEX HOUSE
 1 CHESHAM STREET
 LONDON, SW 1X 8ND, UNITED KINGDOM

Operator MIDSTREAM LIGHTING LIMITED
 Telephone +44 (0)207 584 8310
 Fax
 e-Mail info@midstreamlighting.com

Table of contents

ML2597 - Brookland Sport Centre - Tennis

Project Cover	1
Table of contents	2
MIDSTREAM - Modus S1100 WS (5000K)	
Luminaire Data Sheet	7
Only Retrofits ON	
Planning data	8
Luminaire parts list	9
Luminaires (layout plan)	10
Luminaires (coordinates list)	11
Sport Luminaires (Coordinates List)	12
3D Rendering	14
False Colour Rendering	15
Exterior Surfaces	
Tennis 1 Calculation Grid (TPA)	
Summary	16
Value Chart (E, Horizontal)	17
Tennis 1 Calculation Grid (PPA)	
Summary	18
Value Chart (E, Horizontal)	19
Spill Out - House 1	
Table (E, Perpendicular)	20
Spill Out - House 2	
Table (E, Perpendicular)	21
Spill Out - House 3	
Table (E, Perpendicular)	22
Spill Out - House 4	
Table (E, Perpendicular)	23
Spill Out - House 5	
Table (E, Perpendicular)	24
Spill Out - House 6	
Table (E, Perpendicular)	25
Spill Out - House 7	
Table (E, Perpendicular)	26
Spill Out - House 8	
Table (E, Perpendicular)	27
Spill Out - House 9	
Table (E, Perpendicular)	28
Spill Out - House 10	
Table (E, Perpendicular)	29
Spill Out - House 11	
Table (E, Perpendicular)	30
Spill Out - House 12	
Table (E, Perpendicular)	31
Spill Out - House 13	
Table (E, Perpendicular)	32
Spill Out - House 14	
Table (E, Perpendicular)	33
Spill Out - House 15	
Table (E, Perpendicular)	34
Spill Out - House 16	
Table (E, Perpendicular)	35
Spill Out - House 17	
Table (E, Perpendicular)	36

MIDSTREAM LIGHTING LIMITED
 WESSEX HOUSE
 1 CHESHAM STREET
 LONDON, SW 1X 8ND, UNITED KINGDOM

Operator MIDSTREAM LIGHTING LIMITED
 Telephone +44 (0)207 584 8310
 Fax
 e-Mail info@midstreamlighting.com

Table of contents

Spill Out - House 18	
Table (E, Perpendicular)	37
Spill Out - House 19	
Table (E, Perpendicular)	38
Spill Out - House 20	
Table (E, Perpendicular)	39
Spill Out - House 21	
Table (E, Perpendicular)	40
Spill Out - House 22	
Table (E, Perpendicular)	41
Spill Out - House 23	
Table (E, Perpendicular)	42
Spill Out - House 24	
Table (E, Perpendicular)	43
Spill Out - House 25	
Table (E, Perpendicular)	44
Spill Out - House 26	
Table (E, Perpendicular)	45
Spill Out - House 27	
Table (E, Perpendicular)	46
Spill Out - House 28	
Table (E, Perpendicular)	47
Spill Out - House 29	
Table (E, Perpendicular)	48
Spill Out - House 30	
Table (E, Perpendicular)	49
Spill Out - House 31	
Table (E, Perpendicular)	50
Spill Out - House 32	
Table (E, Perpendicular)	51
Spill Out - House 33	
Table (E, Perpendicular)	52
Spill Out - House 34	
Table (E, Perpendicular)	53
Spill Out - House 35	
Table (E, Perpendicular)	54
Spill Out - House 36	
Table (E, Perpendicular)	55
Spill Out - House 37	
Table (E, Perpendicular)	56
Spill Out - House 38	
Table (E, Perpendicular)	57
Spill Out - House 39	
Table (E, Perpendicular)	58
Spill Out - House 40	
Table (E, Perpendicular)	59
Spill Out - House 41	
Table (E, Perpendicular)	60
Spill Out - House 42	
Table (E, Perpendicular)	61
Spill Out - House 43	
Table (E, Perpendicular)	62
ALL ON	
Planning data	63

MIDSTREAM LIGHTING LIMITED
 WESSEX HOUSE
 1 CHESHAM STREET
 LONDON, SW 1X 8ND, UNITED KINGDOM

Operator MIDSTREAM LIGHTING LIMITED
 Telephone +44 (0)207 584 8310
 Fax
 e-Mail info@midstreamlighting.com

Table of contents

Luminaire parts list	64
Luminaires (layout plan)	65
Luminaires (coordinates list)	66
Sport Luminaires (Coordinates List)	67
3D Rendering	69
False Colour Rendering	70
Exterior Surfaces	
Tennis 1 Calculation Grid (TPA)	
Summary	71
Value Chart (E, Horizontal)	72
Tennis 1 Calculation Grid (PPA)	
Summary	73
Value Chart (E, Horizontal)	74
Tennis 2 Calculation Grid (TPA)	
Summary	75
Value Chart (E, Horizontal)	76
Tennis 2 Calculation Grid (PPA)	
Summary	77
Value Chart (E, Horizontal)	78
Tennis 3 Calculation Grid (TPA)	
Summary	79
Value Chart (E, Horizontal)	80
Tennis 3 Calculation Grid (PPA)	
Summary	81
Value Chart (E, Horizontal)	82
Tennis 4 Calculation Grid (TPA)	
Summary	83
Value Chart (E, Horizontal)	84
Tennis 4 Calculation Grid (PPA)	
Summary	85
Value Chart (E, Horizontal)	86
Tennis 5 Calculation Grid (TPA)	
Summary	87
Value Chart (E, Horizontal)	88
Tennis 5 Calculation Grid (PPA)	
Summary	89
Value Chart (E, Horizontal)	90
Tennis 6 Calculation Grid (TPA)	
Summary	91
Value Chart (E, Horizontal)	92
Tennis 6 Calculation Grid (PPA)	
Summary	93
Value Chart (E, Horizontal)	94
Spill Out - House 1	
Table (E, Perpendicular)	95
Spill Out - House 2	
Table (E, Perpendicular)	96
Spill Out - House 3	
Table (E, Perpendicular)	97
Spill Out - House 4	
Table (E, Perpendicular)	98
Spill Out - House 5	
Table (E, Perpendicular)	99
Spill Out - House 6	

MIDSTREAM LIGHTING LIMITED
 WESSEX HOUSE
 1 CHESHAM STREET
 LONDON, SW 1X 8ND, UNITED KINGDOM

Operator MIDSTREAM LIGHTING LIMITED
 Telephone +44 (0)207 584 8310
 Fax
 e-Mail info@midstreamlighting.com

Table of contents

Table (E, Perpendicular)	100
Spill Out - House 7	
Table (E, Perpendicular)	101
Spill Out - House 8	
Table (E, Perpendicular)	102
Spill Out - House 9	
Table (E, Perpendicular)	103
Spill Out - House 10	
Table (E, Perpendicular)	104
Spill Out - House 11	
Table (E, Perpendicular)	105
Spill Out - House 12	
Table (E, Perpendicular)	106
Spill Out - House 13	
Table (E, Perpendicular)	107
Spill Out - House 14	
Table (E, Perpendicular)	108
Spill Out - House 15	
Table (E, Perpendicular)	109
Spill Out - House 16	
Table (E, Perpendicular)	110
Spill Out - House 17	
Table (E, Perpendicular)	111
Spill Out - House 18	
Table (E, Perpendicular)	112
Spill Out - House 19	
Table (E, Perpendicular)	113
Spill Out - House 20	
Table (E, Perpendicular)	114
Spill Out - House 21	
Table (E, Perpendicular)	115
Spill Out - House 22	
Table (E, Perpendicular)	116
Spill Out - House 23	
Table (E, Perpendicular)	117
Spill Out - House 24	
Table (E, Perpendicular)	118
Spill Out - House 25	
Table (E, Perpendicular)	119
Spill Out - House 26	
Table (E, Perpendicular)	120
Spill Out - House 27	
Table (E, Perpendicular)	121
Spill Out - House 28	
Table (E, Perpendicular)	122
Spill Out - House 29	
Table (E, Perpendicular)	123
Spill Out - House 30	
Table (E, Perpendicular)	124
Spill Out - House 31	
Table (E, Perpendicular)	125
Spill Out - House 32	
Table (E, Perpendicular)	126
Spill Out - House 33	

MIDSTREAM LIGHTING LIMITED
WESSEX HOUSE
1 CHESHAM STREET
LONDON, SW 1X 8ND, UNITED KINGDOM

Operator MIDSTREAM LIGHTING LIMITED
Telephone +44 (0)207 584 8310
Fax
e-Mail info@midstreamlighting.com

Table of contents

Table (E, Perpendicular)	127
Spill Out - House 34	
Table (E, Perpendicular)	128
Spill Out - House 35	
Table (E, Perpendicular)	129
Spill Out - House 36	
Table (E, Perpendicular)	130
Spill Out - House 37	
Table (E, Perpendicular)	131
Spill Out - House 38	
Table (E, Perpendicular)	132
Spill Out - House 39	
Table (E, Perpendicular)	133
Spill Out - House 40	
Table (E, Perpendicular)	134
Spill Out - House 41	
Table (E, Perpendicular)	135
Spill Out - House 42	
Table (E, Perpendicular)	136
Spill Out - House 43	
Table (E, Perpendicular)	137
GR Calculation	
GR Observer (Results Overview)	138

MIDSTREAM LIGHTING LIMITED
WESSEX HOUSE
1 CHESHAM STREET
LONDON, SW 1X 8ND, UNITED KINGDOM

Operator MIDSTREAM LIGHTING LIMITED
Telephone +44 (0)207 584 8310
Fax
e-Mail info@midstreamlighting.com

MIDSTREAM - Modus S1100 WS (5000K) / Luminaire Data Sheet

Luminous emittance 1:

See our luminaire catalog for an image of the luminaire.

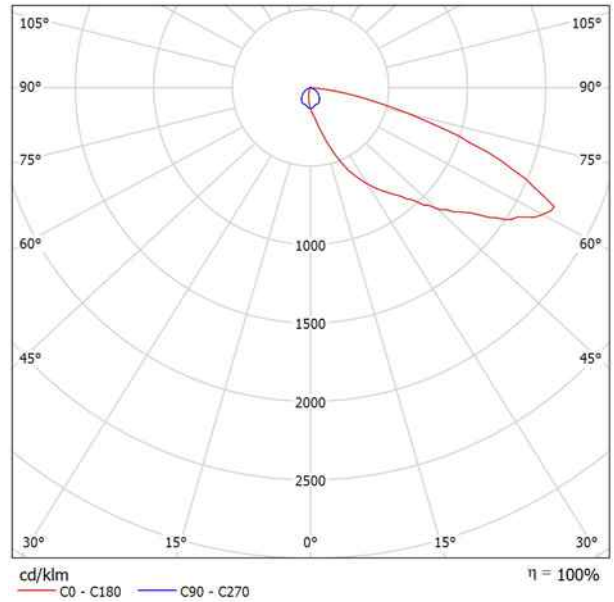

Luminaire classification according to CIE: 100
CIE flux code: 31 67 95 100 100

Due to missing symmetry properties, no UGR table can be displayed for this luminaire.

MIDSTREAM LIGHTING LIMITED
 WESSEX HOUSE
 1 CHESHAM STREET
 LONDON, SW 1X 8ND, UNITED KINGDOM

Operator MIDSTREAM LIGHTING LIMITED
 Telephone +44 (0)207 584 8310
 Fax
 e-Mail info@midstreamlighting.com

Only Retrofits ON / Planning data

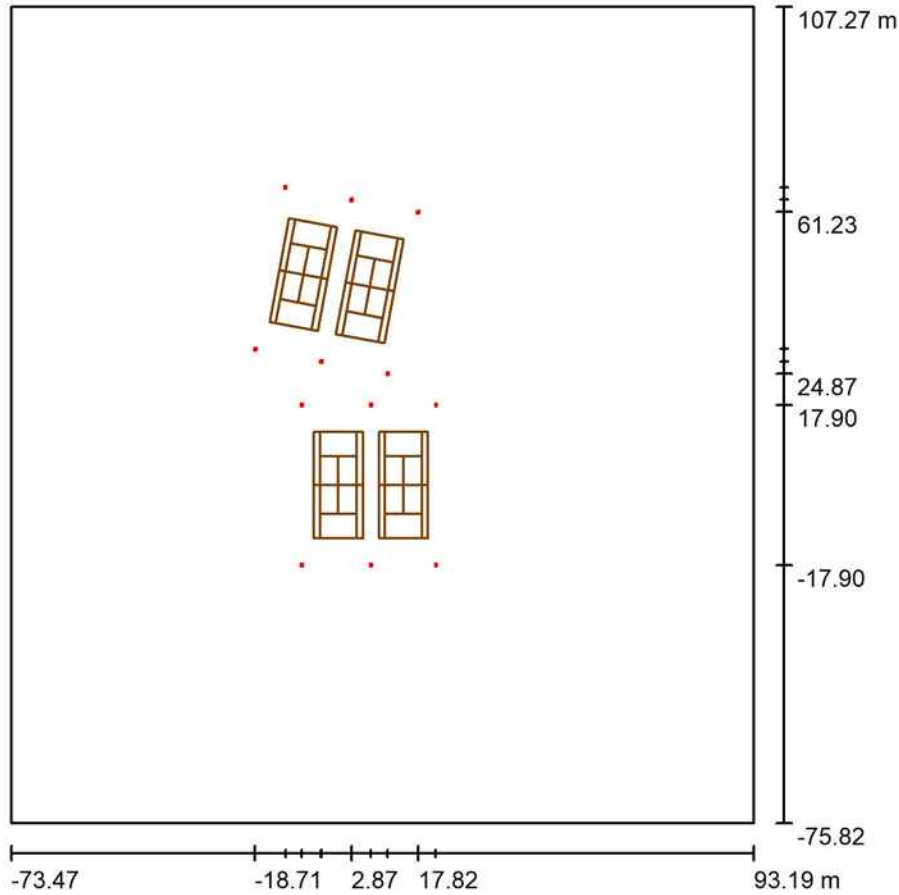

Maintenance factor: 0.90, ULR (Upward Light Ratio): 0.5%

Scale 1:1697

Luminaire Parts List

No.	Pieces	Designation (Correction Factor)	Φ (Luminaire) [lm]	Φ (Lamps) [lm]	P [W]
1	16	MIDSTREAM - Modus S1100 WS (5000K) (1.000)	135501	135500	1180.0
Total:			2168014	Total: 2168000	18880.0

MIDSTREAM LIGHTING LIMITED
WESSEX HOUSE
1 CHESHAM STREET
LONDON, SW 1X 8ND, UNITED KINGDOM

Operator MIDSTREAM LIGHTING LIMITED
Telephone +44 (0)207 584 8310
Fax
e-Mail info@midstreamlighting.com

Only Retrofits ON / Luminaire parts list

16 Pieces MIDSTREAM - Modus S1100 WS (5000K)
Article No.:
Luminous flux (Luminaire): 135501 lm
Luminous flux (Lamps): 135500 lm
Luminaire Wattage: 1180.0 W
Luminaire classification according to CIE: 100
CIE flux code: 31 67 95 100 100
Fitting: 1 x LED (Correction Factor 1.000).

See our luminaire catalog
for an image of the
luminaire.

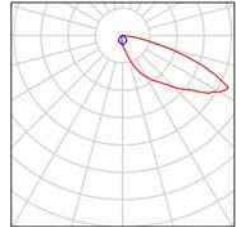

MIDSTREAM LIGHTING LIMITED
 WESSEX HOUSE
 1 CHESHAM STREET
 LONDON, SW 1X 8ND, UNITED KINGDOM

Operator MIDSTREAM LIGHTING LIMITED
 Telephone +44 (0)207 584 8310
 Fax
 e-Mail info@midstreamlighting.com

Only Retrofits ON / Luminaires (layout plan)

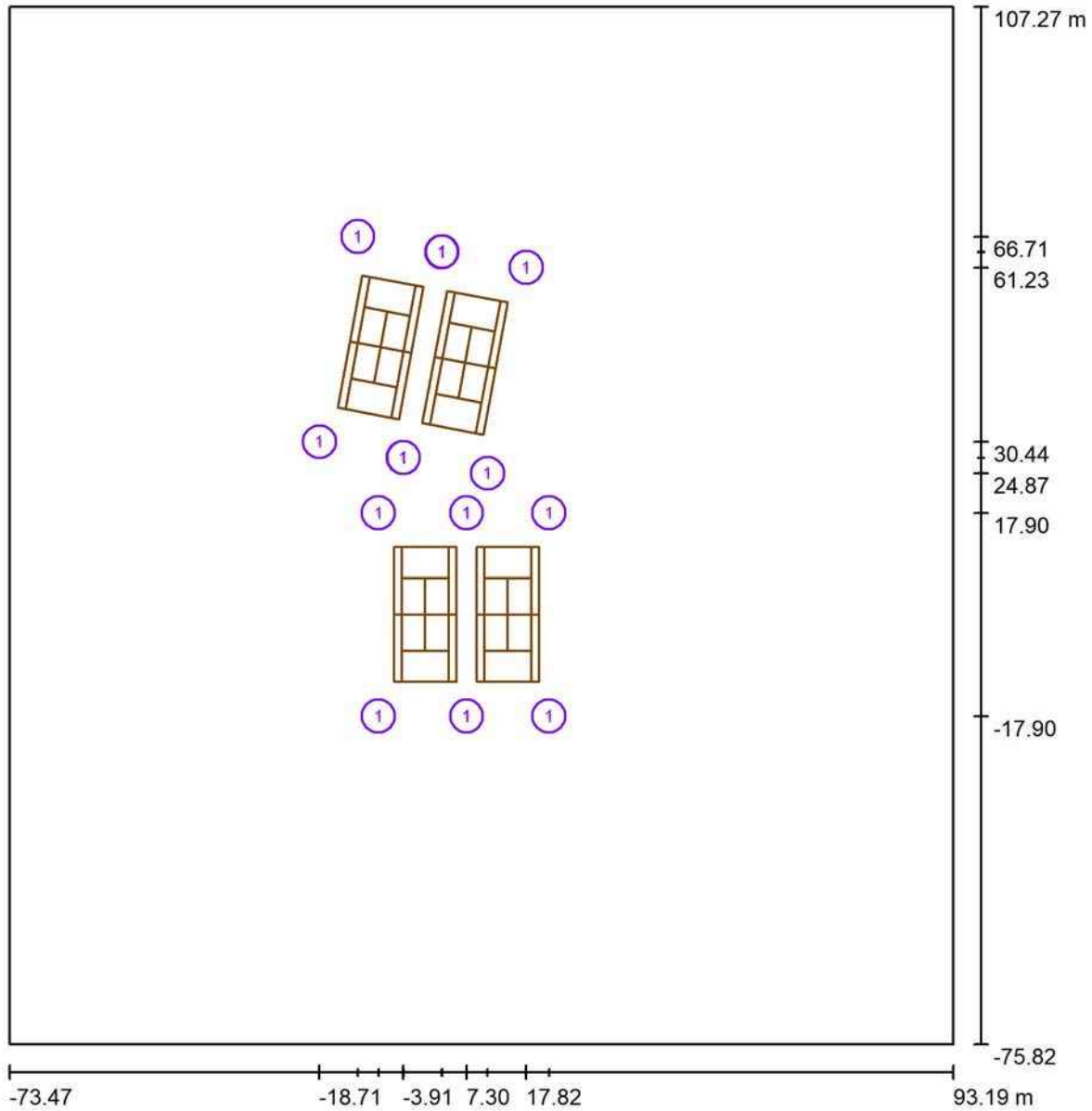

Scale 1 : 1239

Luminaire Parts List

No.	Pieces	Designation
1	16	MIDSTREAM - Modus S1100 WS (5000K)

MIDSTREAM LIGHTING LIMITED
 WESSEX HOUSE
 1 CHESHAM STREET
 LONDON, SW 1X 8ND, UNITED KINGDOM

Operator MIDSTREAM LIGHTING LIMITED
 Telephone +44 (0)207 584 8310
 Fax
 e-Mail info@midstreamlighting.com

Only Retrofits ON / Luminaires (coordinates list)

MIDSTREAM - Modus S1100 WS (5000K)

135501 lm, 1180.0 W, 1 x 1 x LED (Correction Factor 1.000).

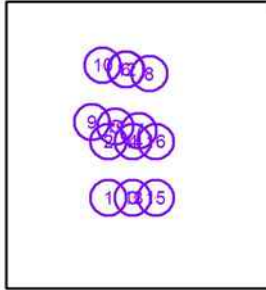

No.	Position [m]			Rotation [°]		
	X	Y	Z	X	Y	Z
1	-8.300	-17.900	8.500	0.0	-1.7	71.4
2	-8.300	17.901	8.500	0.0	-1.7	-71.4
3	7.300	-17.900	8.500	0.0	-1.5	106.8
4	7.300	17.901	8.500	0.0	-1.5	-106.8
5	-3.823	27.645	8.500	0.0	-2.1	64.7
6	2.981	64.004	8.500	0.0	-2.1	-85.9
7	11.015	24.868	8.500	0.0	-2.1	94.1
8	17.819	61.227	8.500	0.0	-2.1	-115.3
9	-18.712	30.439	8.500	0.0	-1.9	64.8
10	-11.924	66.708	8.500	0.0	-1.9	-86.0
11	-3.914	27.670	8.500	0.0	-1.9	94.0
12	2.874	63.939	8.500	0.0	-1.9	-115.2
13	7.300	-17.900	8.500	0.0	-1.4	74.5
14	7.300	17.901	8.500	0.0	-1.4	-74.5
15	21.840	-17.900	8.500	0.0	-1.4	105.5
16	21.840	17.901	8.500	0.0	-1.4	-105.5

MIDSTREAM LIGHTING LIMITED
 WESSEX HOUSE
 1 CHESHAM STREET
 LONDON, SW 1X 8ND, UNITED KINGDOM

Operator MIDSTREAM LIGHTING LIMITED
 Telephone +44 (0)207 584 8310
 Fax
 e-Mail info@midstreamlighting.com

Only Retrofits ON / Sport Luminaires (Coordinates List)

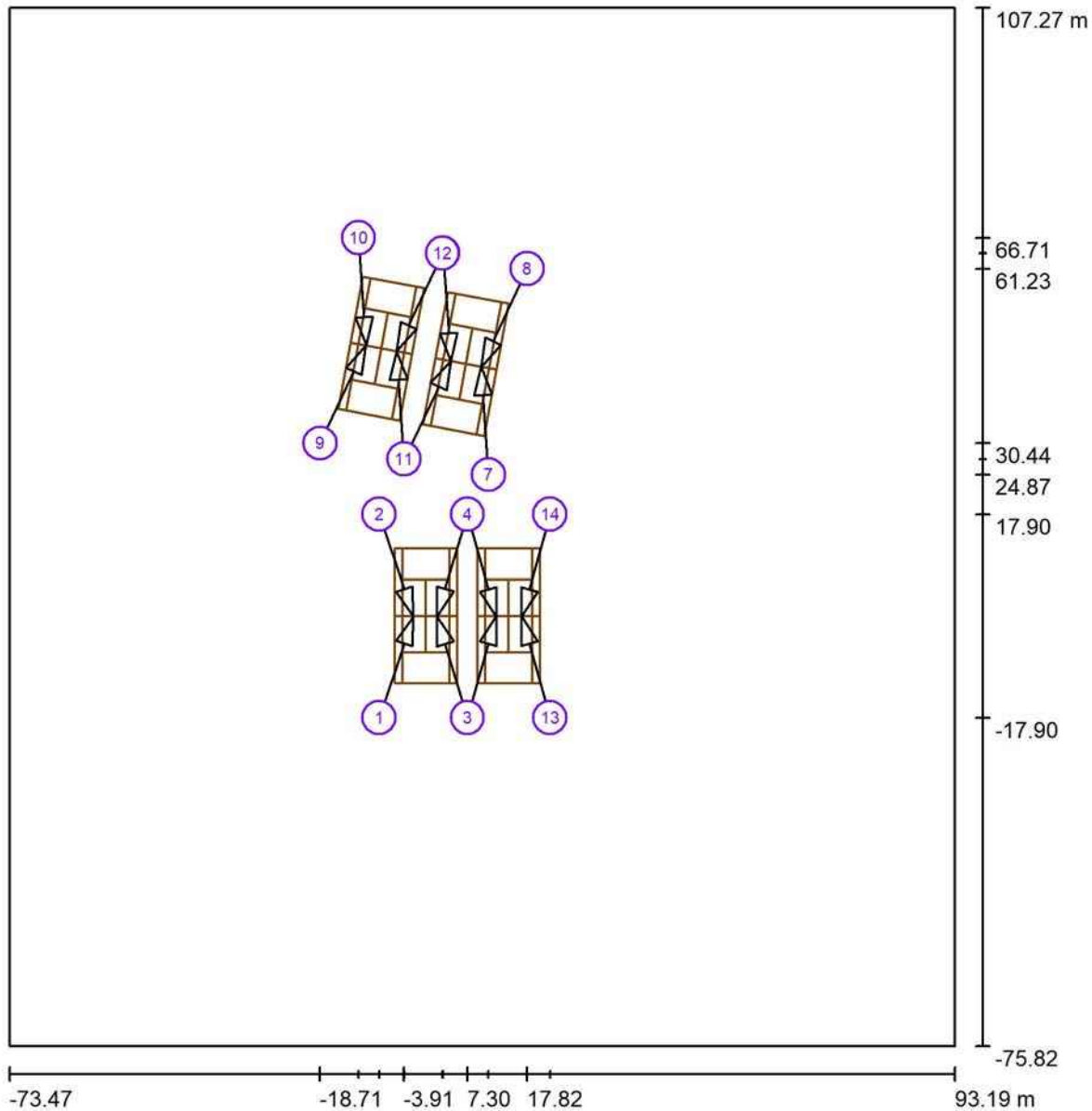

Scale 1 : 1239

List of the Sport Luminaires

Luminaire	Index	Position [m]			Aiming Point [m]			Angle [°]	Alignment	Pole
		X	Y	Z	X	Y	Z			
MIDSTREAM - Modus S1100 WS (5000K)	1	-8.300	-17.900	8.500	-2.292	-0.044	0.000	24.3	(C IMax, G IMax)	/
MIDSTREAM - Modus S1100 WS (5000K)	2	-8.300	17.901	8.500	-2.292	0.045	0.000	24.3	(C IMax, G IMax)	/
MIDSTREAM - Modus S1100 WS (5000K)	3	7.300	-17.900	8.500	1.898	-0.047	0.000	24.5	(C IMax, G IMax)	/
MIDSTREAM - Modus S1100 WS (5000K)	4	7.300	17.901	8.500	1.898	0.048	0.000	24.5	(C IMax, G IMax)	/

MIDSTREAM LIGHTING LIMITED
 WESSEX HOUSE
 1 CHESHAM STREET
 LONDON, SW 1X 8ND, UNITED KINGDOM

Operator MIDSTREAM LIGHTING LIMITED
 Telephone +44 (0)207 584 8310
 Fax
 e-Mail info@midstreamlighting.com

Only Retrofits ON / Sport Luminaires (Coordinates List)

List of the Sport Luminaires

Luminaire	Index	Position [m]			Aiming Point [m]			Angle [°]	Alignment	Pole
		X	Y	Z	X	Y	Z			
MIDSTREAM - Modus S1100 WS (5000K)	5	-3.823	27.645	8.500	4.353	44.968	0.000	23.9	(C IMax, G IMax)	/
MIDSTREAM - Modus S1100 WS (5000K)	6	2.981	64.004	8.500	4.340	44.897	0.000	23.9	(C IMax, G IMax)	/
MIDSTREAM - Modus S1100 WS (5000K)	7	11.015	24.868	8.500	9.656	43.975	0.000	23.9	(C IMax, G IMax)	/
MIDSTREAM - Modus S1100 WS (5000K)	8	17.819	61.227	8.500	9.643	43.904	0.000	23.9	(C IMax, G IMax)	/
MIDSTREAM - Modus S1100 WS (5000K)	9	-18.712	30.439	8.500	-10.609	47.657	0.000	24.1	(C IMax, G IMax)	/
MIDSTREAM - Modus S1100 WS (5000K)	10	-11.924	66.708	8.500	-10.596	47.725	0.000	24.1	(C IMax, G IMax)	/
MIDSTREAM - Modus S1100 WS (5000K)	11	-3.914	27.670	8.500	-5.242	46.653	0.000	24.1	(C IMax, G IMax)	/
MIDSTREAM - Modus S1100 WS (5000K)	12	2.874	63.939	8.500	-5.229	46.721	0.000	24.1	(C IMax, G IMax)	/
MIDSTREAM - Modus S1100 WS (5000K)	3	7.300	-17.900	8.500	12.271	0.022	0.000	24.6	(C IMax, G IMax)	/
MIDSTREAM - Modus S1100 WS (5000K)	4	7.300	17.901	8.500	12.271	-0.021	0.000	24.6	(C IMax, G IMax)	/
MIDSTREAM - Modus S1100 WS (5000K)	13	21.840	-17.900	8.500	16.869	0.022	0.000	24.6	(C IMax, G IMax)	/
MIDSTREAM - Modus S1100 WS (5000K)	14	21.840	17.901	8.500	16.869	-0.021	0.000	24.6	(C IMax, G IMax)	/

MIDSTREAM LIGHTING LIMITED
WESSEX HOUSE
1 CHESHAM STREET
LONDON, SW 1X 8ND, UNITED KINGDOM

Operator MIDSTREAM LIGHTING LIMITED
Telephone +44 (0)207 584 8310
Fax
e-Mail info@midstreamlighting.com

Only Retrofits ON / 3D Rendering

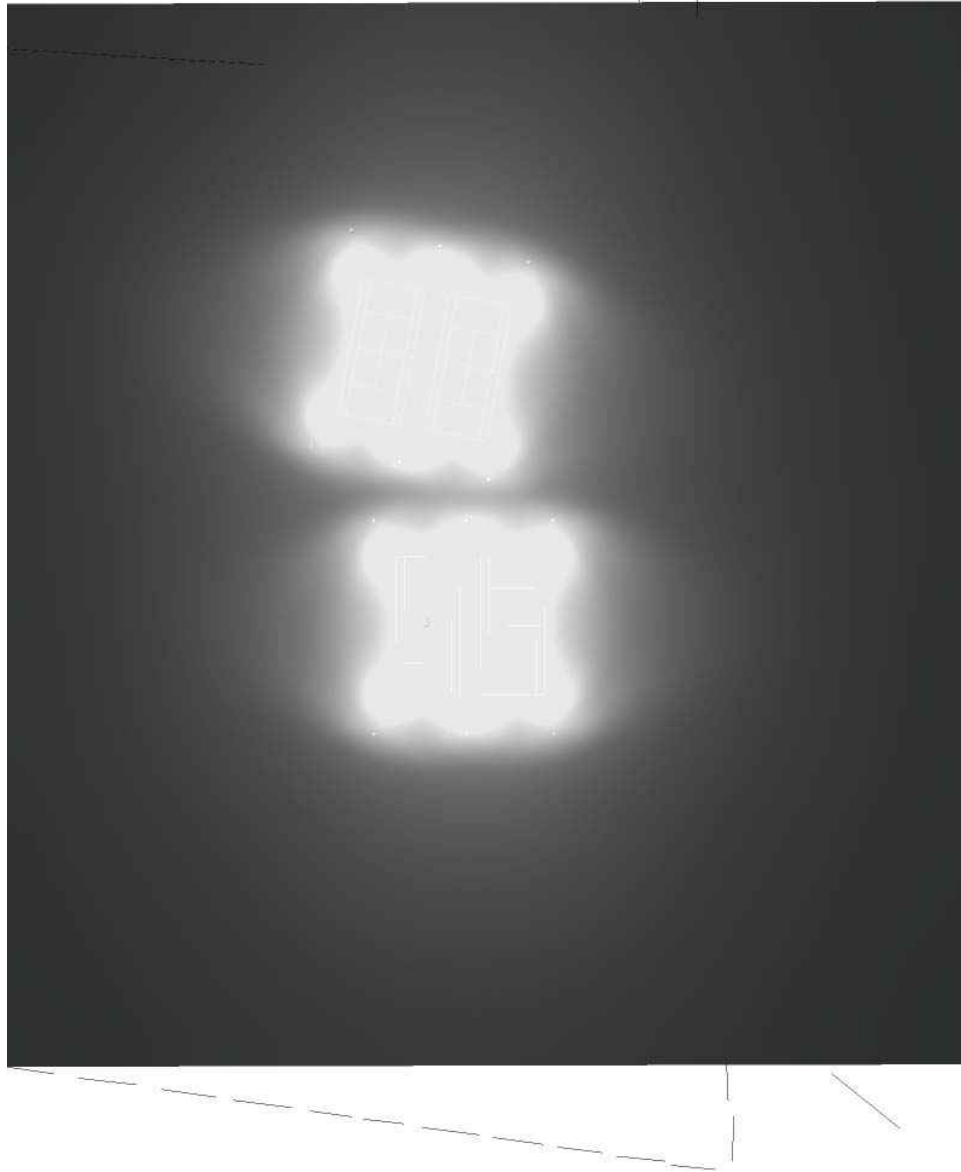

MIDSTREAM LIGHTING LIMITED
WESSEX HOUSE
1 CHESHAM STREET
LONDON, SW 1X 8ND, UNITED KINGDOM

Operator MIDSTREAM LIGHTING LIMITED
Telephone +44 (0)207 584 8310
Fax
e-Mail info@midstreamlighting.com

Only Retrofits ON / False Colour Rendering

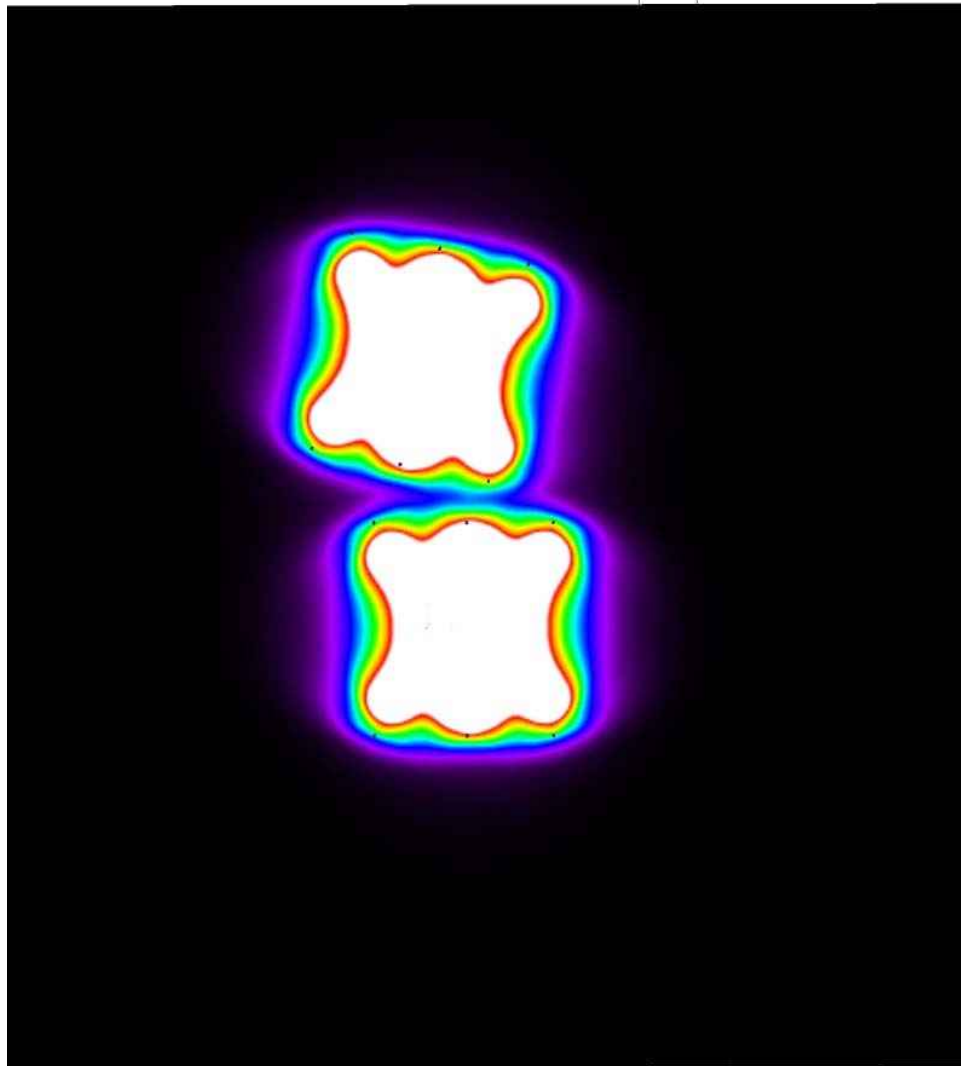

3.01

58.88

114.76

170.63

226.50

282.38

338.25

394.13

450

lx



MIDSTREAM LIGHTING LIMITED
 WESSEX HOUSE
 1 CHESHAM STREET
 LONDON, SW 1X 8ND, UNITED KINGDOM

Operator MIDSTREAM LIGHTING LIMITED
 Telephone +44 (0)207 584 8310
 Fax
 e-Mail info@midstreamlighting.com

Only Retrofits ON / Tennis 1 Calculation Grid (TPA) / Summary

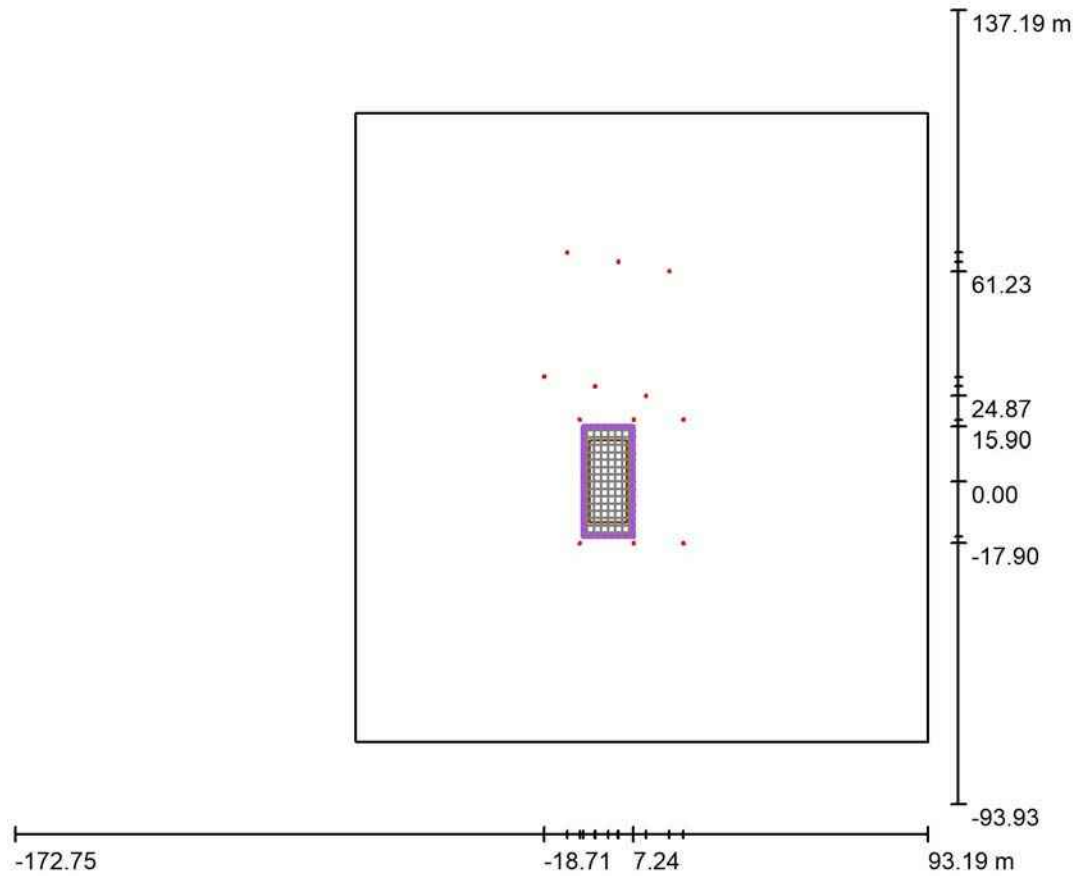

Scale 1 : 2204

Position: (-0.010 m, 0.000 m, 0.000 m)
 Size: (31.800 m, 14.500 m)
 Rotation: (0.0°, 0.0°, 90.0°)
 Type: Normal, Grid: 15 x 7 Points
 Belongs to the following sport arena: Tennis 1

Results overview

No.	Type	E_{av} [lx]	E_{min} [lx]	E_{max} [lx]	$u0$	E_{min} / E_{max}	$E_{h\ m} / E_m$	H [m]	Camera
1	horizontal	730	416	1482	0.57	0.28	/	0.000	/

$E_{h\ m} / E_m$ = Relationship between middle horizontal and vertical illuminance, H = Measuring Height

MIDSTREAM LIGHTING LIMITED
 WESSEX HOUSE
 1 CHESHAM STREET
 LONDON, SW 1X 8ND, UNITED KINGDOM

Operator MIDSTREAM LIGHTING LIMITED
 Telephone +44 (0)207 584 8310
 Fax
 e-Mail info@midstreamlighting.com

Only Retrofits ON / Tennis 1 Calculation Grid (TPA) / Value Chart (E, Horizontal)

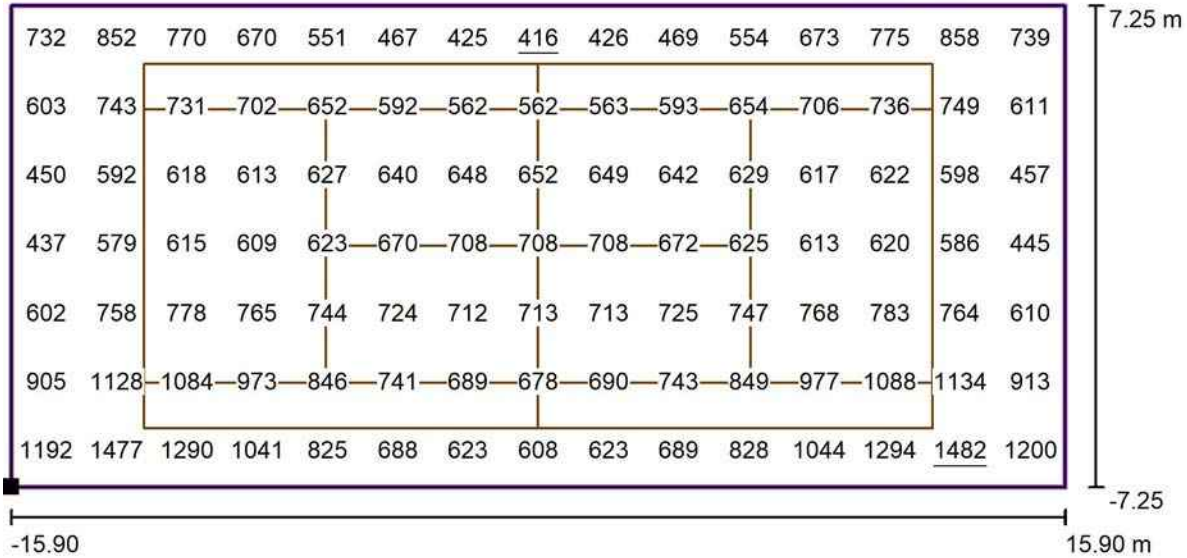

Values in Lux, Scale 1 : 228

Position of surface in external scene:
 Marked point: (7.240 m, -15.900 m,
 0.000 m)



Grid: 15 x 7 Points

E_{av} [lx]	E_{min} [lx]	E_{max} [lx]	u0	E_{min} / E_{max}
730	416	1482	0.57	0.28

MIDSTREAM LIGHTING LIMITED
 WESSEX HOUSE
 1 CHESHAM STREET
 LONDON, SW 1X 8ND, UNITED KINGDOM

Operator MIDSTREAM LIGHTING LIMITED
 Telephone +44 (0)207 584 8310
 Fax
 e-Mail info@midstreamlighting.com

Only Retrofits ON / Tennis 1 Calculation Grid (PPA) / Summary

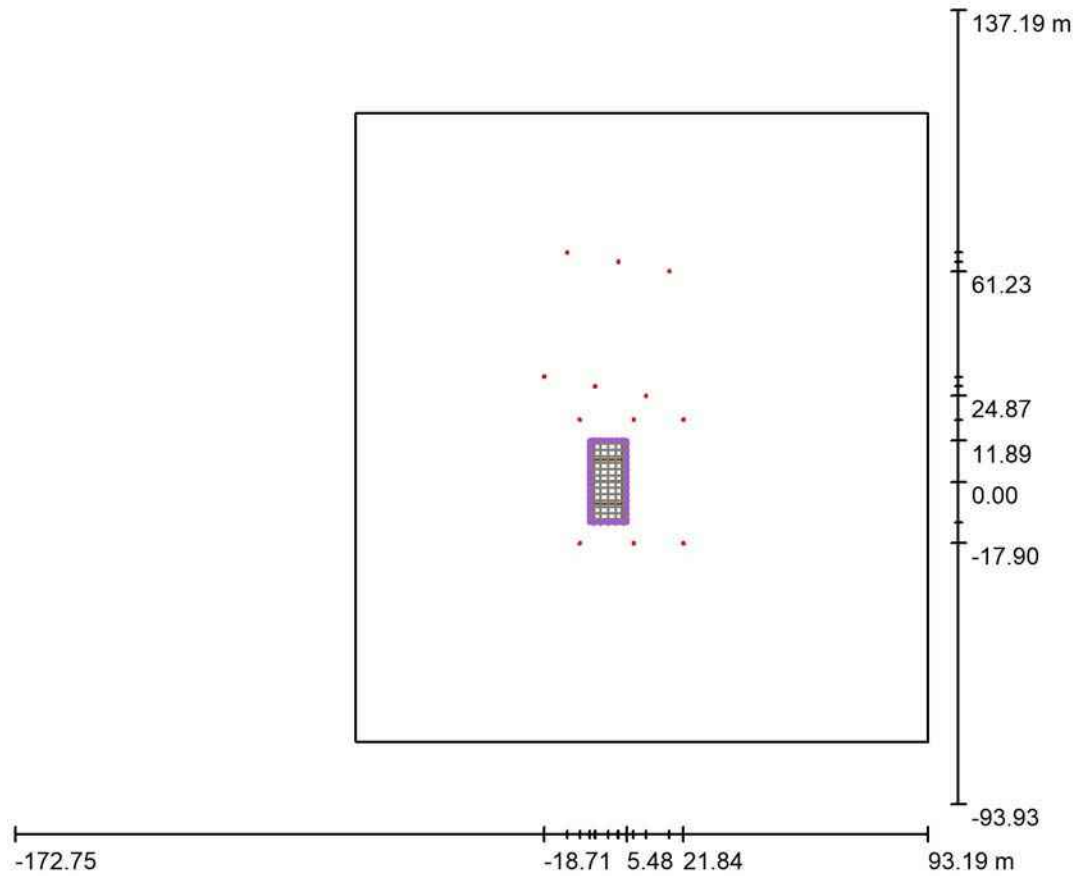

Scale 1 : 2204

Position: (0.000 m, 0.000 m, 0.000 m)
 Size: (23.780 m, 10.970 m)
 Rotation: (0.0°, 0.0°, 90.0°)
 Type: Normal, Grid: 13 x 5 Points
 Belongs to the following sport arena: Tennis 1

Results overview

No.	Type	E_{av} [lx]	E_{min} [lx]	E_{max} [lx]	u0	E_{min} / E_{max}	$E_{h\ m} / E_m$	H [m]	Camera
1	horizontal	708	547	1143	0.77	0.48	/	0.000	/

$E_{h\ m} / E_m$ = Relationship between middle horizontal and vertical illuminance, H = Measuring Height

MIDSTREAM LIGHTING LIMITED
 WESSEX HOUSE
 1 CHESHAM STREET
 LONDON, SW 1X 8ND, UNITED KINGDOM

Operator MIDSTREAM LIGHTING LIMITED
 Telephone +44 (0)207 584 8310
 Fax
 e-Mail info@midstreamlighting.com

Only Retrofits ON / Tennis 1 Calculation Grid (PPA) / Value Chart (E, Horizontal)

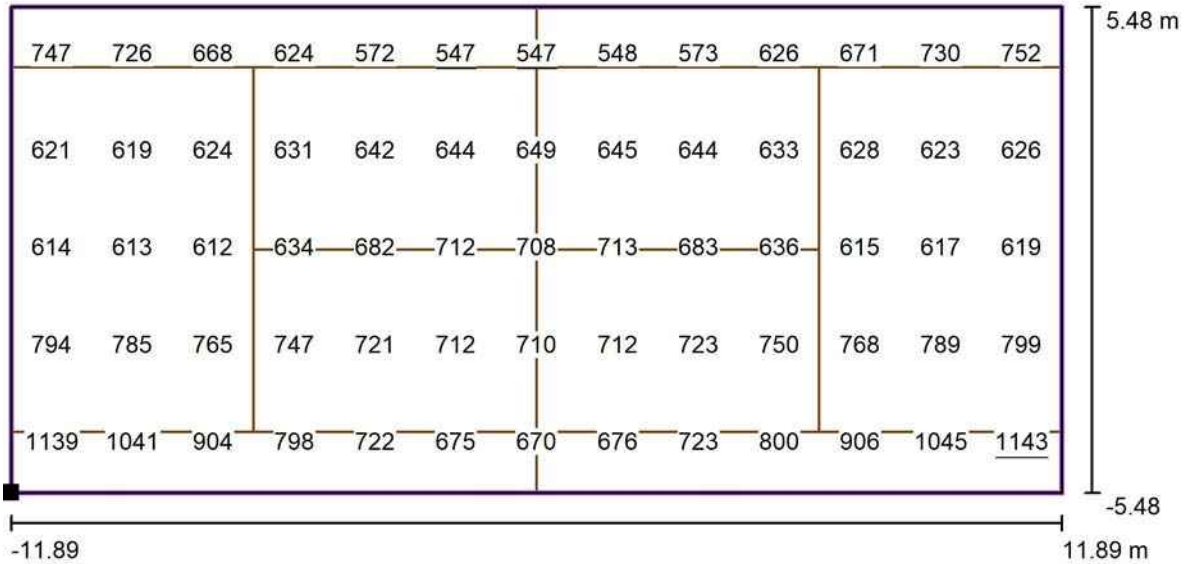

Values in Lux, Scale 1 : 171

Position of surface in external scene:
 Marked point: (5.485 m, -11.890 m,
 0.000 m)



Grid: 13 x 5 Points

E_{av} [lx]
708

E_{min} [lx]
547

E_{max} [lx]
1143

u_0
0.77

E_{min} / E_{max}
0.48

MIDSTREAM LIGHTING LIMITED
 WESSEX HOUSE
 1 CHESHAM STREET
 LONDON, SW 1X 8ND, UNITED KINGDOM

Operator MIDSTREAM LIGHTING LIMITED
 Telephone +44 (0)207 584 8310
 Fax
 e-Mail info@midstreamlighting.com

Only Retrofits ON / Spill Out - House 1 / Table (E, Perpendicular)



Position of surface in external scene:
 Marked point: (34.061 m, 137.195 m,
 0.000 m)

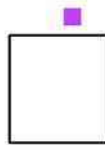

1.000 1.09

0.000 1.27

m 5.000

Attention: The coordinates refer to the image above. Values in Lux.

Grid: 1 x 2 Points

E_{av} [lx]
1.18

E_{min} [lx]
1.09

E_{max} [lx]
1.27

$u0$
0.93

E_{min} / E_{max}
0.86

MIDSTREAM LIGHTING LIMITED
 WESSEX HOUSE
 1 CHESHAM STREET
 LONDON, SW 1X 8ND, UNITED KINGDOM

Operator MIDSTREAM LIGHTING LIMITED
 Telephone +44 (0)207 584 8310
 Fax
 e-Mail info@midstreamlighting.com

Only Retrofits ON / Spill Out - House 2 / Table (E, Perpendicular)



Position of surface in external scene:
 Marked point: (36.721 m, 108.534 m,
 0.000 m)

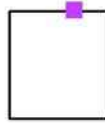

1.000 3.15

0.000 3.43

m 5.000

Attention: The coordinates refer to the image above. Values in Lux.

Grid: 1 x 2 Points

E_{av} [lx]
3.29

E_{min} [lx]
3.15

E_{max} [lx]
3.43

$u0$
0.96

E_{min} / E_{max}
0.92

MIDSTREAM LIGHTING LIMITED
 WESSEX HOUSE
 1 CHESHAM STREET
 LONDON, SW 1X 8ND, UNITED KINGDOM

Operator MIDSTREAM LIGHTING LIMITED
 Telephone +44 (0)207 584 8310
 Fax
 e-Mail info@midstreamlighting.com

Only Retrofits ON / Spill Out - House 3 / Table (E, Perpendicular)



Position of surface in external scene:
 Marked point: (37.913 m, 92.603 m,
 0.000 m)

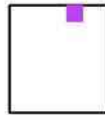

1.000 5.49

0.000 5.95

m **4.000**

Attention: The coordinates refer to the image above. Values in Lux.

Grid: 1 x 2 Points

E_{av} [lx]
5.72

E_{min} [lx]
5.49

E_{max} [lx]
5.95

u_0
0.96

E_{min} / E_{max}
0.92

MIDSTREAM LIGHTING LIMITED
 WESSEX HOUSE
 1 CHESHAM STREET
 LONDON, SW 1X 8ND, UNITED KINGDOM

Operator MIDSTREAM LIGHTING LIMITED
 Telephone +44 (0)207 584 8310
 Fax
 e-Mail info@midstreamlighting.com

Only Retrofits ON / Spill Out - House 4 / Table (E, Perpendicular)



Position of surface in external scene:
 Marked point: (38.283 m, 82.245 m,
 0.000 m)



1.000 8.16

0.000 8.37

m 5.000

Attention: The coordinates refer to the image above. Values in Lux.

Grid: 1 x 2 Points

E_{av} [lx]
8.26

E_{min} [lx]
8.16

E_{max} [lx]
8.37

u_0
0.99

E_{min} / E_{max}
0.97

MIDSTREAM LIGHTING LIMITED
 WESSEX HOUSE
 1 CHESHAM STREET
 LONDON, SW 1X 8ND, UNITED KINGDOM

Operator MIDSTREAM LIGHTING LIMITED
 Telephone +44 (0)207 584 8310
 Fax
 e-Mail info@midstreamlighting.com

Only Retrofits ON / Spill Out - House 5 / Table (E, Perpendicular)



Position of surface in external scene:
 Marked point: (37.686 m, 69.706 m,
 0.000 m)

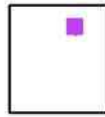

1.000 13
0.000 13
 m **5.000**

Attention: The coordinates refer to the image above. Values in Lux.

Grid: 1 x 2 Points

E_{av} [lx]	E_{min} [lx]	E_{max} [lx]	$u0$	E_{min} / E_{max}
13	13	13	0.99	0.98

MIDSTREAM LIGHTING LIMITED
 WESSEX HOUSE
 1 CHESHAM STREET
 LONDON, SW 1X 8ND, UNITED KINGDOM

Operator MIDSTREAM LIGHTING LIMITED
 Telephone +44 (0)207 584 8310
 Fax
 e-Mail info@midstreamlighting.com

Only Retrofits ON / Spill Out - House 6 / Table (E, Perpendicular)



Position of surface in external scene:
 Marked point: (38.898 m, 55.448 m,
 0.000 m)



1.000 20

0.000 20

m 4.000

Attention: The coordinates refer to the image above. Values in Lux.

Grid: 1 x 2 Points

E_{av} [lx]	E_{min} [lx]	E_{max} [lx]	u0	E_{min} / E_{max}
20	20	20	0.99	0.98

MIDSTREAM LIGHTING LIMITED
 WESSEX HOUSE
 1 CHESHAM STREET
 LONDON, SW 1X 8ND, UNITED KINGDOM

Operator MIDSTREAM LIGHTING LIMITED
 Telephone +44 (0)207 584 8310
 Fax
 e-Mail info@midstreamlighting.com

Only Retrofits ON / Spill Out - House 7 / Table (E, Perpendicular)



Position of surface in external scene:
 Marked point: (38.898 m, 44.103 m,
 0.000 m)



1.000 23

0.000 23

m 4.000

Attention: The coordinates refer to the image above. Values in Lux.

Grid: 1 x 2 Points

E_{av} [lx]	E_{min} [lx]	E_{max} [lx]	u0	E_{min} / E_{max}
23	23	23	0.98	0.97

MIDSTREAM LIGHTING LIMITED
 WESSEX HOUSE
 1 CHESHAM STREET
 LONDON, SW 1X 8ND, UNITED KINGDOM

Operator MIDSTREAM LIGHTING LIMITED
 Telephone +44 (0)207 584 8310
 Fax
 e-Mail info@midstreamlighting.com

Only Retrofits ON / Spill Out - House 8 / Table (E, Perpendicular)



Position of surface in external scene:
 Marked point: (39.495 m, 31.565 m,
 0.000 m)



1.000 20

0.000 19

m 4.000

Attention: The coordinates refer to the image above. Values in Lux.

Grid: 1 x 2 Points

E_{av} [lx]
20

E_{min} [lx]
19

E_{max} [lx]
20

u_0
0.98

E_{min} / E_{max}
0.95

MIDSTREAM LIGHTING LIMITED
 WESSEX HOUSE
 1 CHESHAM STREET
 LONDON, SW 1X 8ND, UNITED KINGDOM

Operator MIDSTREAM LIGHTING LIMITED
 Telephone +44 (0)207 584 8310
 Fax
 e-Mail info@midstreamlighting.com

Only Retrofits ON / Spill Out - House 9 / Table (E, Perpendicular)



Position of surface in external scene:
 Marked point: (41.592 m, 20.240 m,
 0.000 m)

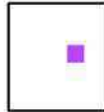

1.000 22

0.000 20

m 4.500

Attention: The coordinates refer to the image above. Values in Lux.

Grid: 1 x 2 Points

E_{av} [lx]	E_{min} [lx]	E_{max} [lx]	u0	E_{min} / E_{max}
21	20	22	0.96	0.92

MIDSTREAM LIGHTING LIMITED
 WESSEX HOUSE
 1 CHESHAM STREET
 LONDON, SW 1X 8ND, UNITED KINGDOM

Operator MIDSTREAM LIGHTING LIMITED
 Telephone +44 (0)207 584 8310
 Fax
 e-Mail info@midstreamlighting.com

Only Retrofits ON / Spill Out - House 10 / Table (E, Perpendicular)



Position of surface in external scene:
 Marked point: (43.316 m, 7.562 m,
 0.000 m)

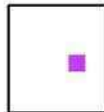

1.000 26

0.000 25

m 4.000

Attention: The coordinates refer to the image above. Values in Lux.

Grid: 1 x 2 Points

E_{av} [lx]	E_{min} [lx]	E_{max} [lx]	u0	E_{min} / E_{max}
25	25	26	0.98	0.95

MIDSTREAM LIGHTING LIMITED
 WESSEX HOUSE
 1 CHESHAM STREET
 LONDON, SW 1X 8ND, UNITED KINGDOM

Operator MIDSTREAM LIGHTING LIMITED
 Telephone +44 (0)207 584 8310
 Fax
 e-Mail info@midstreamlighting.com

Only Retrofits ON / Spill Out - House 11 / Table (E, Perpendicular)



Position of surface in external scene:
 Marked point: (44.417 m, -3.158 m,
 0.000 m)

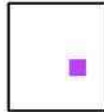

1.000 21

0.000 20

m 4.500

Attention: The coordinates refer to the image above. Values in Lux.

Grid: 1 x 2 Points

E_{av} [lx]	E_{min} [lx]	E_{max} [lx]	$u0$	E_{min} / E_{max}
20	20	21	0.98	0.97

MIDSTREAM LIGHTING LIMITED
 WESSEX HOUSE
 1 CHESHAM STREET
 LONDON, SW 1X 8ND, UNITED KINGDOM

Operator MIDSTREAM LIGHTING LIMITED
 Telephone +44 (0)207 584 8310
 Fax
 e-Mail info@midstreamlighting.com

Only Retrofits ON / Spill Out - House 12 / Table (E, Perpendicular)



Position of surface in external scene:
 Marked point: (46.352 m, -15.281 m,
 0.000 m)

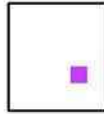

1.000 9.37

0.000 8.86

m **3.500**

Attention: The coordinates refer to the image above. Values in Lux.

Grid: 1 x 2 Points

E_{av} [lx]
9.12

E_{min} [lx]
8.86

E_{max} [lx]
9.37

u0
0.97

E_{min} / E_{max}
0.95

MIDSTREAM LIGHTING LIMITED
 WESSEX HOUSE
 1 CHESHAM STREET
 LONDON, SW 1X 8ND, UNITED KINGDOM

Operator MIDSTREAM LIGHTING LIMITED
 Telephone +44 (0)207 584 8310
 Fax
 e-Mail info@midstreamlighting.com

Only Retrofits ON / Spill Out - House 13 / Table (E, Perpendicular)



Position of surface in external scene:
 Marked point: (47.070 m, -25.177 m,
 0.000 m)

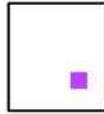

1.000 5.61

0.000 5.41

m 3.500

Attention: The coordinates refer to the image above. Values in Lux.

Grid: 1 x 2 Points

E_{av} [lx]	E_{min} [lx]	E_{max} [lx]	u0	E_{min} / E_{max}
5.51	5.41	5.61	0.98	0.96

MIDSTREAM LIGHTING LIMITED
 WESSEX HOUSE
 1 CHESHAM STREET
 LONDON, SW 1X 8ND, UNITED KINGDOM

Operator MIDSTREAM LIGHTING LIMITED
 Telephone +44 (0)207 584 8310
 Fax
 e-Mail info@midstreamlighting.com

Only Retrofits ON / Spill Out - House 14 / Table (E, Perpendicular)



Position of surface in external scene:
 Marked point: (48.212 m, -35.069 m,
 0.000 m)



1.000 3.29

0.000 3.30

m 4.000

Attention: The coordinates refer to the image above. Values in Lux.

Grid: 1 x 2 Points

E_{av} [lx]
3.30

E_{min} [lx]
3.29

E_{max} [lx]
3.30

u_0
1.00

E_{min} / E_{max}
1.00

MIDSTREAM LIGHTING LIMITED
 WESSEX HOUSE
 1 CHESHAM STREET
 LONDON, SW 1X 8ND, UNITED KINGDOM

Operator MIDSTREAM LIGHTING LIMITED
 Telephone +44 (0)207 584 8310
 Fax
 e-Mail info@midstreamlighting.com

Only Retrofits ON / Spill Out - House 15 / Table (E, Perpendicular)



Position of surface in external scene:
 Marked point: (49.630 m, -45.019 m,
 0.000 m)

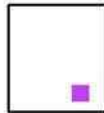

1.000 2.29

0.000 2.31

m **3.000**

Attention: The coordinates refer to the image above. Values in Lux.

Grid: 1 x 2 Points

E_{av} [lx]	E_{min} [lx]	E_{max} [lx]	$u0$	E_{min} / E_{max}
2.30	2.29	2.31	0.99	0.99

MIDSTREAM LIGHTING LIMITED
 WESSEX HOUSE
 1 CHESHAM STREET
 LONDON, SW 1X 8ND, UNITED KINGDOM

Operator MIDSTREAM LIGHTING LIMITED
 Telephone +44 (0)207 584 8310
 Fax
 e-Mail info@midstreamlighting.com

Only Retrofits ON / Spill Out - House 16 / Table (E, Perpendicular)



Position of surface in external scene:
 Marked point: (50.533 m, -59.881 m,
 0.000 m)

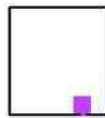

1.000 1.32

0.000 1.42

m 7.000

Attention: The coordinates refer to the image above. Values in Lux.

Grid: 1 x 2 Points

E_{av} [lx]	E_{min} [lx]	E_{max} [lx]	u0	E_{min} / E_{max}
1.37	1.32	1.42	0.97	0.93

MIDSTREAM LIGHTING LIMITED
 WESSEX HOUSE
 1 CHESHAM STREET
 LONDON, SW 1X 8ND, UNITED KINGDOM

Operator MIDSTREAM LIGHTING LIMITED
 Telephone +44 (0)207 584 8310
 Fax
 e-Mail info@midstreamlighting.com

Only Retrofits ON / Spill Out - House 17 / Table (E, Perpendicular)



Position of surface in external scene:
 Marked point: (52.332 m, -85.105 m,
 0.000 m)

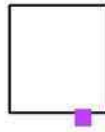

1.000 0.68

0.000 0.81

m 3.500

Attention: The coordinates refer to the image above. Values in Lux.

Grid: 1 x 2 Points

E_{av} [lx]
0.74

E_{min} [lx]
0.68

E_{max} [lx]
0.81

u0
0.91

E_{min} / E_{max}
0.83

MIDSTREAM LIGHTING LIMITED
 WESSEX HOUSE
 1 CHESHAM STREET
 LONDON, SW 1X 8ND, UNITED KINGDOM

Operator MIDSTREAM LIGHTING LIMITED
 Telephone +44 (0)207 584 8310
 Fax
 e-Mail info@midstreamlighting.com

Only Retrofits ON / Spill Out - House 18 / Table (E, Perpendicular)



Position of surface in external scene:
 Marked point: (41.800 m, -93.315 m,
 1.000 m)



1.000 2.05

0.000 1.70

m 3.500

Attention: The coordinates refer to the image above. Values in Lux.

Grid: 1 x 2 Points

E_{av} [lx]	E_{min} [lx]	E_{max} [lx]	u0	E_{min} / E_{max}
1.88	1.70	2.05	0.91	0.83

MIDSTREAM LIGHTING LIMITED
 WESSEX HOUSE
 1 CHESHAM STREET
 LONDON, SW 1X 8ND, UNITED KINGDOM

Operator MIDSTREAM LIGHTING LIMITED
 Telephone +44 (0)207 584 8310
 Fax
 e-Mail info@midstreamlighting.com

Only Retrofits ON / Spill Out - House 19 / Table (E, Perpendicular)



Position of surface in external scene:
 Marked point: (32.340 m, -91.908 m,
 1.000 m)

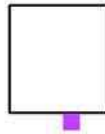

1.000 2.62

0.000 2.17

m 4.000

Attention: The coordinates refer to the image above. Values in Lux.

Grid: 1 x 2 Points

E_{av} [lx]	E_{min} [lx]	E_{max} [lx]	u0	E_{min} / E_{max}
2.40	2.17	2.62	0.91	0.83

MIDSTREAM LIGHTING LIMITED
 WESSEX HOUSE
 1 CHESHAM STREET
 LONDON, SW 1X 8ND, UNITED KINGDOM

Operator MIDSTREAM LIGHTING LIMITED
 Telephone +44 (0)207 584 8310
 Fax
 e-Mail info@midstreamlighting.com

Only Retrofits ON / Spill Out - House 20 / Table (E, Perpendicular)



Position of surface in external scene:
 Marked point: (22.195 m, -90.405 m,
 1.000 m)



1.000 3.28

0.000 2.72

m 4.000

Attention: The coordinates refer to the image above. Values in Lux.

Grid: 1 x 2 Points

E_{av} [lx]
3.00

E_{min} [lx]
2.72

E_{max} [lx]
3.28

u_0
0.91

E_{min} / E_{max}
0.83

MIDSTREAM LIGHTING LIMITED
 WESSEX HOUSE
 1 CHESHAM STREET
 LONDON, SW 1X 8ND, UNITED KINGDOM

Operator MIDSTREAM LIGHTING LIMITED
 Telephone +44 (0)207 584 8310
 Fax
 e-Mail info@midstreamlighting.com

Only Retrofits ON / Spill Out - House 21 / Table (E, Perpendicular)



Position of surface in external scene:
 Marked point: (11.209 m, -88.495 m,
 1.000 m)

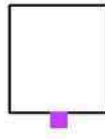

1.000 3.94

0.000 3.24

m **4.000**

Attention: The coordinates refer to the image above. Values in Lux.

Grid: 1 x 2 Points

E_{av} [lx]
3.59

E_{min} [lx]
3.24

E_{max} [lx]
3.94

$u0$
0.90

E_{min} / E_{max}
0.82

MIDSTREAM LIGHTING LIMITED
 WESSEX HOUSE
 1 CHESHAM STREET
 LONDON, SW 1X 8ND, UNITED KINGDOM

Operator MIDSTREAM LIGHTING LIMITED
 Telephone +44 (0)207 584 8310
 Fax
 e-Mail info@midstreamlighting.com

Only Retrofits ON / Spill Out - House 22 / Table (E, Perpendicular)



Position of surface in external scene:
 Marked point: (-1.251 m, -86.736 m,
 1.000 m)

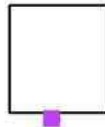

1.000 4.31

0.000 3.58

m **5.000**

Attention: The coordinates refer to the image above. Values in Lux.

Grid: 1 x 2 Points

E_{av} [lx]
3.95

E_{min} [lx]
3.58

E_{max} [lx]
4.31

$u0$
0.91

E_{min} / E_{max}
0.83

MIDSTREAM LIGHTING LIMITED
 WESSEX HOUSE
 1 CHESHAM STREET
 LONDON, SW 1X 8ND, UNITED KINGDOM

Operator MIDSTREAM LIGHTING LIMITED
 Telephone +44 (0)207 584 8310
 Fax
 e-Mail info@midstreamlighting.com

Only Retrofits ON / Spill Out - House 23 / Table (E, Perpendicular)



Position of surface in external scene:
 Marked point: (-11.460 m, -84.956 m,
 1.000 m)



1.000 4.30

0.000 3.60

m **3.500**

Attention: The coordinates refer to the image above. Values in Lux.

Grid: 1 x 2 Points

E_{av} [lx]
3.95

E_{min} [lx]
3.60

E_{max} [lx]
4.30

u_0
0.91

E_{min} / E_{max}
0.84

MIDSTREAM LIGHTING LIMITED
 WESSEX HOUSE
 1 CHESHAM STREET
 LONDON, SW 1X 8ND, UNITED KINGDOM

Operator MIDSTREAM LIGHTING LIMITED
 Telephone +44 (0)207 584 8310
 Fax
 e-Mail info@midstreamlighting.com

Only Retrofits ON / Spill Out - House 24 / Table (E, Perpendicular)



Position of surface in external scene:
 Marked point: (-20.416 m, -83.762 m,
 1.000 m)

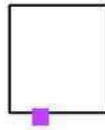

1.000 4.07

0.000 3.41

m **3.500**

Attention: The coordinates refer to the image above. Values in Lux.

Grid: 1 x 2 Points

E_{av} [lx]
3.74

E_{min} [lx]
3.41

E_{max} [lx]
4.07

u0
0.91

E_{min} / E_{max}
0.84

MIDSTREAM LIGHTING LIMITED
 WESSEX HOUSE
 1 CHESHAM STREET
 LONDON, SW 1X 8ND, UNITED KINGDOM

Operator MIDSTREAM LIGHTING LIMITED
 Telephone +44 (0)207 584 8310
 Fax
 e-Mail info@midstreamlighting.com

Only Retrofits ON / Spill Out - House 25 / Table (E, Perpendicular)



Position of surface in external scene:
 Marked point: (-33.732 m, -81.720 m,
 1.000 m)



1.000 3.36

0.000 2.85

m 5.000

Attention: The coordinates refer to the image above. Values in Lux.

Grid: 1 x 2 Points

E_{av} [lx]
3.11

E_{min} [lx]
2.85

E_{max} [lx]
3.36

$u0$
0.92

E_{min} / E_{max}
0.85

MIDSTREAM LIGHTING LIMITED
 WESSEX HOUSE
 1 CHESHAM STREET
 LONDON, SW 1X 8ND, UNITED KINGDOM

Operator MIDSTREAM LIGHTING LIMITED
 Telephone +44 (0)207 584 8310
 Fax
 e-Mail info@midstreamlighting.com

Only Retrofits ON / Spill Out - House 26 / Table (E, Perpendicular)



Position of surface in external scene:
 Marked point: (-46.390 m, -79.929 m,
 1.000 m)

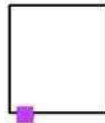

1.000 2.55

0.000 2.21

m 5.000

Attention: The coordinates refer to the image above. Values in Lux.

Grid: 1 x 2 Points

E_{av} [lx]
2.38

E_{min} [lx]
2.21

E_{max} [lx]
2.55

$u0$
0.93

E_{min} / E_{max}
0.87

MIDSTREAM LIGHTING LIMITED
 WESSEX HOUSE
 1 CHESHAM STREET
 LONDON, SW 1X 8ND, UNITED KINGDOM

Operator MIDSTREAM LIGHTING LIMITED
 Telephone +44 (0)207 584 8310
 Fax
 e-Mail info@midstreamlighting.com

Only Retrofits ON / Spill Out - House 27 / Table (E, Perpendicular)



Position of surface in external scene:
 Marked point: (-60.720 m, -78.018 m,
 1.000 m)

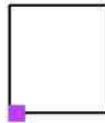

1.000 1.80
0.000 1.63
 m **5.000**

Attention: The coordinates refer to the image above. Values in Lux.

Grid: 1 x 2 Points

E_{av} [lx]	E_{min} [lx]	E_{max} [lx]	$u0$	E_{min} / E_{max}
1.72	1.63	1.80	0.95	0.91

MIDSTREAM LIGHTING LIMITED
 WESSEX HOUSE
 1 CHESHAM STREET
 LONDON, SW 1X 8ND, UNITED KINGDOM

Operator MIDSTREAM LIGHTING LIMITED
 Telephone +44 (0)207 584 8310
 Fax
 e-Mail info@midstreamlighting.com

Only Retrofits ON / Spill Out - House 28 / Table (E, Perpendicular)



Position of surface in external scene:
 Marked point: (-81.388 m, -74.939 m,
 1.000 m)

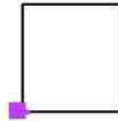

1.000 1.20
0.000 1.13
 m **8.500**

Attention: The coordinates refer to the image above. Values in Lux.

Grid: 1 x 2 Points

E_{av} [lx]	E_{min} [lx]	E_{max} [lx]	$u0$	E_{min} / E_{max}
1.16	1.13	1.20	0.97	0.94

MIDSTREAM LIGHTING LIMITED
 WESSEX HOUSE
 1 CHESHAM STREET
 LONDON, SW 1X 8ND, UNITED KINGDOM

Operator MIDSTREAM LIGHTING LIMITED
 Telephone +44 (0)207 584 8310
 Fax
 e-Mail info@midstreamlighting.com

Only Retrofits ON / Spill Out - House 29 / Table (E, Perpendicular)



Position of surface in external scene:
 Marked point: (-94.733 m, -72.808 m,
 1.000 m)



1.000 0.74

0.000 0.70

m 4.500

Attention: The coordinates refer to the image above. Values in Lux.

Grid: 1 x 2 Points

E_{av} [lx]	E_{min} [lx]	E_{max} [lx]	$u0$	E_{min} / E_{max}
0.72	0.70	0.74	0.97	0.94

MIDSTREAM LIGHTING LIMITED
 WESSEX HOUSE
 1 CHESHAM STREET
 LONDON, SW 1X 8ND, UNITED KINGDOM

Operator MIDSTREAM LIGHTING LIMITED
 Telephone +44 (0)207 584 8310
 Fax
 e-Mail info@midstreamlighting.com

Only Retrofits ON / Spill Out - House 30 / Table (E, Perpendicular)



Position of surface in external scene:
 Marked point: (-103.573 m, -69.333 m,
 1.000 m)



1.000 0.68

0.000 0.64

m 3.500

Attention: The coordinates refer to the image above. Values in Lux.

Grid: 1 x 2 Points

E_{av} [lx]
0.66

E_{min} [lx]
0.64

E_{max} [lx]
0.68

u0
0.97

E_{min} / E_{max}
0.95

MIDSTREAM LIGHTING LIMITED
 WESSEX HOUSE
 1 CHESHAM STREET
 LONDON, SW 1X 8ND, UNITED KINGDOM

Operator MIDSTREAM LIGHTING LIMITED
 Telephone +44 (0)207 584 8310
 Fax
 e-Mail info@midstreamlighting.com

Only Retrofits ON / Spill Out - House 31 / Table (E, Perpendicular)



Position of surface in external scene:
 Marked point: (-110.486 m, -63.666 m,
 1.000 m)

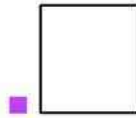

1.000 0.60

0.000 0.57

m 3.500

Attention: The coordinates refer to the image above. Values in Lux.

Grid: 1 x 2 Points

E_{av} [lx]
0.59

E_{min} [lx]
0.57

E_{max} [lx]
0.60

u0
0.98

E_{min} / E_{max}
0.96

MIDSTREAM LIGHTING LIMITED
 WESSEX HOUSE
 1 CHESHAM STREET
 LONDON, SW 1X 8ND, UNITED KINGDOM

Operator MIDSTREAM LIGHTING LIMITED
 Telephone +44 (0)207 584 8310
 Fax
 e-Mail info@midstreamlighting.com

Only Retrofits ON / Spill Out - House 32 / Table (E, Perpendicular)



Position of surface in external scene:
 Marked point: (-116.576 m, -58.292 m,
 1.000 m)



1.000 0.52

0.000 0.50

m 3.500

Attention: The coordinates refer to the image above. Values in Lux.

Grid: 1 x 2 Points

E_{av} [lx]
0.51

E_{min} [lx]
0.50

E_{max} [lx]
0.52

u0
0.98

E_{min} / E_{max}
0.97

MIDSTREAM LIGHTING LIMITED
 WESSEX HOUSE
 1 CHESHAM STREET
 LONDON, SW 1X 8ND, UNITED KINGDOM

Operator MIDSTREAM LIGHTING LIMITED
 Telephone +44 (0)207 584 8310
 Fax
 e-Mail info@midstreamlighting.com

Only Retrofits ON / Spill Out - House 33 / Table (E, Perpendicular)



Position of surface in external scene:
 Marked point: (-118.474 m, -43.022 m,
 1.000 m)

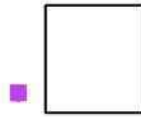

1.000 0.36

0.000 0.36

m 5.000

Attention: The coordinates refer to the image above. Values in Lux.

Grid: 1 x 2 Points

E_{av} [lx]	E_{min} [lx]	E_{max} [lx]	$u0$	E_{min} / E_{max}
0.36	0.36	0.36	0.99	0.99

MIDSTREAM LIGHTING LIMITED
 WESSEX HOUSE
 1 CHESHAM STREET
 LONDON, SW 1X 8ND, UNITED KINGDOM

Operator MIDSTREAM LIGHTING LIMITED
 Telephone +44 (0)207 584 8310
 Fax
 e-Mail info@midstreamlighting.com

Only Retrofits ON / Spill Out - House 34 / Table (E, Perpendicular)



Position of surface in external scene:
 Marked point: (-119.430 m, -23.558 m,
 1.000 m)



1.000 0.41

0.000 0.41

m 5.000

Attention: The coordinates refer to the image above. Values in Lux.

Grid: 1 x 2 Points

E_{av} [lx]
0.41

E_{min} [lx]
0.41

E_{max} [lx]
0.41

$u0$
1.00

E_{min} / E_{max}
0.99

MIDSTREAM LIGHTING LIMITED
 WESSEX HOUSE
 1 CHESHAM STREET
 LONDON, SW 1X 8ND, UNITED KINGDOM

Operator MIDSTREAM LIGHTING LIMITED
 Telephone +44 (0)207 584 8310
 Fax
 e-Mail info@midstreamlighting.com

Only Retrofits ON / Spill Out - House 35 / Table (E, Perpendicular)



Position of surface in external scene:
 Marked point: (-124.229 m, 2.372 m,
 1.000 m)

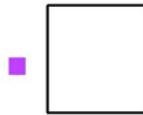

1.000 0.40

0.000 0.41

m 5.000

Attention: The coordinates refer to the image above. Values in Lux.

Grid: 1 x 2 Points

E_{av} [lx]	E_{min} [lx]	E_{max} [lx]	$u0$	E_{min} / E_{max}
0.40	0.40	0.41	0.99	0.98

MIDSTREAM LIGHTING LIMITED
 WESSEX HOUSE
 1 CHESHAM STREET
 LONDON, SW 1X 8ND, UNITED KINGDOM

Operator MIDSTREAM LIGHTING LIMITED
 Telephone +44 (0)207 584 8310
 Fax
 e-Mail info@midstreamlighting.com

Only Retrofits ON / Spill Out - House 36 / Table (E, Perpendicular)



Position of surface in external scene:
 Marked point: (-130.952 m, 24.058 m,
 1.000 m)

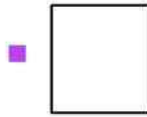

1.000 0.32

0.000 0.34

m 5.000

Attention: The coordinates refer to the image above. Values in Lux.

Grid: 1 x 2 Points

E_{av} [lx]
0.33

E_{min} [lx]
0.32

E_{max} [lx]
0.34

$u0$
0.98

E_{min} / E_{max}
0.96

MIDSTREAM LIGHTING LIMITED
 WESSEX HOUSE
 1 CHESHAM STREET
 LONDON, SW 1X 8ND, UNITED KINGDOM

Operator MIDSTREAM LIGHTING LIMITED
 Telephone +44 (0)207 584 8310
 Fax
 e-Mail info@midstreamlighting.com

Only Retrofits ON / Spill Out - House 37 / Table (E, Perpendicular)



Position of surface in external scene:
 Marked point: (-138.256 m, 47.354 m,
 1.000 m)

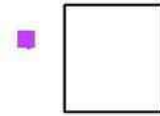

1.000 0.24

0.000 0.25

m **6.000**

Attention: The coordinates refer to the image above. Values in Lux.

Grid: 1 x 2 Points

E_{av} [lx]
0.25

E_{min} [lx]
0.24

E_{max} [lx]
0.25

u0
0.97

E_{min} / E_{max}
0.94

MIDSTREAM LIGHTING LIMITED
 WESSEX HOUSE
 1 CHESHAM STREET
 LONDON, SW 1X 8ND, UNITED KINGDOM

Operator MIDSTREAM LIGHTING LIMITED
 Telephone +44 (0)207 584 8310
 Fax
 e-Mail info@midstreamlighting.com

Only Retrofits ON / Spill Out - House 38 / Table (E, Perpendicular)



Position of surface in external scene:
 Marked point: (-146.347 m, 67.639 m,
 1.000 m)



1.000 0.17

0.000 0.19

m 4.500

Attention: The coordinates refer to the image above. Values in Lux.

Grid: 1 x 2 Points

E_{av} [lx]	E_{min} [lx]	E_{max} [lx]	u0	E_{min} / E_{max}
0.18	0.17	0.19	0.96	0.92

MIDSTREAM LIGHTING LIMITED
 WESSEX HOUSE
 1 CHESHAM STREET
 LONDON, SW 1X 8ND, UNITED KINGDOM

Operator MIDSTREAM LIGHTING LIMITED
 Telephone +44 (0)207 584 8310
 Fax
 e-Mail info@midstreamlighting.com

Only Retrofits ON / Spill Out - House 39 / Table (E, Perpendicular)



Position of surface in external scene:
 Marked point: (-153.651 m, 80.547 m,
 1.000 m)

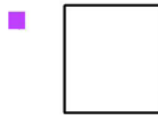

1.000 0.14
0.000 0.15
m 5.500

Attention: The coordinates refer to the image above. Values in Lux.

Grid: 1 x 2 Points

E_{av} [lx]	E_{min} [lx]	E_{max} [lx]	$u0$	E_{min} / E_{max}
0.14	0.14	0.15	0.96	0.92

MIDSTREAM LIGHTING LIMITED
 WESSEX HOUSE
 1 CHESHAM STREET
 LONDON, SW 1X 8ND, UNITED KINGDOM

Operator MIDSTREAM LIGHTING LIMITED
 Telephone +44 (0)207 584 8310
 Fax
 e-Mail info@midstreamlighting.com

Only Retrofits ON / Spill Out - House 40 / Table (E, Perpendicular)



Position of surface in external scene:
 Marked point: (-161.880 m, 95.588 m,
 1.000 m)

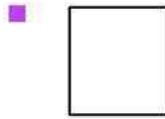

1.000 0.10

0.000 0.11

m 5.000

Attention: The coordinates refer to the image above. Values in Lux.

Grid: 1 x 2 Points

E_{av} [lx]	E_{min} [lx]	E_{max} [lx]	$u0$	E_{min} / E_{max}
0.11	0.10	0.11	0.96	0.93

MIDSTREAM LIGHTING LIMITED
 WESSEX HOUSE
 1 CHESHAM STREET
 LONDON, SW 1X 8ND, UNITED KINGDOM

Operator MIDSTREAM LIGHTING LIMITED
 Telephone +44 (0)207 584 8310
 Fax
 e-Mail info@midstreamlighting.com

Only Retrofits ON / Spill Out - House 41 / Table (E, Perpendicular)



Position of surface in external scene:
 Marked point: (-166.409 m,
 109.315 m, 1.000 m)



1.000 0.08

0.000 0.09

m 4.500

Attention: The coordinates refer to the image above. Values in Lux.

Grid: 1 x 2 Points

E_{av} [lx]	E_{min} [lx]	E_{max} [lx]	$u0$	E_{min} / E_{max}
0.09	0.08	0.09	0.95	0.91

MIDSTREAM LIGHTING LIMITED
 WESSEX HOUSE
 1 CHESHAM STREET
 LONDON, SW 1X 8ND, UNITED KINGDOM

Operator MIDSTREAM LIGHTING LIMITED
 Telephone +44 (0)207 584 8310
 Fax
 e-Mail info@midstreamlighting.com

Only Retrofits ON / Spill Out - House 42 / Table (E, Perpendicular)



Position of surface in external scene:
 Marked point: (-170.956 m,
 121.501 m, 1.000 m)



1.000 0.07
0.000 0.08
m **5.000**

Attention: The coordinates refer to the image above. Values in Lux.

Grid: 1 x 2 Points

E_{av} [lx]	E_{min} [lx]	E_{max} [lx]	$u0$	E_{min} / E_{max}
0.07	0.07	0.08	0.95	0.91

MIDSTREAM LIGHTING LIMITED
 WESSEX HOUSE
 1 CHESHAM STREET
 LONDON, SW 1X 8ND, UNITED KINGDOM

Operator MIDSTREAM LIGHTING LIMITED
 Telephone +44 (0)207 584 8310
 Fax
 e-Mail info@midstreamlighting.com

Only Retrofits ON / Spill Out - House 43 / Table (E, Perpendicular)



Position of surface in external scene:
 Marked point: (-172.747 m,
 133.801 m, 1.000 m)



1.000 0.06
0.000 0.07
 m **5.000**

Attention: The coordinates refer to the image above. Values in Lux.

Grid: 1 x 2 Points

E_{av} [lx]	E_{min} [lx]	E_{max} [lx]	$u0$	E_{min} / E_{max}
0.07	0.06	0.07	0.96	0.92

MIDSTREAM LIGHTING LIMITED
 WESSEX HOUSE
 1 CHESHAM STREET
 LONDON, SW 1X 8ND, UNITED KINGDOM

Operator MIDSTREAM LIGHTING LIMITED
 Telephone +44 (0)207 584 8310
 Fax
 e-Mail info@midstreamlighting.com

ALL ON / Planning data

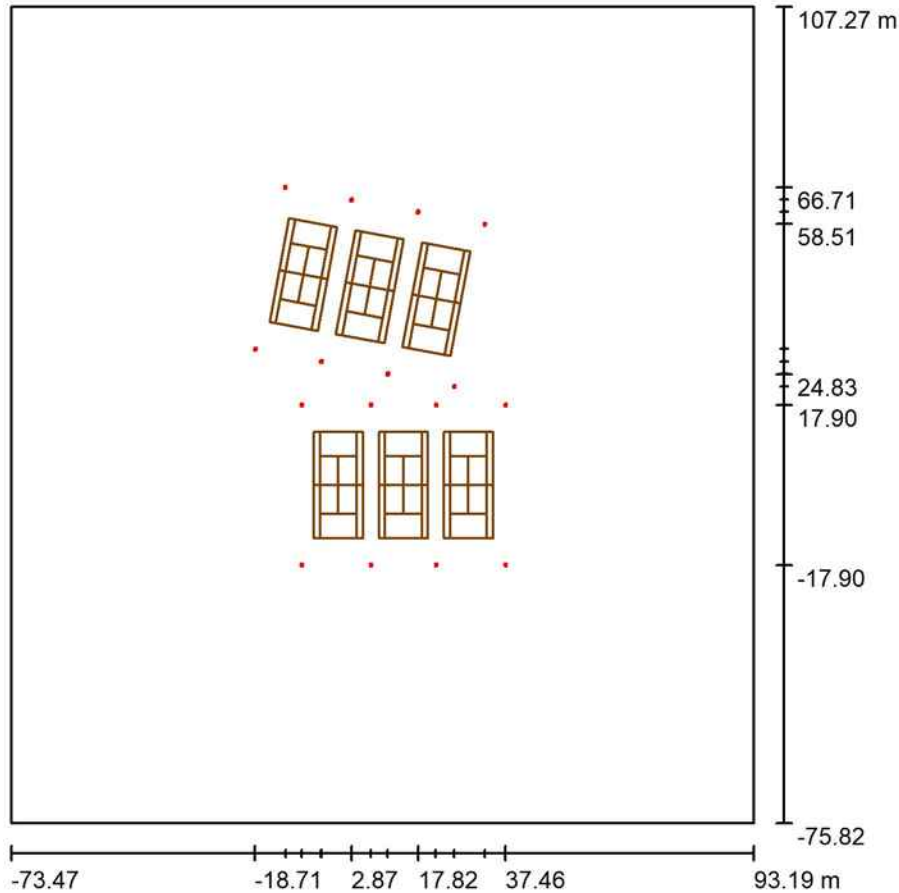

Maintenance factor: 0.90, ULR (Upward Light Ratio): 0.5%

Scale 1:1697

Luminaire Parts List

No.	Pieces	Designation (Correction Factor)	Φ (Luminaire) [lm]	Φ (Lamps) [lm]	P [W]
1	24	MIDSTREAM - Modus S1100 WS (5000K) (1.000)	135501	135500	1180.0
Total:			3252021	3252000	28320.0

MIDSTREAM LIGHTING LIMITED
WESSEX HOUSE
1 CHESHAM STREET
LONDON, SW 1X 8ND, UNITED KINGDOM

Operator MIDSTREAM LIGHTING LIMITED
Telephone +44 (0)207 584 8310
Fax
e-Mail info@midstreamlighting.com

ALL ON / Luminaire parts list

24 Pieces MIDSTREAM - Modus S1100 WS (5000K)
Article No.:
Luminous flux (Luminaire): 135501 lm
Luminous flux (Lamps): 135500 lm
Luminaire Wattage: 1180.0 W
Luminaire classification according to CIE: 100
CIE flux code: 31 67 95 100 100
Fitting: 1 x LED (Correction Factor 1.000).

See our luminaire catalog
for an image of the
luminaire.

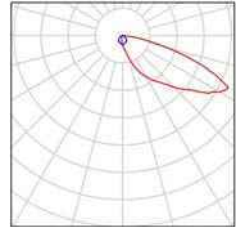

MIDSTREAM LIGHTING LIMITED
 WESSEX HOUSE
 1 CHESHAM STREET
 LONDON, SW 1X 8ND, UNITED KINGDOM

Operator MIDSTREAM LIGHTING LIMITED
 Telephone +44 (0)207 584 8310
 Fax
 e-Mail info@midstreamlighting.com

ALL ON / Luminaires (layout plan)

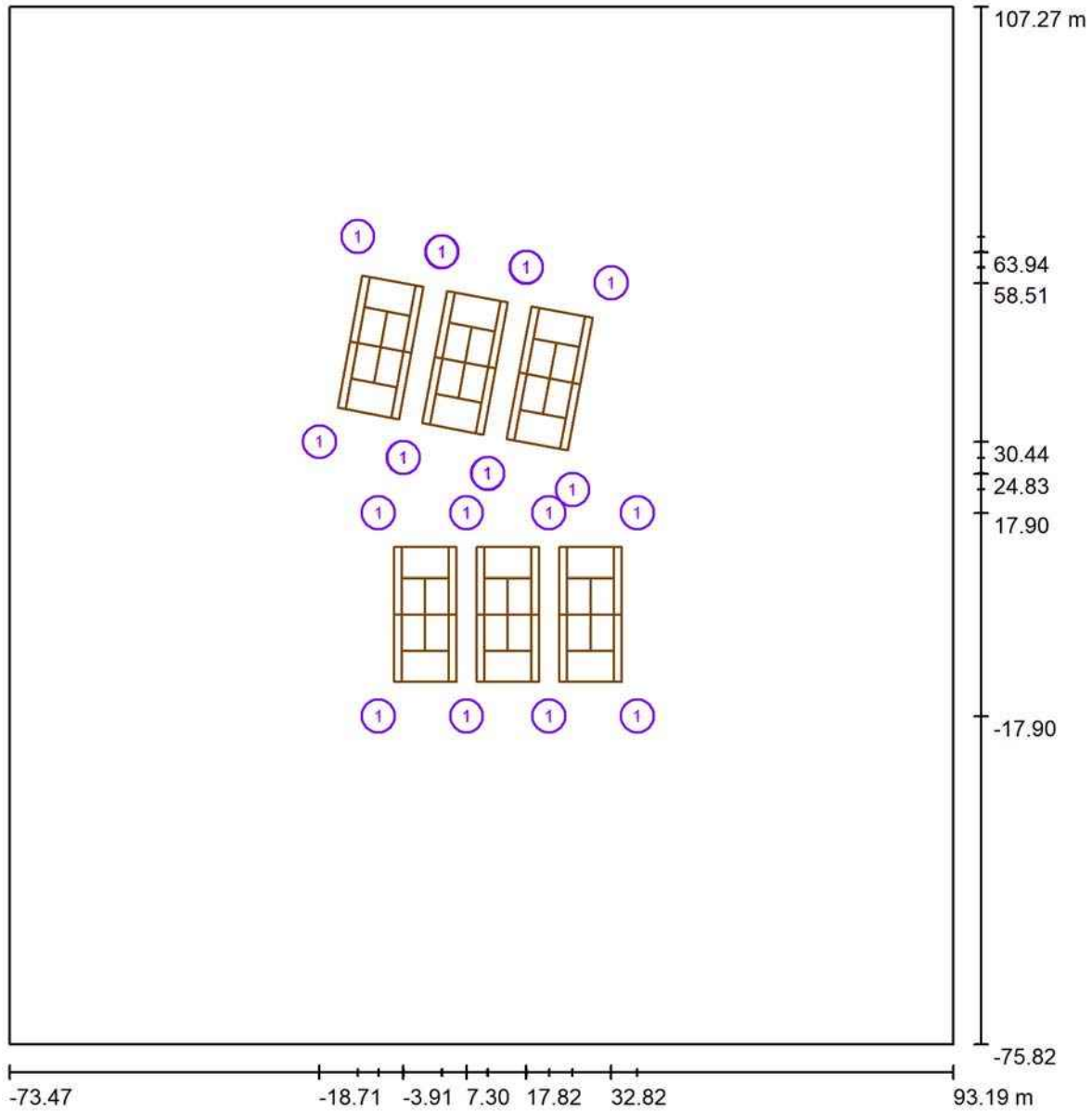

Scale 1 : 1239

Luminaire Parts List

No.	Pieces	Designation
1	24	MIDSTREAM - Modus S1100 WS (5000K)

MIDSTREAM LIGHTING LIMITED
 WESSEX HOUSE
 1 CHESHAM STREET
 LONDON, SW 1X 8ND, UNITED KINGDOM

Operator MIDSTREAM LIGHTING LIMITED
 Telephone +44 (0)207 584 8310
 Fax
 e-Mail info@midstreamlighting.com

ALL ON / Luminaires (coordinates list)

MIDSTREAM - Modus S1100 WS (5000K)

135501 lm, 1180.0 W, 1 x 1 x LED (Correction Factor 1.000).

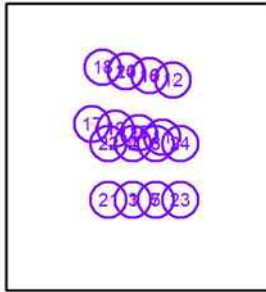

No.	Position [m]			Rotation [°]		
	X	Y	Z	X	Y	Z
1	7.300	-17.900	8.500	0.0	-1.5	106.8
2	7.300	17.901	8.500	0.0	-1.5	-106.8
3	7.300	-17.900	8.500	0.0	-1.4	74.5
4	7.300	17.901	8.500	0.0	-1.4	-74.5
5	21.840	-17.900	8.500	0.0	-1.4	105.5
6	21.840	17.901	8.500	0.0	-1.4	-105.5
7	21.840	-17.900	8.500	0.0	-1.5	73.1
8	21.840	17.901	8.500	0.0	-1.5	-73.1
9	11.047	24.827	8.500	0.0	-2.2	64.6
10	17.874	61.304	8.500	0.0	-2.2	-85.8
11	25.994	22.030	8.500	0.0	-2.2	94.2
12	32.821	58.507	8.500	0.0	-2.2	-115.4
13	-3.823	27.645	8.500	0.0	-2.1	64.7
14	2.981	64.004	8.500	0.0	-2.1	-85.9
15	11.015	24.868	8.500	0.0	-2.1	94.1
16	17.819	61.227	8.500	0.0	-2.1	-115.3
17	-18.712	30.439	8.500	0.0	-1.9	64.8
18	-11.924	66.708	8.500	0.0	-1.9	-86.0
19	-3.914	27.670	8.500	0.0	-1.9	94.0
20	2.874	63.939	8.500	0.0	-1.9	-115.2
21	-8.300	-17.900	8.500	0.0	-1.7	71.4
22	-8.300	17.901	8.500	0.0	-1.7	-71.4
23	37.460	-17.900	8.500	0.0	-1.9	109.1
24	37.460	17.901	8.500	0.0	-1.9	-109.1

MIDSTREAM LIGHTING LIMITED
 WESSEX HOUSE
 1 CHESHAM STREET
 LONDON, SW 1X 8ND, UNITED KINGDOM

Operator MIDSTREAM LIGHTING LIMITED
 Telephone +44 (0)207 584 8310
 Fax
 e-Mail info@midstreamlighting.com

ALL ON / Sport Luminaires (Coordinates List)

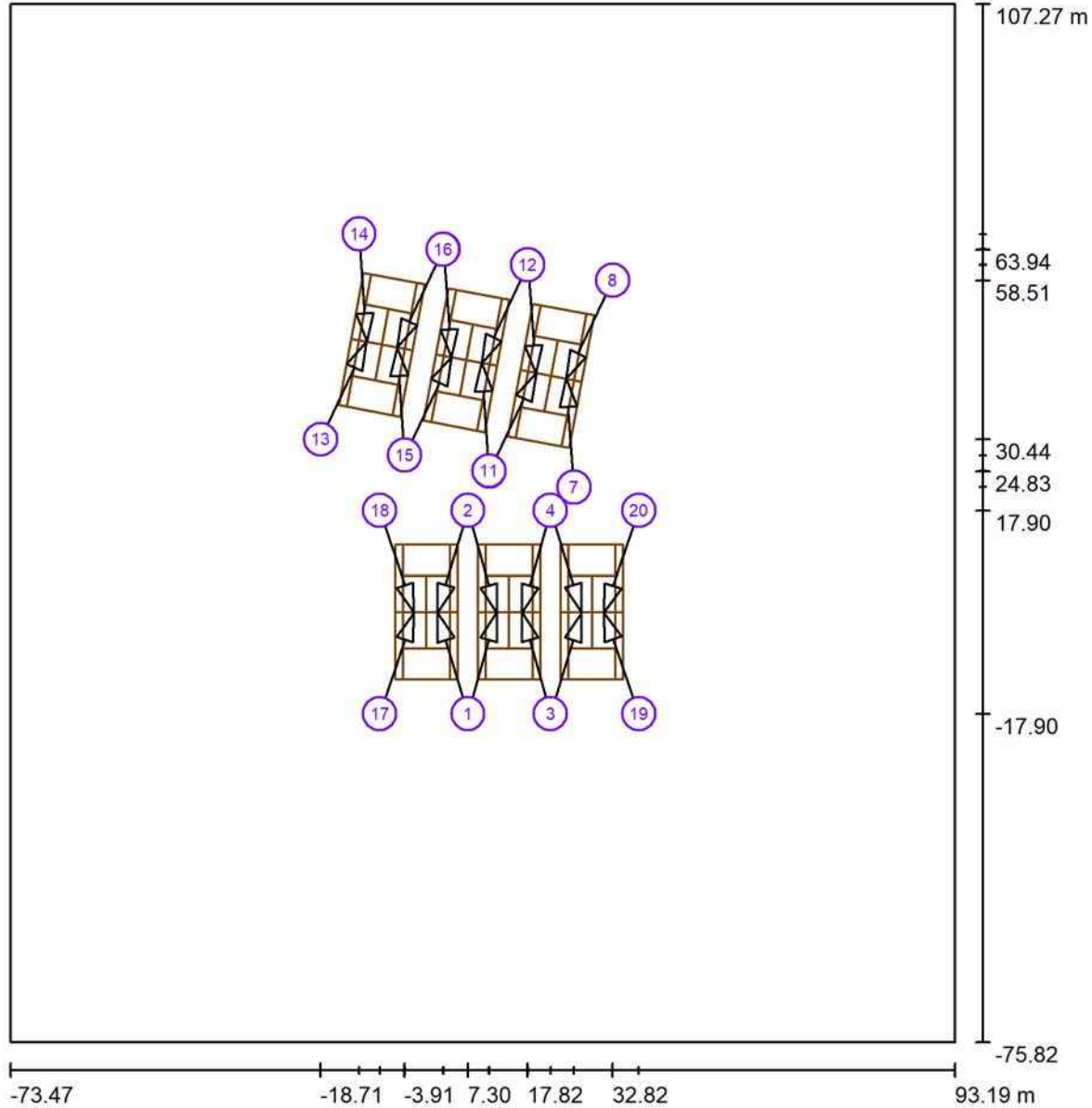

Scale 1 : 1239

List of the Sport Luminaires

Luminaire	Index	Position [m]			Aiming Point [m]			Angle [°]	Alignment	Pole
		X	Y	Z	X	Y	Z			
MIDSTREAM - Modus S1100 WS (5000K)	1	7.300	-17.900	8.500	1.898	-0.047	0.000	24.5	(C IMax, G IMax)	Pole Position 1
MIDSTREAM - Modus S1100 WS (5000K)	2	7.300	17.901	8.500	1.898	0.048	0.000	24.5	(C IMax, G IMax)	Pole Position 2
MIDSTREAM - Modus S1100 WS (5000K)	1	7.300	-17.900	8.500	12.271	0.022	0.000	24.6	(C IMax, G IMax)	Pole Position 1
MIDSTREAM - Modus S1100 WS (5000K)	2	7.300	17.901	8.500	12.271	-0.021	0.000	24.6	(C IMax, G IMax)	Pole Position 2

MIDSTREAM LIGHTING LIMITED
 WESSEX HOUSE
 1 CHESHAM STREET
 LONDON, SW 1X 8ND, UNITED KINGDOM

Operator MIDSTREAM LIGHTING LIMITED
 Telephone +44 (0)207 584 8310
 Fax
 e-Mail info@midstreamlighting.com

ALL ON / Sport Luminaires (Coordinates List)

List of the Sport Luminaires

Luminaire	Index	Position [m]			Aiming Point [m]			Angle [°]	Alignment	Pole
		X	Y	Z	X	Y	Z			
MIDSTREAM - Modus S1100 WS (5000K)	3	21.840	-17.900	8.500	16.869	0.022	0.000	24.6	(C IMax, G IMax)	Pole Position 3
MIDSTREAM - Modus S1100 WS (5000K)	4	21.840	17.901	8.500	16.869	-0.021	0.000	24.6	(C IMax, G IMax)	Pole Position 4
MIDSTREAM - Modus S1100 WS (5000K)	3	21.840	-17.900	8.500	27.278	-0.053	0.000	24.5	(C IMax, G IMax)	Pole Position 3
MIDSTREAM - Modus S1100 WS (5000K)	4	21.840	17.901	8.500	27.278	0.054	0.000	24.5	(C IMax, G IMax)	Pole Position 4
MIDSTREAM - Modus S1100 WS (5000K)	5	11.047	24.827	8.500	19.305	42.224	0.000	23.8	(C IMax, G IMax)	Pole Position 5
MIDSTREAM - Modus S1100 WS (5000K)	6	17.874	61.304	8.500	19.281	42.098	0.000	23.8	(C IMax, G IMax)	Pole Position 6
MIDSTREAM - Modus S1100 WS (5000K)	7	25.994	22.030	8.500	24.587	41.236	0.000	23.8	(C IMax, G IMax)	Pole Position 7
MIDSTREAM - Modus S1100 WS (5000K)	8	32.821	58.507	8.500	24.563	41.110	0.000	23.8	(C IMax, G IMax)	Pole Position 8
MIDSTREAM - Modus S1100 WS (5000K)	9	-3.823	27.645	8.500	4.353	44.968	0.000	23.9	(C IMax, G IMax)	Pole Position 9
MIDSTREAM - Modus S1100 WS (5000K)	10	2.981	64.004	8.500	4.340	44.897	0.000	23.9	(C IMax, G IMax)	Pole Position 10
MIDSTREAM - Modus S1100 WS (5000K)	11	11.015	24.868	8.500	9.656	43.975	0.000	23.9	(C IMax, G IMax)	Pole Position 5
MIDSTREAM - Modus S1100 WS (5000K)	12	17.819	61.227	8.500	9.643	43.904	0.000	23.9	(C IMax, G IMax)	Pole Position 6
MIDSTREAM - Modus S1100 WS (5000K)	13	-18.712	30.439	8.500	-10.609	47.657	0.000	24.1	(C IMax, G IMax)	Pole Position 11
MIDSTREAM - Modus S1100 WS (5000K)	14	-11.924	66.708	8.500	-10.596	47.725	0.000	24.1	(C IMax, G IMax)	Pole Position 12
MIDSTREAM - Modus S1100 WS (5000K)	15	-3.914	27.670	8.500	-5.242	46.653	0.000	24.1	(C IMax, G IMax)	Pole Position 9
MIDSTREAM - Modus S1100 WS (5000K)	16	2.874	63.939	8.500	-5.229	46.721	0.000	24.1	(C IMax, G IMax)	Pole Position 10
MIDSTREAM - Modus S1100 WS (5000K)	17	-8.300	-17.900	8.500	-2.292	-0.044	0.000	24.3	(C IMax, G IMax)	Pole Position 13
MIDSTREAM - Modus S1100 WS (5000K)	18	-8.300	17.901	8.500	-2.292	0.045	0.000	24.3	(C IMax, G IMax)	Pole Position 14
MIDSTREAM - Modus S1100 WS (5000K)	19	37.460	-17.900	8.500	31.249	0.031	0.000	24.1	(C IMax, G IMax)	Pole Position 15
MIDSTREAM - Modus S1100 WS (5000K)	20	37.460	17.901	8.500	31.249	-0.030	0.000	24.1	(C IMax, G IMax)	Pole Position 16

MIDSTREAM LIGHTING LIMITED
WESSEX HOUSE
1 CHESHAM STREET
LONDON, SW 1X 8ND, UNITED KINGDOM

Operator MIDSTREAM LIGHTING LIMITED
Telephone +44 (0)207 584 8310
Fax
e-Mail info@midstreamlighting.com

ALL ON / 3D Rendering

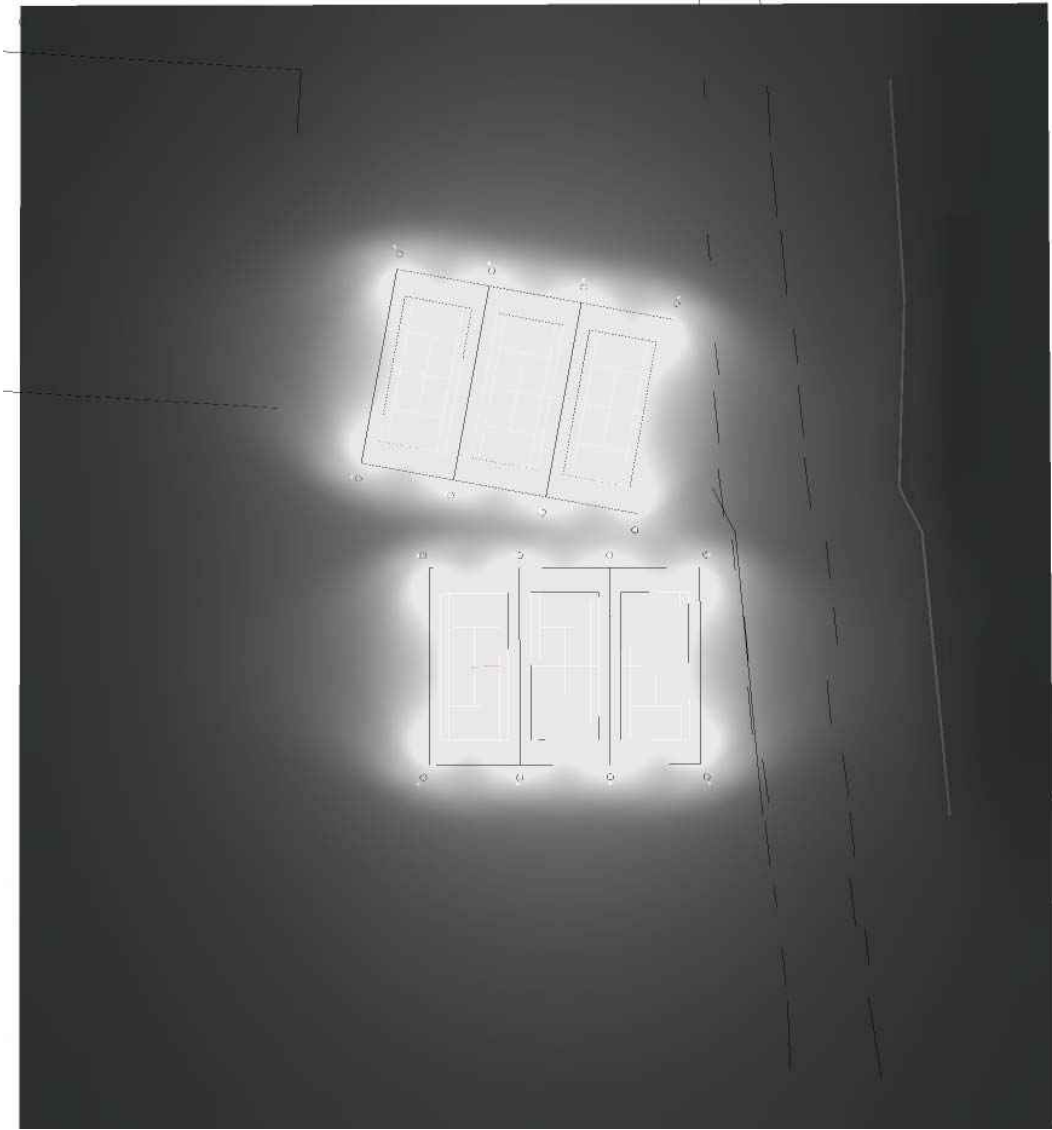

MIDSTREAM LIGHTING LIMITED
WESSEX HOUSE
1 CHESHAM STREET
LONDON, SW 1X 8ND, UNITED KINGDOM

Operator MIDSTREAM LIGHTING LIMITED
Telephone +44 (0)207 584 8310
Fax
e-Mail info@midstreamlighting.com

ALL ON / False Colour Rendering

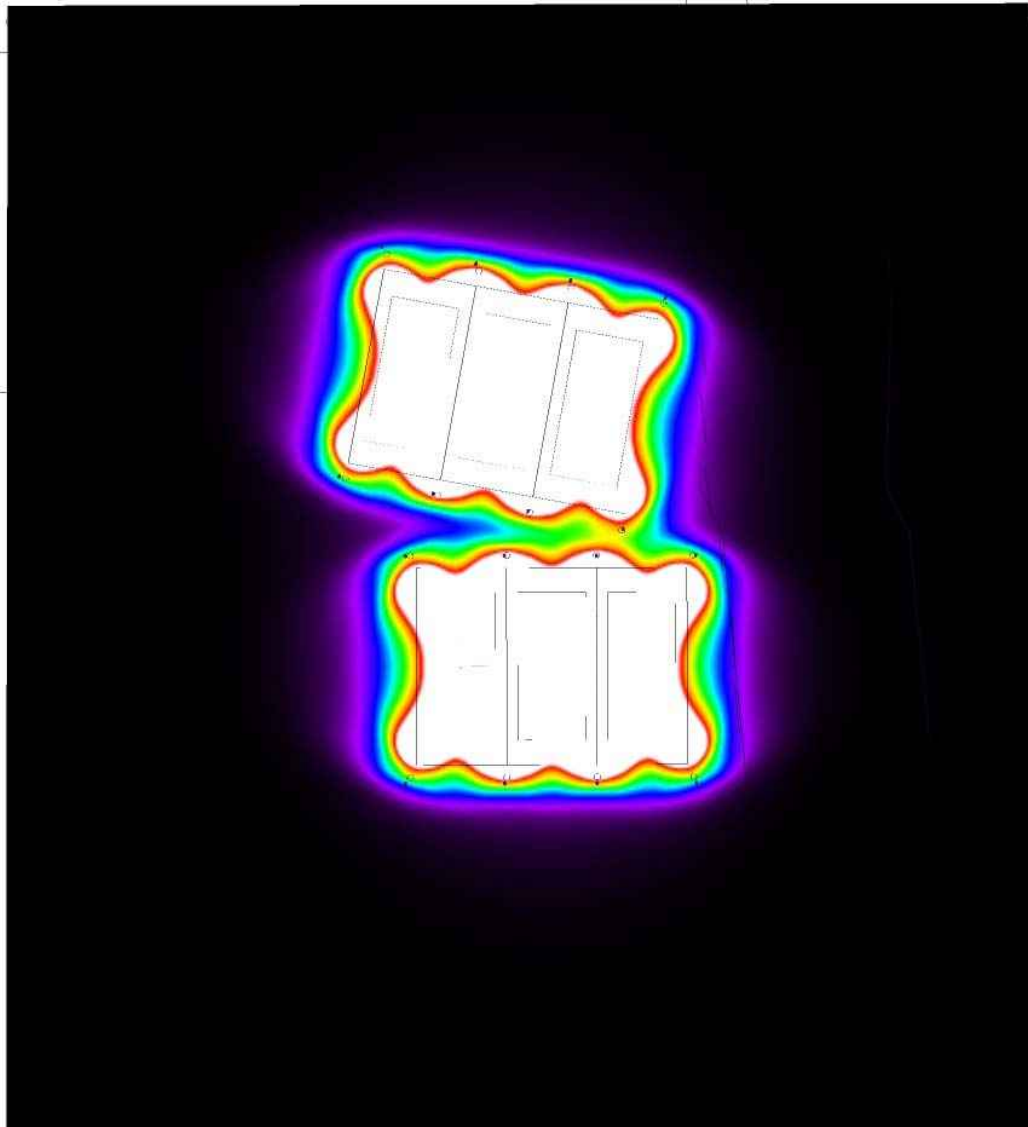

3.01 58.88 114.76 170.63 226.50 282.38 338.25 394.13 450

lx



MIDSTREAM LIGHTING LIMITED
 WESSEX HOUSE
 1 CHESHAM STREET
 LONDON, SW 1X 8ND, UNITED KINGDOM

Operator MIDSTREAM LIGHTING LIMITED
 Telephone +44 (0)207 584 8310
 Fax
 e-Mail info@midstreamlighting.com

ALL ON / Tennis 1 Calculation Grid (TPA) / Summary

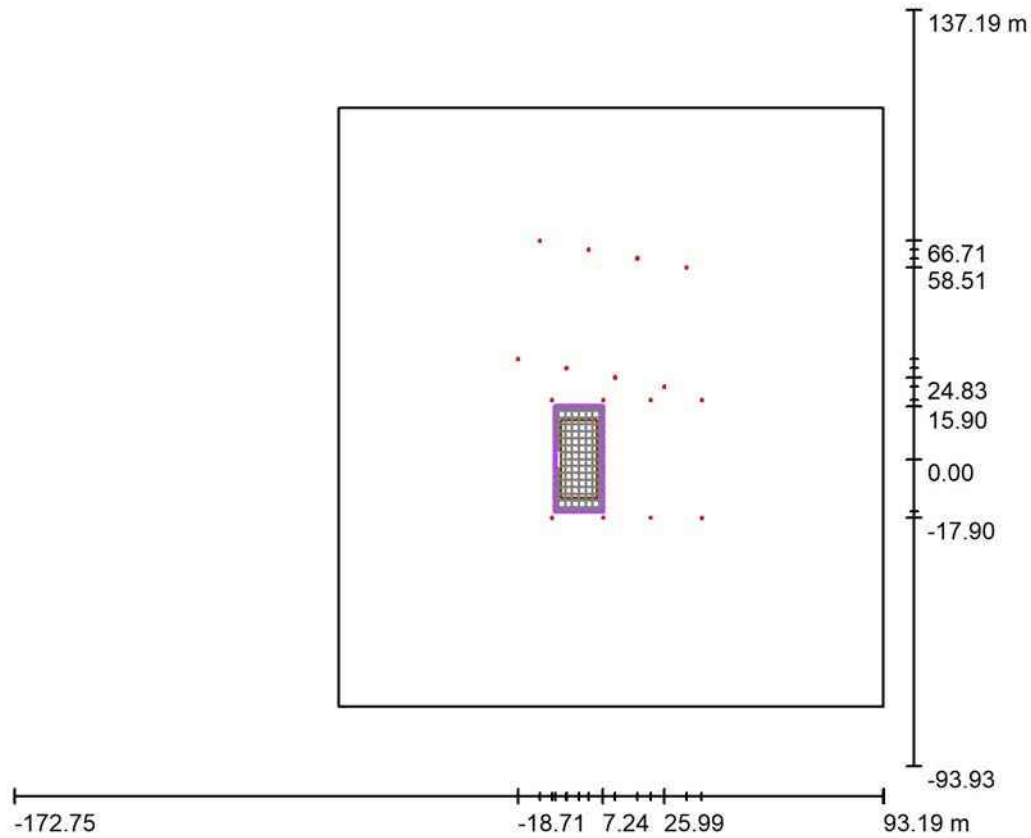

Scale 1 : 2314

Position: (-0.010 m, 0.000 m, 0.000 m)
 Size: (31.800 m, 14.500 m)
 Rotation: (0.0°, 0.0°, 90.0°)
 Type: User defined, Quantity Points: 102
 Belongs to the following sport arena: Tennis 1

Results overview

No.	Type	E_{av} [lx]	E_{min} [lx]	E_{max} [lx]	u0	E_{min} / E_{max}	$E_{h\ m} / E_m$	H [m]	Camera
1	horizontal	747	448	1498	0.60	0.30	/	0.000	/

$E_{h\ m} / E_m$ = Relationship between middle horizontal and vertical illuminance, H = Measuring Height

MIDSTREAM LIGHTING LIMITED
 WESSEX HOUSE
 1 CHESHAM STREET
 LONDON, SW 1X 8ND, UNITED KINGDOM

Operator MIDSTREAM LIGHTING LIMITED
 Telephone +44 (0)207 584 8310
 Fax
 e-Mail info@midstreamlighting.com

ALL ON / Tennis 1 Calculation Grid (TPA) / Value Chart (E, Horizontal)

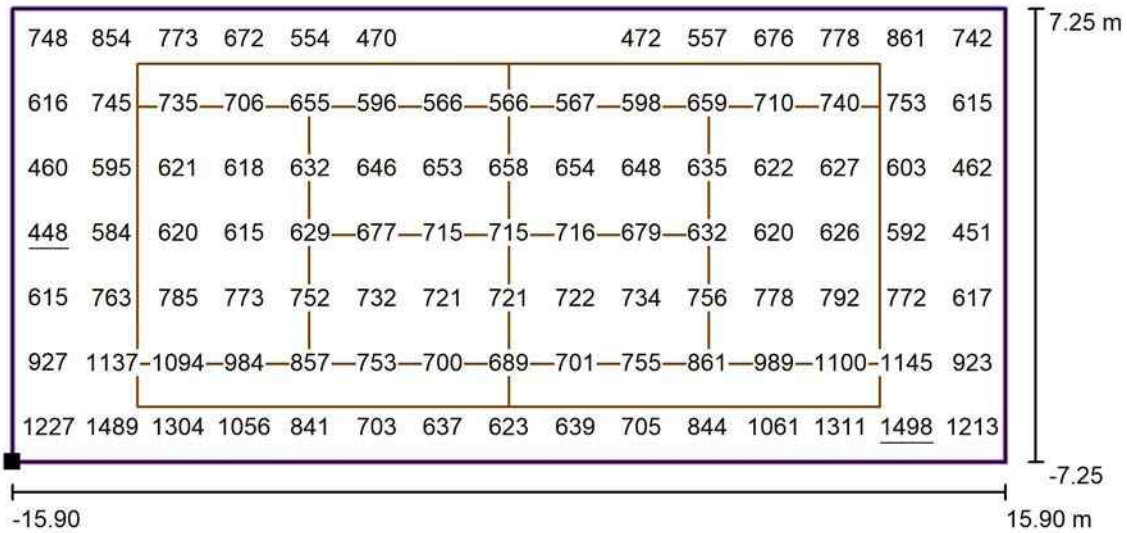

Values in Lux, Scale 1 : 242

Position of surface in external scene:
 Marked point: (7.240 m, -15.900 m,
 0.000 m)

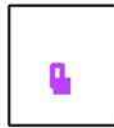

Grid: 102 Points

E_{av} [lx]
747

E_{min} [lx]
448

E_{max} [lx]
1498

u_0
0.60

E_{min} / E_{max}
0.30

MIDSTREAM LIGHTING LIMITED
 WESSEX HOUSE
 1 CHESHAM STREET
 LONDON, SW 1X 8ND, UNITED KINGDOM

Operator MIDSTREAM LIGHTING LIMITED
 Telephone +44 (0)207 584 8310
 Fax
 e-Mail info@midstreamlighting.com

ALL ON / Tennis 1 Calculation Grid (PPA) / Summary

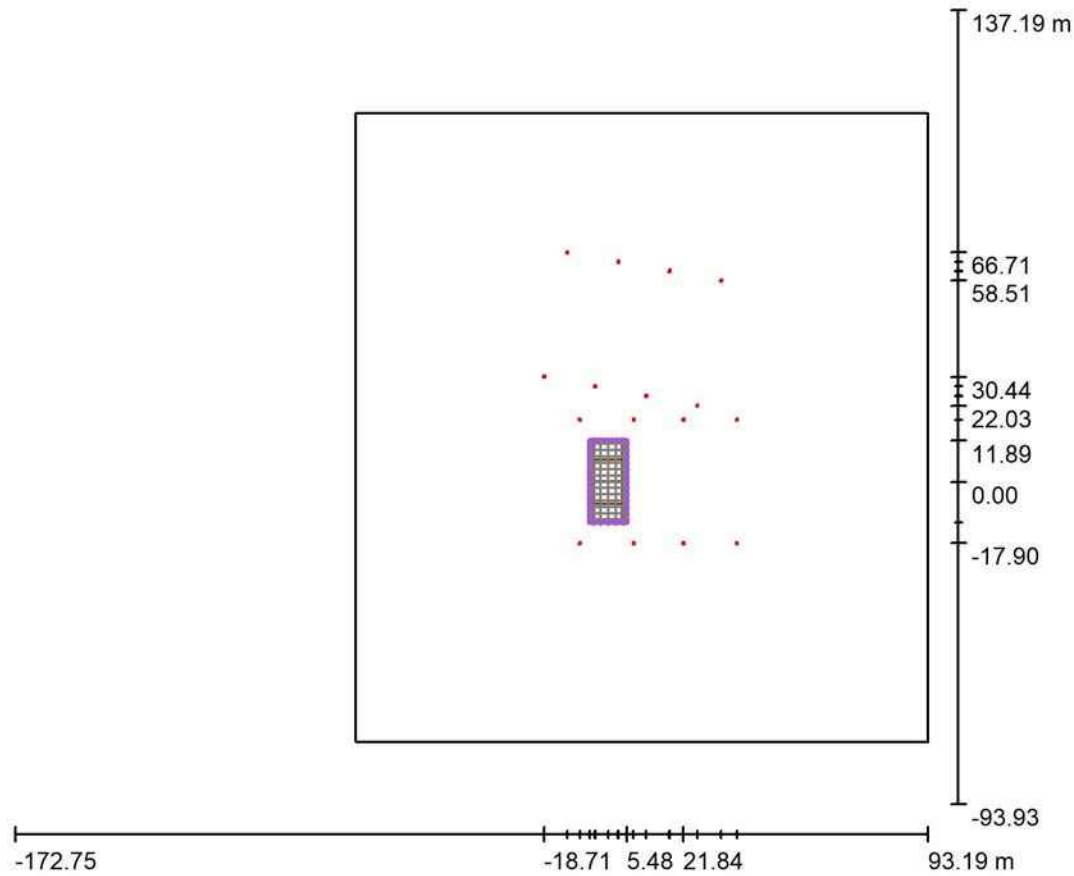

Scale 1 : 2204

Position: (0.000 m, 0.000 m, 0.000 m)
 Size: (23.780 m, 10.970 m)
 Rotation: (0.0°, 0.0°, 90.0°)
 Type: Normal, Grid: 13 x 5 Points
 Belongs to the following sport arena: Tennis 1

Results overview

No.	Type	E_{av} [lx]	E_{min} [lx]	E_{max} [lx]	u0	E_{min} / E_{max}	$E_{h\ m} / E_m$	H [m]	Camera
1	horizontal	716	551	1156	0.77	0.48	/	0.000	/

$E_{h\ m} / E_m$ = Relationship between middle horizontal and vertical illuminance, H = Measuring Height

MIDSTREAM LIGHTING LIMITED
 WESSEX HOUSE
 1 CHESHAM STREET
 LONDON, SW 1X 8ND, UNITED KINGDOM

Operator MIDSTREAM LIGHTING LIMITED
 Telephone +44 (0)207 584 8310
 Fax
 e-Mail info@midstreamlighting.com

ALL ON / Tennis 1 Calculation Grid (PPA) / Value Chart (E, Horizontal)

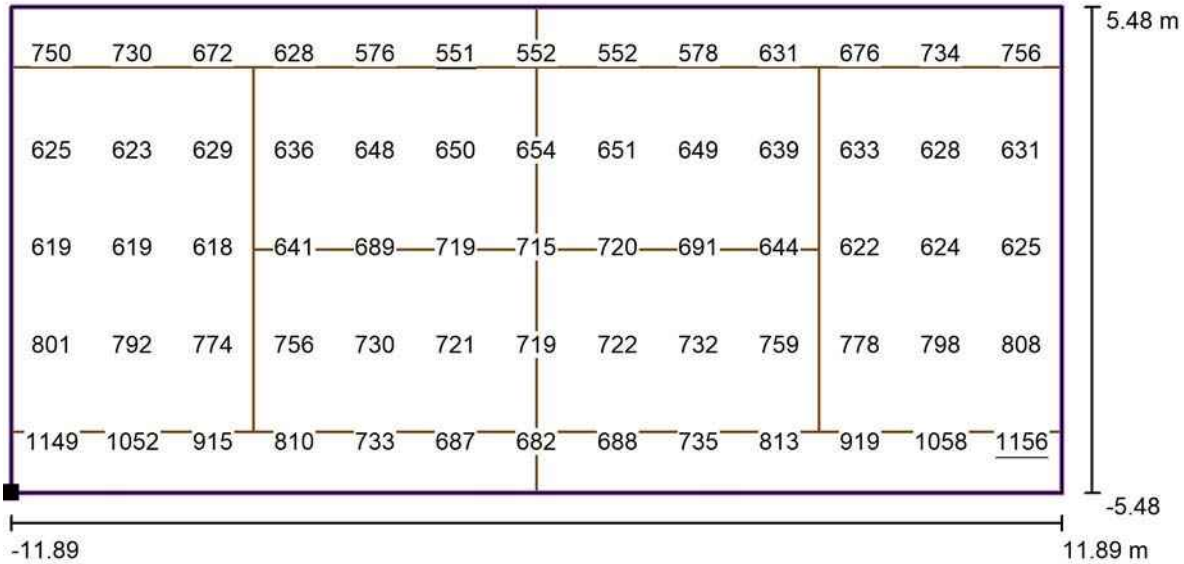

Values in Lux, Scale 1 : 171

Position of surface in external scene:
 Marked point: (5.485 m, -11.890 m,
 0.000 m)



Grid: 13 x 5 Points

E_{av} [lx]
716

E_{min} [lx]
551

E_{max} [lx]
1156

u_0
0.77

E_{min} / E_{max}
0.48

MIDSTREAM LIGHTING LIMITED
 WESSEX HOUSE
 1 CHESHAM STREET
 LONDON, SW 1X 8ND, UNITED KINGDOM

Operator MIDSTREAM LIGHTING LIMITED
 Telephone +44 (0)207 584 8310
 Fax
 e-Mail info@midstreamlighting.com

ALL ON / Tennis 2 Calculation Grid (TPA) / Summary

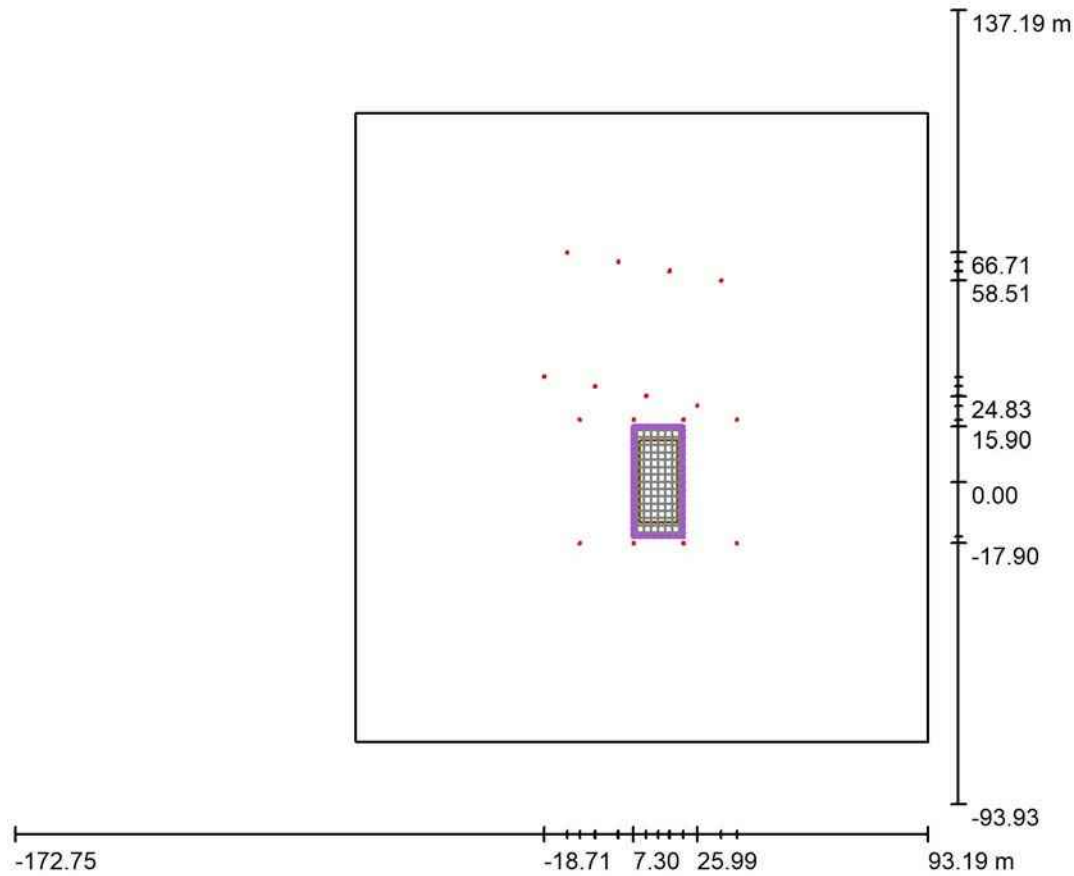

Scale 1 : 2204

Position: (14.570 m, 0.000 m, 0.000 m)
 Size: (31.800 m, 14.500 m)
 Rotation: (0.0°, 0.0°, 90.0°)
 Type: Normal, Grid: 15 x 7 Points
 Belongs to the following sport arena: Tennis 2

Results overview

No.	Type	E_{av} [lx]	E_{min} [lx]	E_{max} [lx]	u0	E_{min} / E_{max}	$E_{h\ m} / E_m$	H [m]	Camera
1	horizontal	878	537	1497	0.61	0.36	/	0.000	/

$E_{h\ m} / E_m$ = Relationship between middle horizontal and vertical illuminance, H = Measuring Height

MIDSTREAM LIGHTING LIMITED
 WESSEX HOUSE
 1 CHESHAM STREET
 LONDON, SW 1X 8ND, UNITED KINGDOM

Operator MIDSTREAM LIGHTING LIMITED
 Telephone +44 (0)207 584 8310
 Fax
 e-Mail info@midstreamlighting.com

ALL ON / Tennis 2 Calculation Grid (TPA) / Value Chart (E, Horizontal)

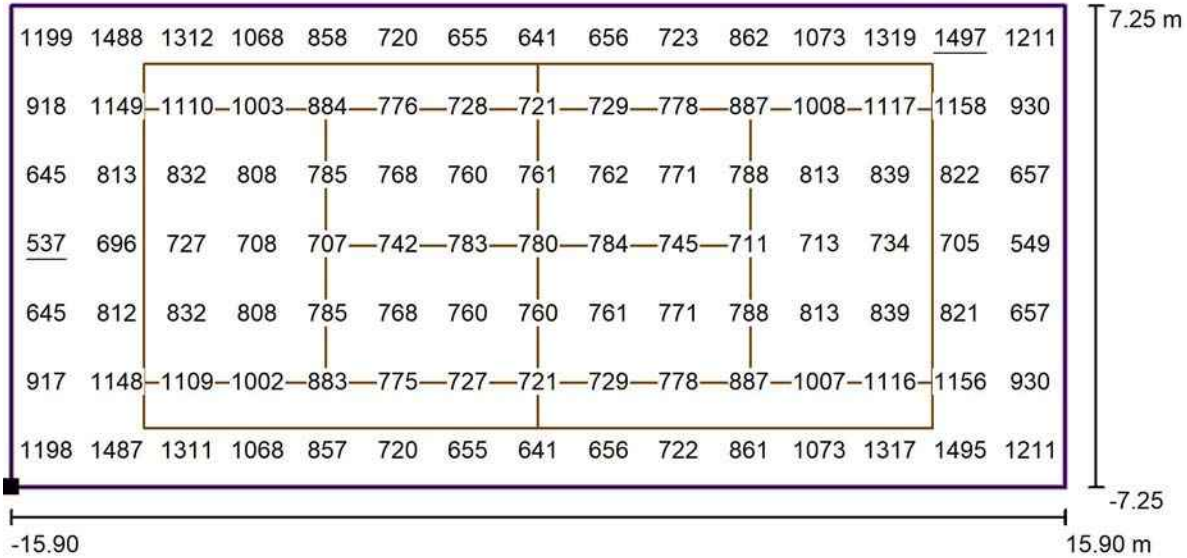

Values in Lux, Scale 1 : 228

Position of surface in external scene:
 Marked point: (21.820 m, -15.900 m, 0.000 m)

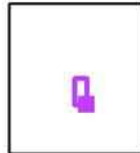

Grid: 15 x 7 Points

E_{av} [lx]	E_{min} [lx]	E_{max} [lx]	u0	E_{min} / E_{max}
878	537	1497	0.61	0.36

MIDSTREAM LIGHTING LIMITED
 WESSEX HOUSE
 1 CHESHAM STREET
 LONDON, SW 1X 8ND, UNITED KINGDOM

Operator MIDSTREAM LIGHTING LIMITED
 Telephone +44 (0)207 584 8310
 Fax
 e-Mail info@midstreamlighting.com

ALL ON / Tennis 2 Calculation Grid (PPA) / Summary

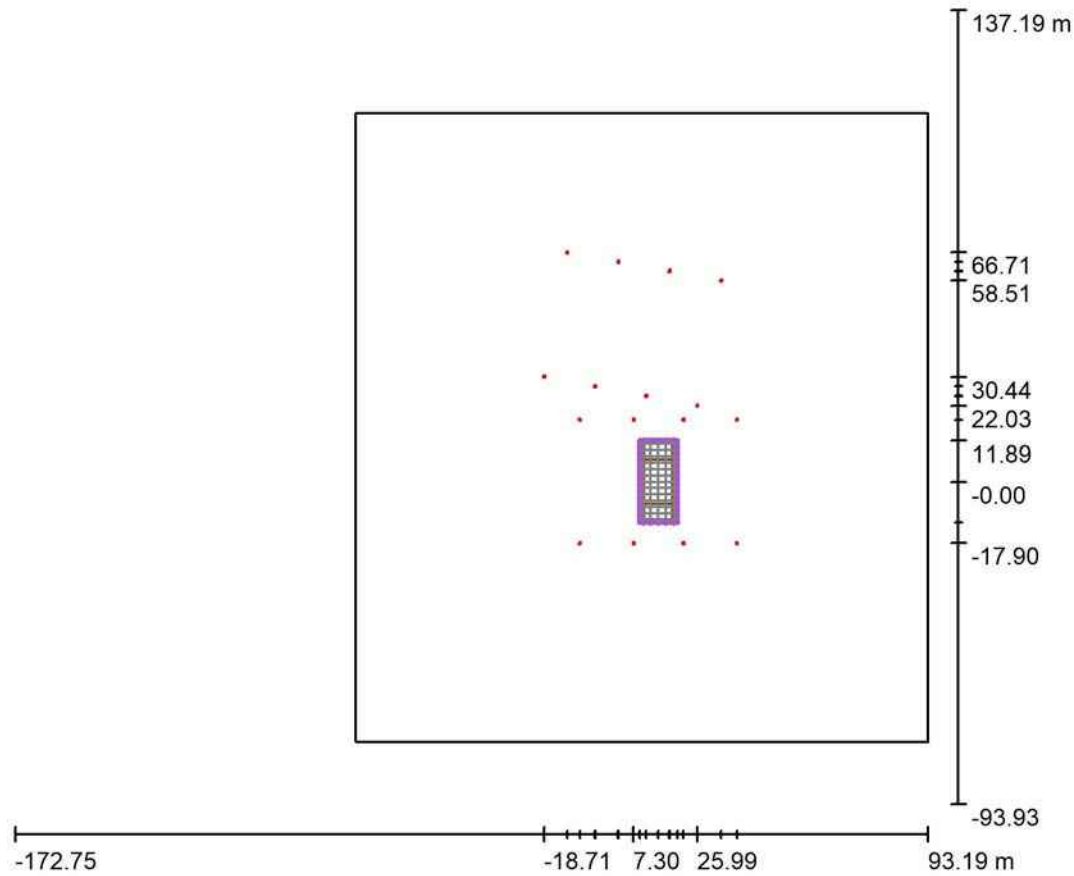

Scale 1 : 2204

Position: (14.580 m, 0.000 m, 0.000 m)
 Size: (23.780 m, 10.970 m)
 Rotation: (0.0°, 0.0°, 90.0°)
 Type: Normal, Grid: 13 x 5 Points
 Belongs to the following sport arena: Tennis 2

Results overview

No.	Type	E_{av} [lx]	E_{min} [lx]	E_{max} [lx]	u0	E_{min} / E_{max}	$E_{h\ m} / E_m$	H [m]	Camera
1	horizontal	826	703	1168	0.85	0.60	/	0.000	/

$E_{h\ m} / E_m$ = Relationship between middle horizontal and vertical illuminance, H = Measuring Height

MIDSTREAM LIGHTING LIMITED
 WESSEX HOUSE
 1 CHESHAM STREET
 LONDON, SW 1X 8ND, UNITED KINGDOM

Operator MIDSTREAM LIGHTING LIMITED
 Telephone +44 (0)207 584 8310
 Fax
 e-Mail info@midstreamlighting.com

ALL ON / Tennis 2 Calculation Grid (PPA) / Value Chart (E, Horizontal)

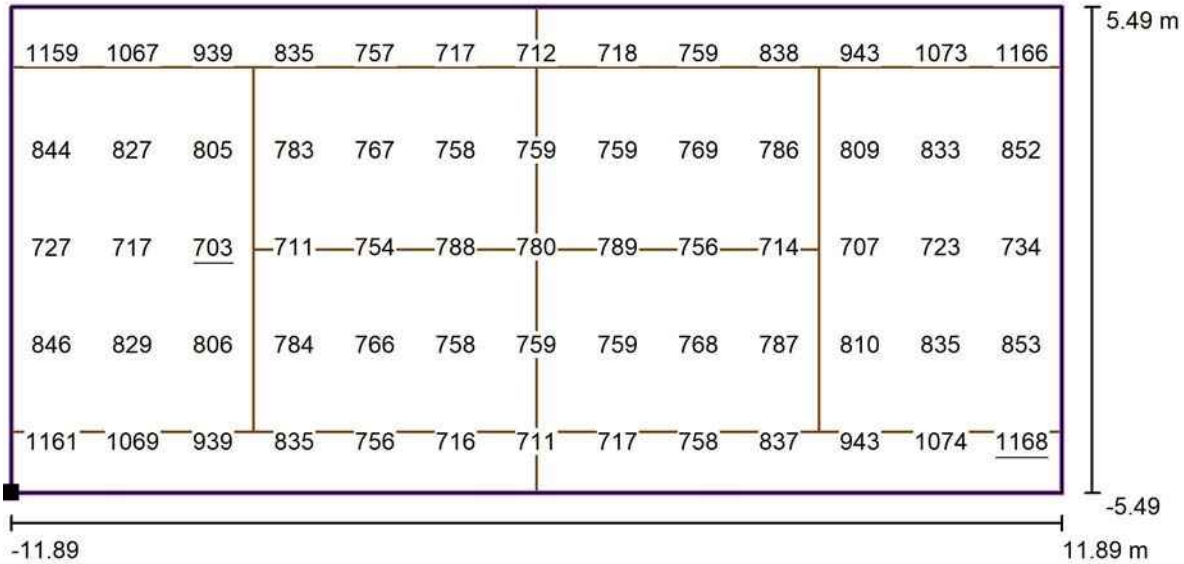

Values in Lux, Scale 1 : 171

Position of surface in external scene:
 Marked point: (20.065 m, -11.890 m,
 0.000 m)



Grid: 13 x 5 Points

E_{av} [lx]	E_{min} [lx]	E_{max} [lx]	$u0$	E_{min} / E_{max}
826	703	1168	0.85	0.60

MIDSTREAM LIGHTING LIMITED
 WESSEX HOUSE
 1 CHESHAM STREET
 LONDON, SW 1X 8ND, UNITED KINGDOM

Operator MIDSTREAM LIGHTING LIMITED
 Telephone +44 (0)207 584 8310
 Fax
 e-Mail info@midstreamlighting.com

ALL ON / Tennis 3 Calculation Grid (TPA) / Summary

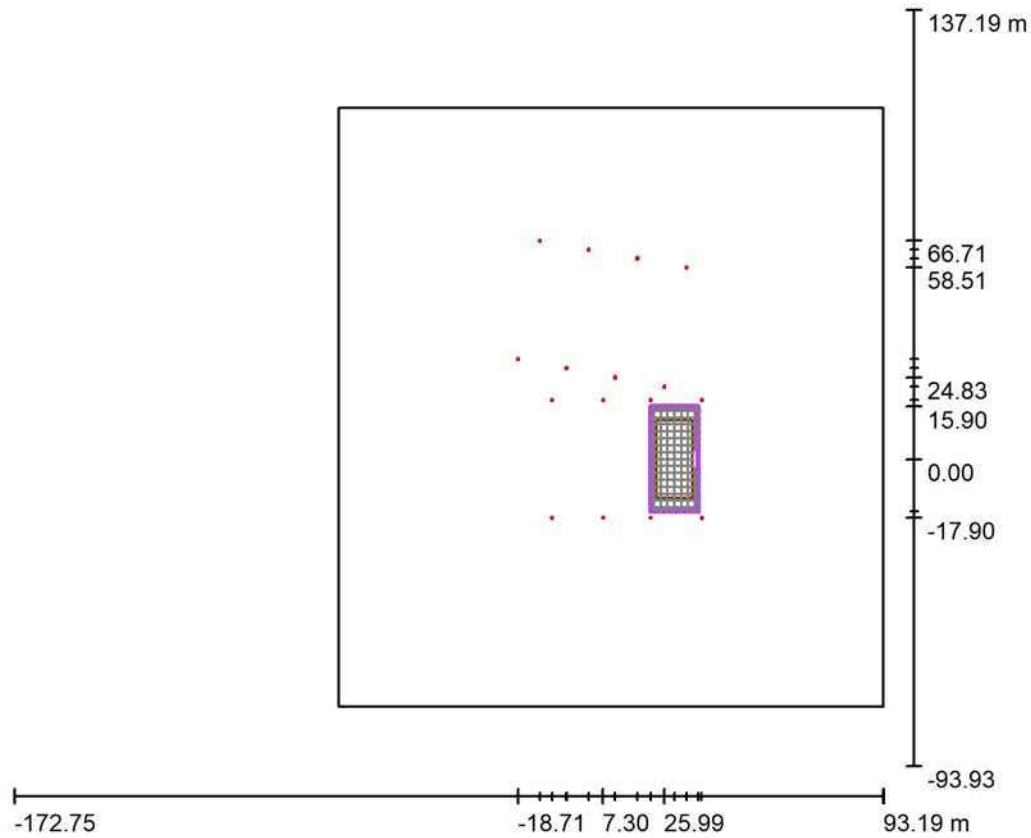

Scale 1 : 2314

Position: (29.180 m, 0.000 m, 0.000 m)
 Size: (31.800 m, 14.500 m)
 Rotation: (0.0°, 0.0°, 90.0°)
 Type: User defined, Quantity Points: 102
 Belongs to the following sport arena: Tennis 3

Results overview

No.	Type	E_{av} [lx]	E_{min} [lx]	E_{max} [lx]	u0	E_{min} / E_{max}	$E_{h\ m} / E_m$	H [m]	Camera
1	horizontal	747	451	1493	0.60	0.30	/	0.000	/

$E_{h\ m} / E_m$ = Relationship between middle horizontal and vertical illuminance, H = Measuring Height

MIDSTREAM LIGHTING LIMITED
 WESSEX HOUSE
 1 CHESHAM STREET
 LONDON, SW 1X 8ND, UNITED KINGDOM

Operator MIDSTREAM LIGHTING LIMITED
 Telephone +44 (0)207 584 8310
 Fax
 e-Mail info@midstreamlighting.com

ALL ON / Tennis 3 Calculation Grid (TPA) / Value Chart (E, Horizontal)

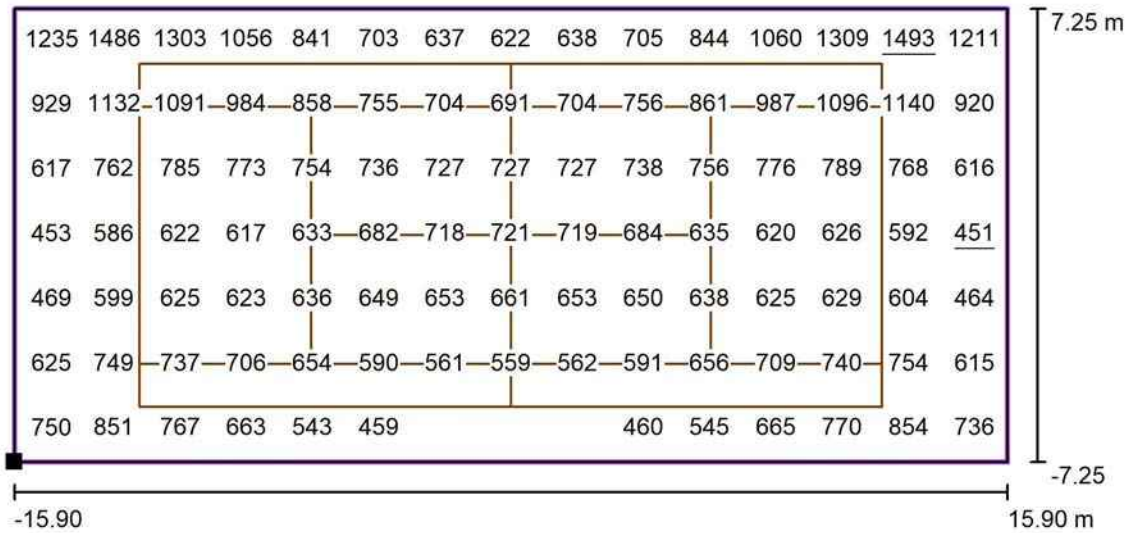

Values in Lux, Scale 1 : 242

Position of surface in external scene:
 Marked point: (36.430 m, -15.900 m, 0.000 m)

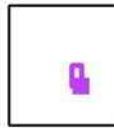

Grid: 102 Points

E_{av} [lx]
747

E_{min} [lx]
451

E_{max} [lx]
1493

u_0
0.60

E_{min} / E_{max}
0.30

MIDSTREAM LIGHTING LIMITED
 WESSEX HOUSE
 1 CHESHAM STREET
 LONDON, SW 1X 8ND, UNITED KINGDOM

Operator MIDSTREAM LIGHTING LIMITED
 Telephone +44 (0)207 584 8310
 Fax
 e-Mail info@midstreamlighting.com

ALL ON / Tennis 3 Calculation Grid (PPA) / Summary

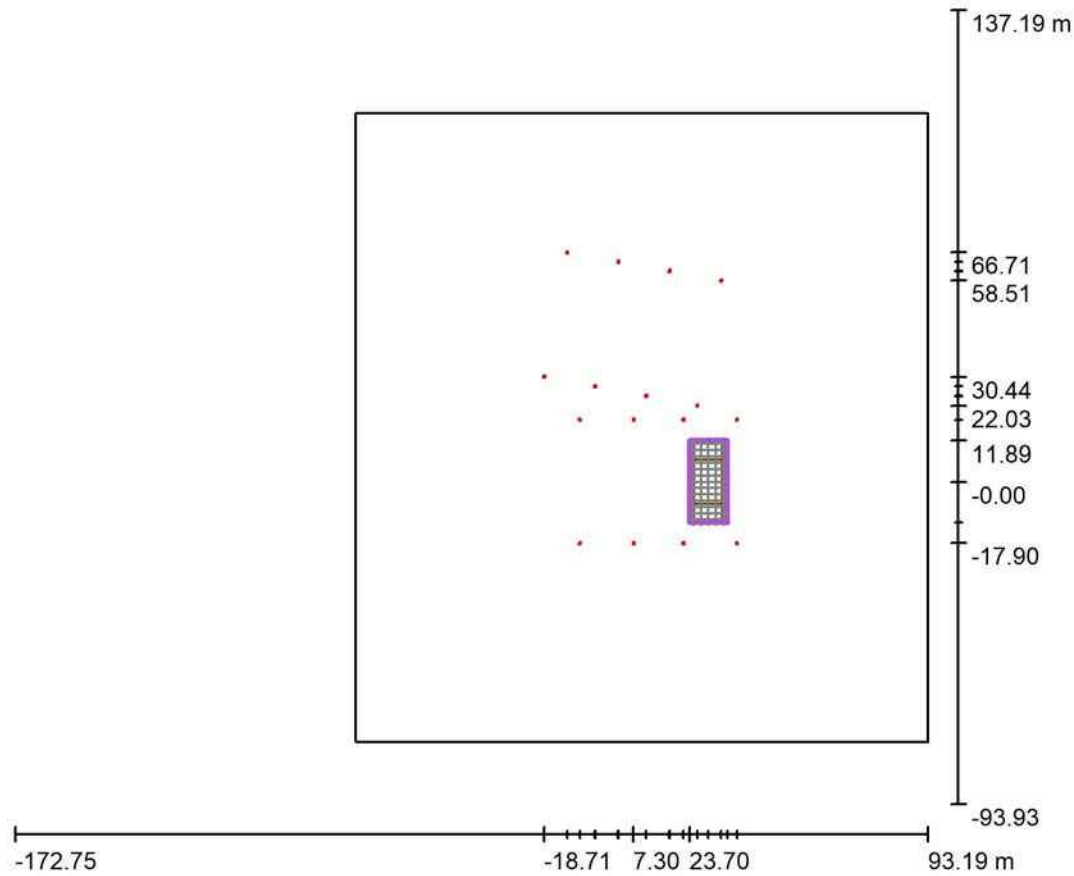

Scale 1 : 2204

Position: (29.190 m, 0.000 m, 0.000 m)
 Size: (23.780 m, 10.970 m)
 Rotation: (0.0°, 0.0°, 90.0°)
 Type: Normal, Grid: 13 x 5 Points
 Belongs to the following sport arena: Tennis 3

Results overview

No.	Type	E_{av} [lx]	E_{min} [lx]	E_{max} [lx]	u0	E_{min} / E_{max}	$E_{h\ m} / E_m$	H [m]	Camera
1	horizontal	716	542	1148	0.76	0.47	/	0.000	/

$E_{h\ m} / E_m$ = Relationship between middle horizontal and vertical illuminance, H = Measuring Height

MIDSTREAM LIGHTING LIMITED
 WESSEX HOUSE
 1 CHESHAM STREET
 LONDON, SW 1X 8ND, UNITED KINGDOM

Operator MIDSTREAM LIGHTING LIMITED
 Telephone +44 (0)207 584 8310
 Fax
 e-Mail info@midstreamlighting.com

ALL ON / Tennis 3 Calculation Grid (PPA) / Value Chart (E, Horizontal)

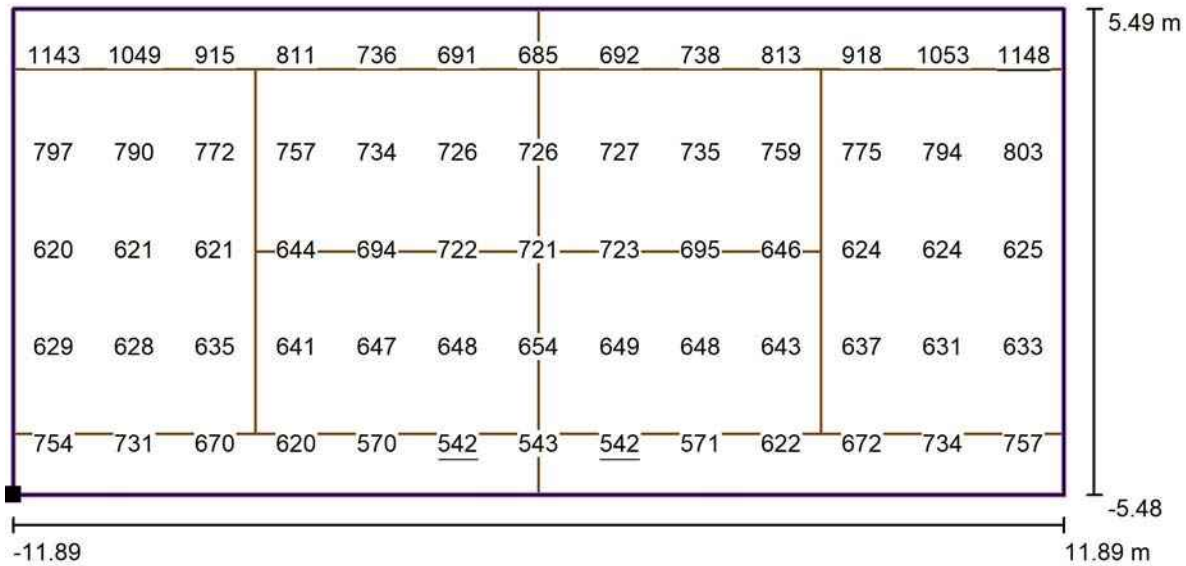

Values in Lux, Scale 1 : 171

Position of surface in external scene:
 Marked point: (34.675 m, -11.890 m,
 0.000 m)

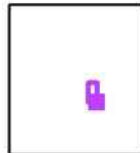

Grid: 13 x 5 Points

E_{av} [lx]	E_{min} [lx]	E_{max} [lx]	u0	E_{min} / E_{max}
716	542	1148	0.76	0.47

MIDSTREAM LIGHTING LIMITED
 WESSEX HOUSE
 1 CHESHAM STREET
 LONDON, SW 1X 8ND, UNITED KINGDOM

Operator MIDSTREAM LIGHTING LIMITED
 Telephone +44 (0)207 584 8310
 Fax
 e-Mail info@midstreamlighting.com

ALL ON / Tennis 4 Calculation Grid (TPA) / Summary

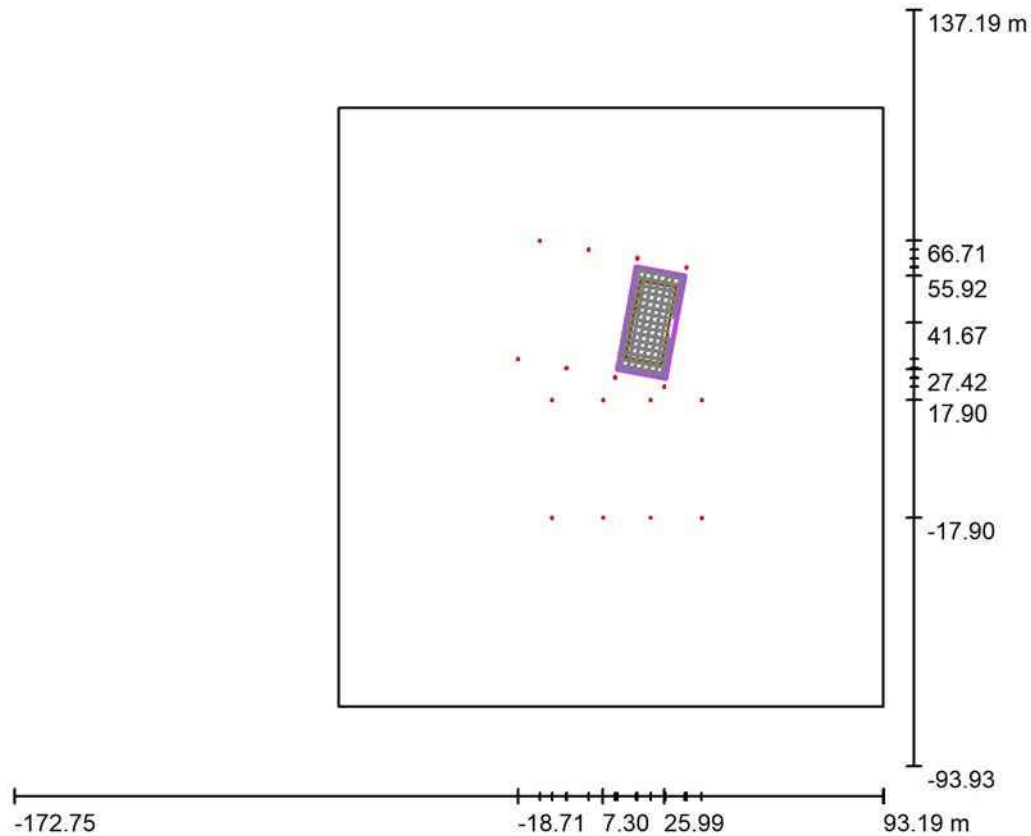

Scale 1 : 2314

Position: (21.934 m, 41.667 m, 0.000 m)
 Size: (31.800 m, 15.000 m)
 Rotation: (0.0°, 0.0°, 79.4°)
 Type: User defined, Quantity Points: 102
 Belongs to the following sport arena: Tennis 4

Results overview

No.	Type	E_{av} [lx]	E_{min} [lx]	E_{max} [lx]	u0	E_{min} / E_{max}	$E_{h\ m} / E_m$	H [m]	Camera
1	horizontal	710	429	1437	0.60	0.30	/	0.000	/

$E_{h\ m} / E_m$ = Relationship between middle horizontal and vertical illuminance, H = Measuring Height

MIDSTREAM LIGHTING LIMITED
 WESSEX HOUSE
 1 CHESHAM STREET
 LONDON, SW 1X 8ND, UNITED KINGDOM

Operator MIDSTREAM LIGHTING LIMITED
 Telephone +44 (0)207 584 8310
 Fax
 e-Mail info@midstreamlighting.com

ALL ON / Tennis 4 Calculation Grid (TPA) / Value Chart (E, Horizontal)

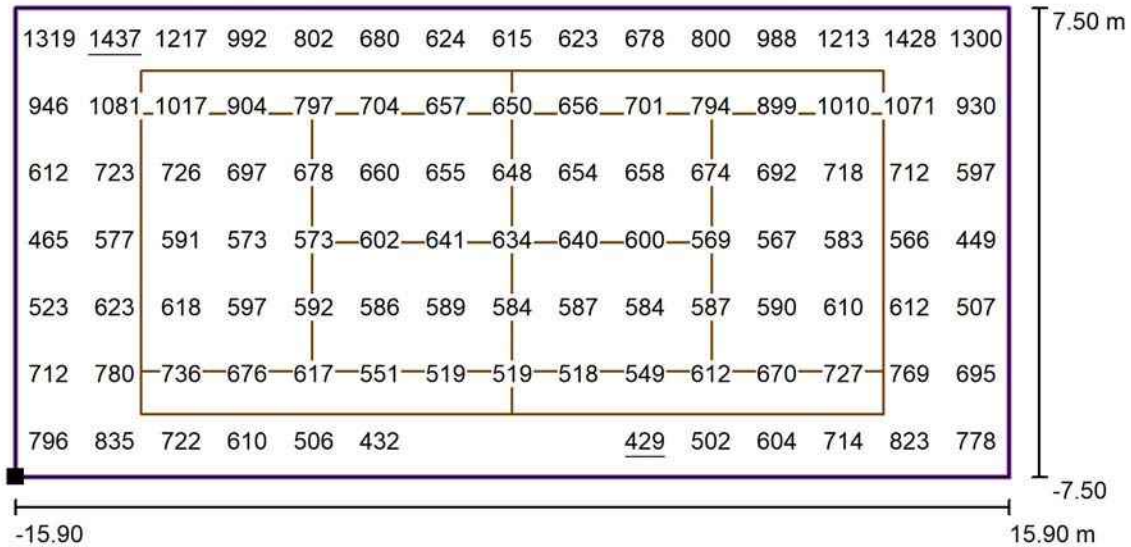

Values in Lux, Scale 1 : 242

Position of surface in external scene:
 Marked point: (26.381 m, 24.659 m,
 0.000 m)



Grid: 102 Points

E_{av} [lx]	E_{min} [lx]	E_{max} [lx]	u0	E_{min} / E_{max}
710	429	1437	0.60	0.30

MIDSTREAM LIGHTING LIMITED
 WESSEX HOUSE
 1 CHESHAM STREET
 LONDON, SW 1X 8ND, UNITED KINGDOM

Operator MIDSTREAM LIGHTING LIMITED
 Telephone +44 (0)207 584 8310
 Fax
 e-Mail info@midstreamlighting.com

ALL ON / Tennis 4 Calculation Grid (PPA) / Summary

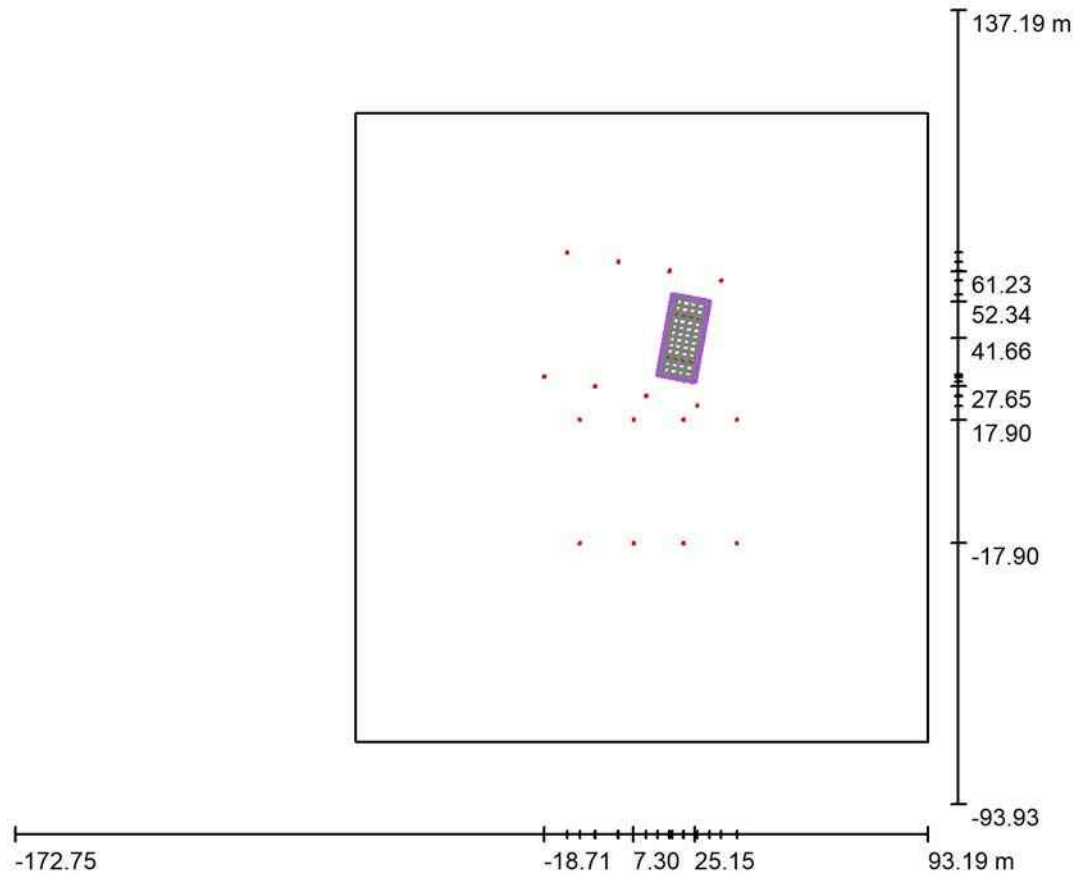

Scale 1 : 2204

Position: (21.944 m, 41.665 m, 0.000 m)
 Size: (23.780 m, 10.970 m)
 Rotation: (0.0°, 0.0°, 79.4°)
 Type: Normal, Grid: 13 x 5 Points
 Belongs to the following sport arena: Tennis 4

Results overview

No.	Type	E_{av} [lx]	E_{min} [lx]	E_{max} [lx]	u0	E_{min} / E_{max}	$E_{h\ m} / E_m$	H [m]	Camera
1	horizontal	658	511	1044	0.78	0.49	/	0.000	/

$E_{h\ m} / E_m$ = Relationship between middle horizontal and vertical illuminance, H = Measuring Height

MIDSTREAM LIGHTING LIMITED
 WESSEX HOUSE
 1 CHESHAM STREET
 LONDON, SW 1X 8ND, UNITED KINGDOM

Operator MIDSTREAM LIGHTING LIMITED
 Telephone +44 (0)207 584 8310
 Fax
 e-Mail info@midstreamlighting.com

ALL ON / Tennis 4 Calculation Grid (PPA) / Value Chart (E, Horizontal)

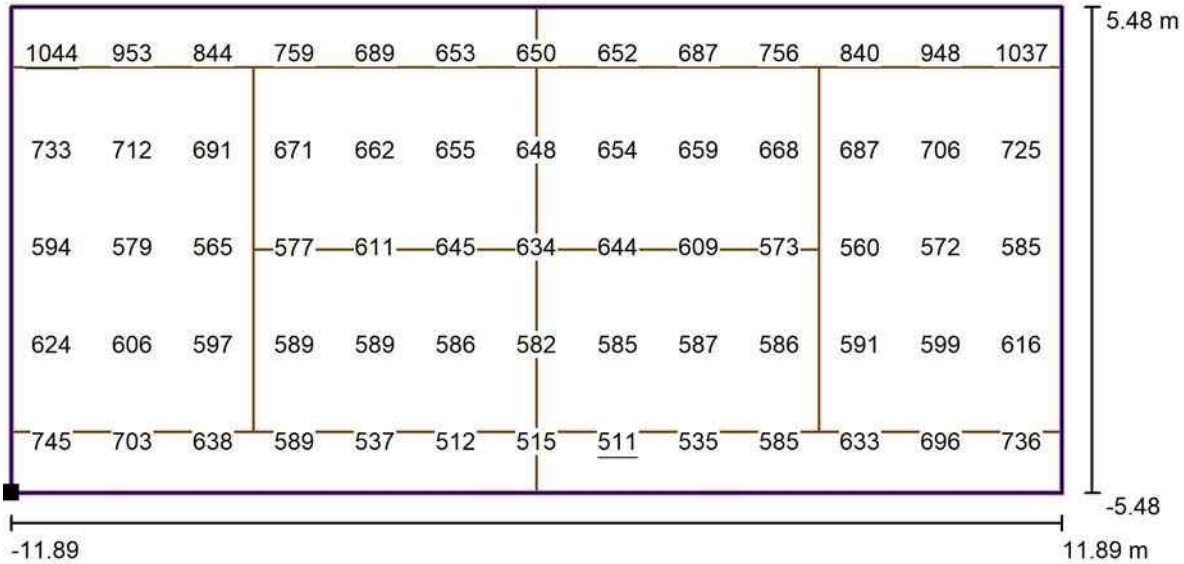

Values in Lux, Scale 1 : 171

Position of surface in external scene:
 Marked point: (25.148 m, 28.969 m,
 0.000 m)



Grid: 13 x 5 Points

E_{av} [lx]
658

E_{min} [lx]
511

E_{max} [lx]
1044

$u0$
0.78

E_{min} / E_{max}
0.49

MIDSTREAM LIGHTING LIMITED
 WESSEX HOUSE
 1 CHESHAM STREET
 LONDON, SW 1X 8ND, UNITED KINGDOM

Operator MIDSTREAM LIGHTING LIMITED
 Telephone +44 (0)207 584 8310
 Fax
 e-Mail info@midstreamlighting.com

ALL ON / Tennis 5 Calculation Grid (TPA) / Summary

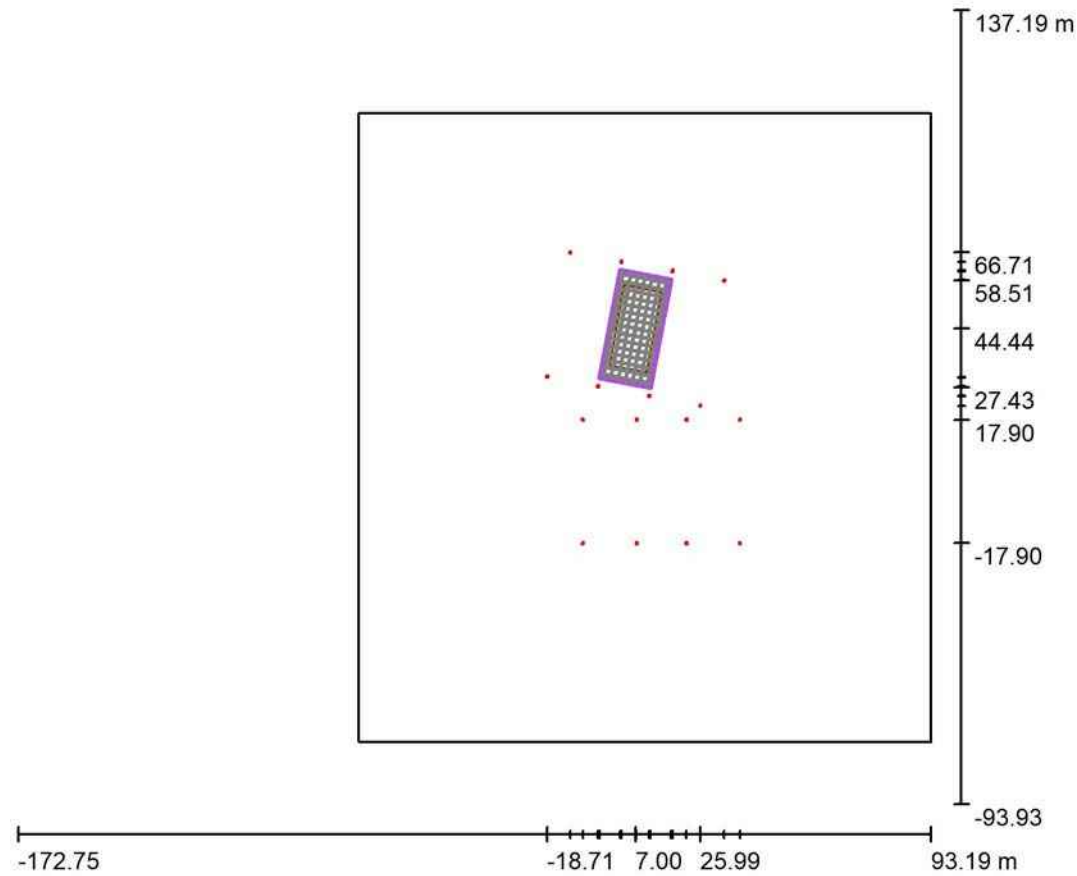

Scale 1 : 2204

Position: (6.998 m, 44.436 m, 0.000 m)
 Size: (31.800 m, 15.000 m)
 Rotation: (0.0°, 0.0°, 79.4°)
 Type: Normal, Grid: 15 x 7 Points
 Belongs to the following sport arena: Tennis 5

Results overview

No.	Type	E_{av} [lx]	E_{min} [lx]	E_{max} [lx]	u0	E_{min} / E_{max}	$E_{h\ m} / E_m$	H [m]	Camera
1	horizontal	831	523	1450	0.63	0.36	/	0.000	/

$E_{h\ m} / E_m$ = Relationship between middle horizontal and vertical illuminance, H = Measuring Height

MIDSTREAM LIGHTING LIMITED
 WESSEX HOUSE
 1 CHESHAM STREET
 LONDON, SW 1X 8ND, UNITED KINGDOM

Operator MIDSTREAM LIGHTING LIMITED
 Telephone +44 (0)207 584 8310
 Fax
 e-Mail info@midstreamlighting.com

ALL ON / Tennis 5 Calculation Grid (TPA) / Value Chart (E, Horizontal)

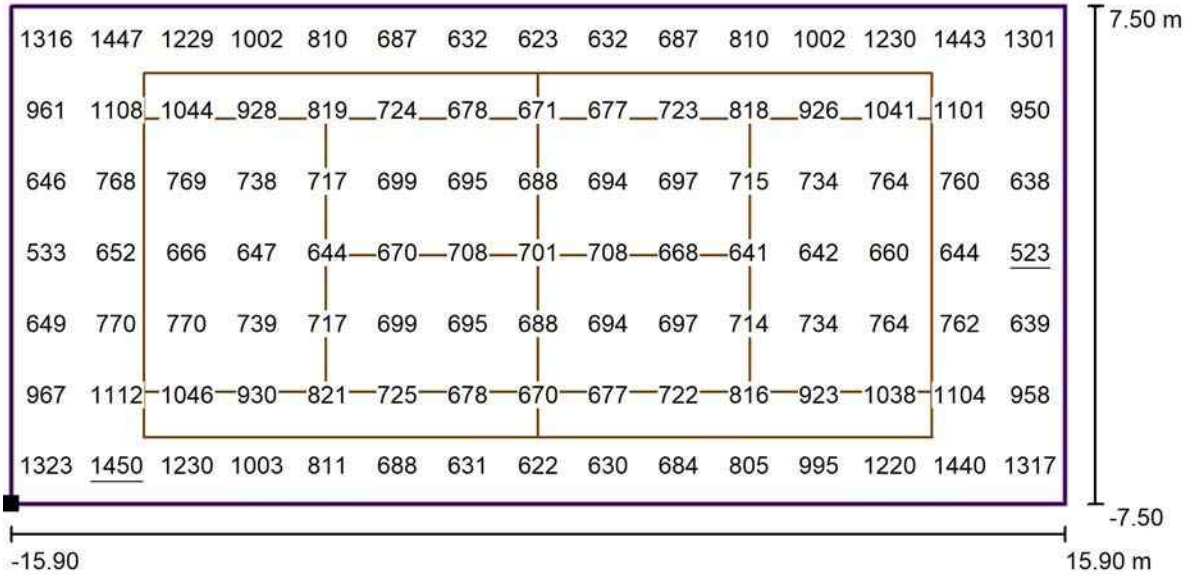

Values in Lux, Scale 1 : 228

Position of surface in external scene:
 Marked point: (11.445 m, 27.428 m,
 0.000 m)



Grid: 15 x 7 Points

E_{av} [lx]	E_{min} [lx]	E_{max} [lx]	u0	E_{min} / E_{max}
831	523	1450	0.63	0.36

MIDSTREAM LIGHTING LIMITED
 WESSEX HOUSE
 1 CHESHAM STREET
 LONDON, SW 1X 8ND, UNITED KINGDOM

Operator MIDSTREAM LIGHTING LIMITED
 Telephone +44 (0)207 584 8310
 Fax
 e-Mail info@midstreamlighting.com

ALL ON / Tennis 5 Calculation Grid (PPA) / Summary

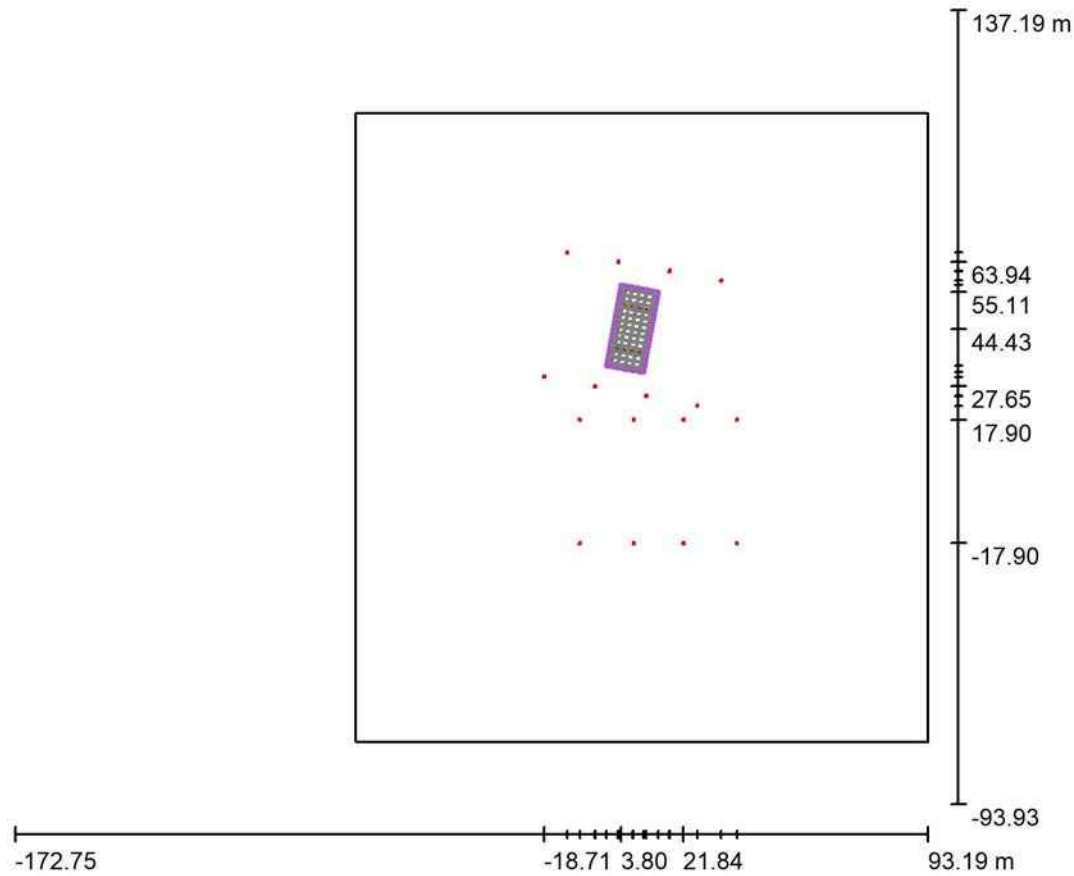

Scale 1 : 2204

Position: (7.008 m, 44.434 m, 0.000 m)
 Size: (23.780 m, 10.970 m)
 Rotation: (0.0°, 0.0°, 79.4°)
 Type: Normal, Grid: 13 x 5 Points
 Belongs to the following sport arena: Tennis 5

Results overview

No.	Type	E_{av} [lx]	E_{min} [lx]	E_{max} [lx]	$u0$	E_{min} / E_{max}	$E_{h\ m} / E_m$	H [m]	Camera
1	horizontal	756	633	1076	0.84	0.59	/	0.000	/

$E_{h\ m} / E_m$ = Relationship between middle horizontal and vertical illuminance, H = Measuring Height

MIDSTREAM LIGHTING LIMITED
 WESSEX HOUSE
 1 CHESHAM STREET
 LONDON, SW 1X 8ND, UNITED KINGDOM

Operator MIDSTREAM LIGHTING LIMITED
 Telephone +44 (0)207 584 8310
 Fax
 e-Mail info@midstreamlighting.com

ALL ON / Tennis 5 Calculation Grid (PPA) / Value Chart (E, Horizontal)

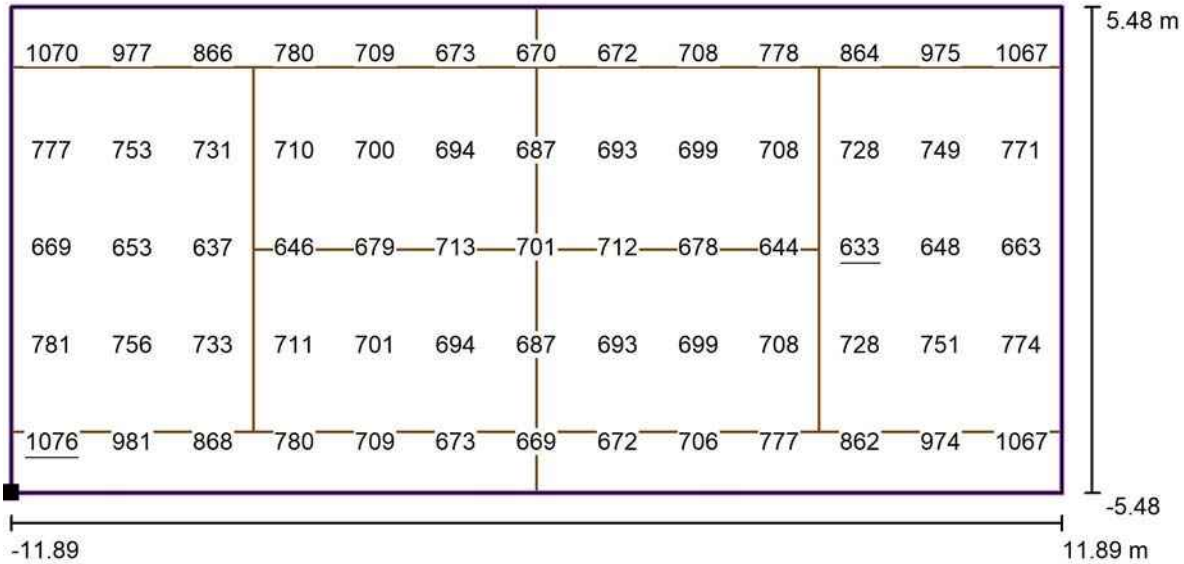

Values in Lux, Scale 1 : 171

Position of surface in external scene:
 Marked point: (10.212 m, 31.738 m,
 0.000 m)



Grid: 13 x 5 Points

E_{av} [lx]	E_{min} [lx]	E_{max} [lx]	$u0$	E_{min} / E_{max}
756	633	1076	0.84	0.59

MIDSTREAM LIGHTING LIMITED
 WESSEX HOUSE
 1 CHESHAM STREET
 LONDON, SW 1X 8ND, UNITED KINGDOM

Operator MIDSTREAM LIGHTING LIMITED
 Telephone +44 (0)207 584 8310
 Fax
 e-Mail info@midstreamlighting.com

ALL ON / Tennis 6 Calculation Grid (TPA) / Summary

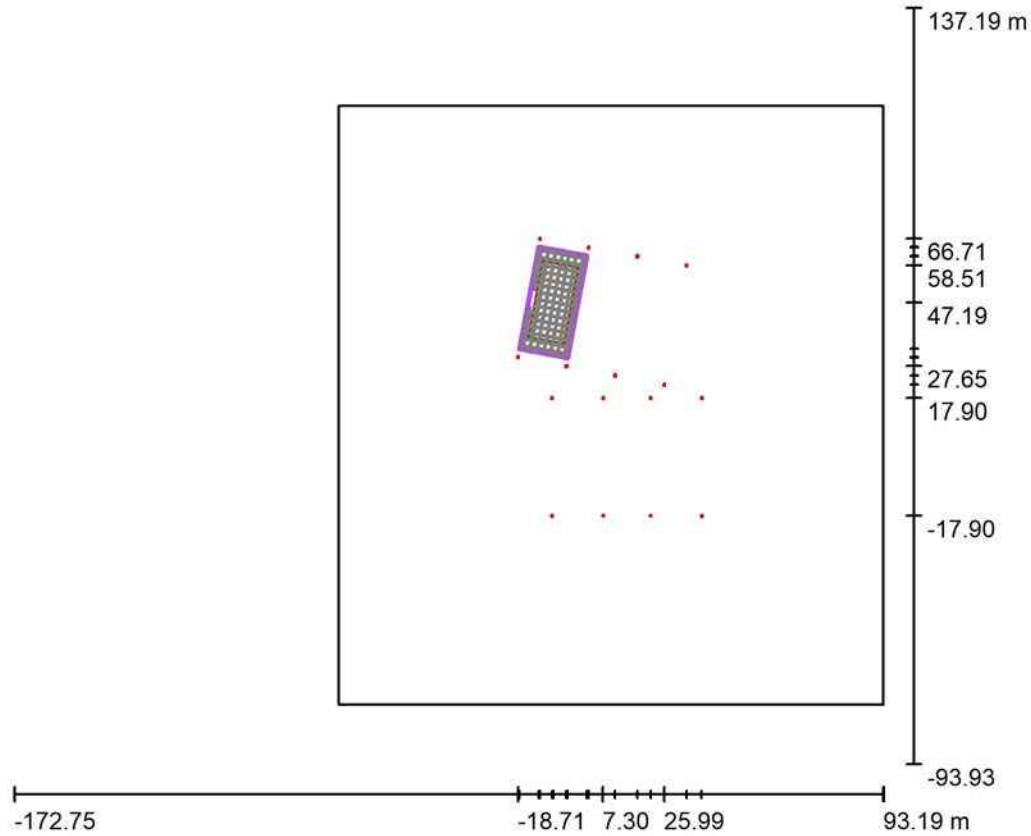

Scale 1 : 2314

Position: (-7.919 m, 47.189 m, 0.000 m)
 Size: (31.800 m, 15.000 m)
 Rotation: (0.0°, 0.0°, 79.4°)
 Type: User defined, Quantity Points: 102
 Belongs to the following sport arena: Tennis 6

Results overview

No.	Type	E_{av} [lx]	E_{min} [lx]	E_{max} [lx]	u0	E_{min} / E_{max}	$E_{h\ m} / E_m$	H [m]	Camera
1	horizontal	714	432	1444	0.60	0.30	/	0.000	/

$E_{h\ m} / E_m$ = Relationship between middle horizontal and vertical illuminance, H = Measuring Height

MIDSTREAM LIGHTING LIMITED
 WESSEX HOUSE
 1 CHESHAM STREET
 LONDON, SW 1X 8ND, UNITED KINGDOM

Operator MIDSTREAM LIGHTING LIMITED
 Telephone +44 (0)207 584 8310
 Fax
 e-Mail info@midstreamlighting.com

ALL ON / Tennis 6 Calculation Grid (TPA) / Value Chart (E, Horizontal)

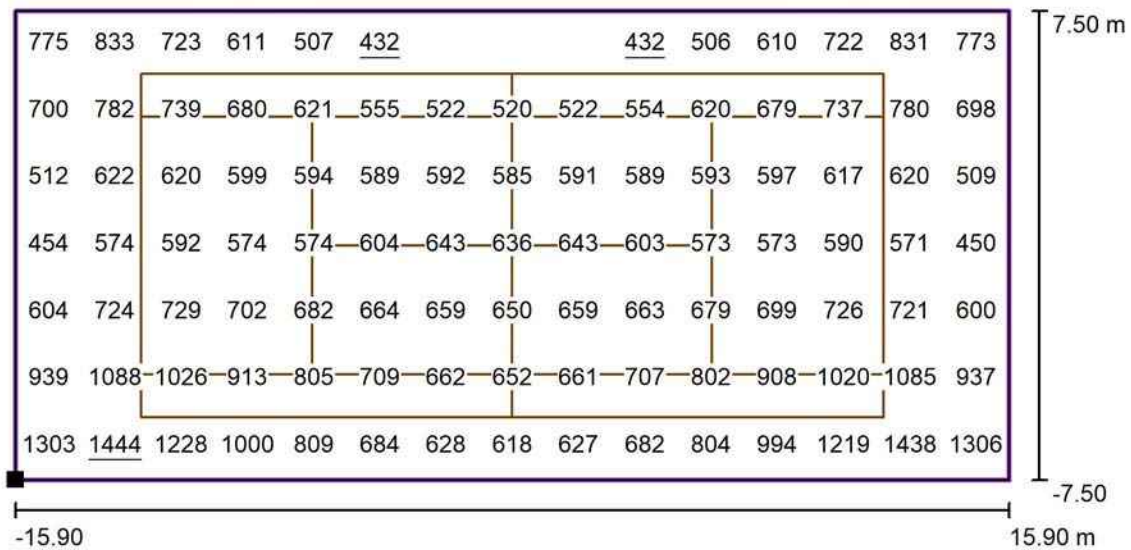

Values in Lux, Scale 1 : 242

Position of surface in external scene:
 Marked point: (-3.472 m, 30.181 m,
 0.000 m)



Grid: 102 Points

E_{av} [lx]	E_{min} [lx]	E_{max} [lx]	u0	E_{min} / E_{max}
714	432	1444	0.60	0.30

MIDSTREAM LIGHTING LIMITED
 WESSEX HOUSE
 1 CHESHAM STREET
 LONDON, SW 1X 8ND, UNITED KINGDOM

Operator MIDSTREAM LIGHTING LIMITED
 Telephone +44 (0)207 584 8310
 Fax
 e-Mail info@midstreamlighting.com

ALL ON / Tennis 6 Calculation Grid (PPA) / Summary

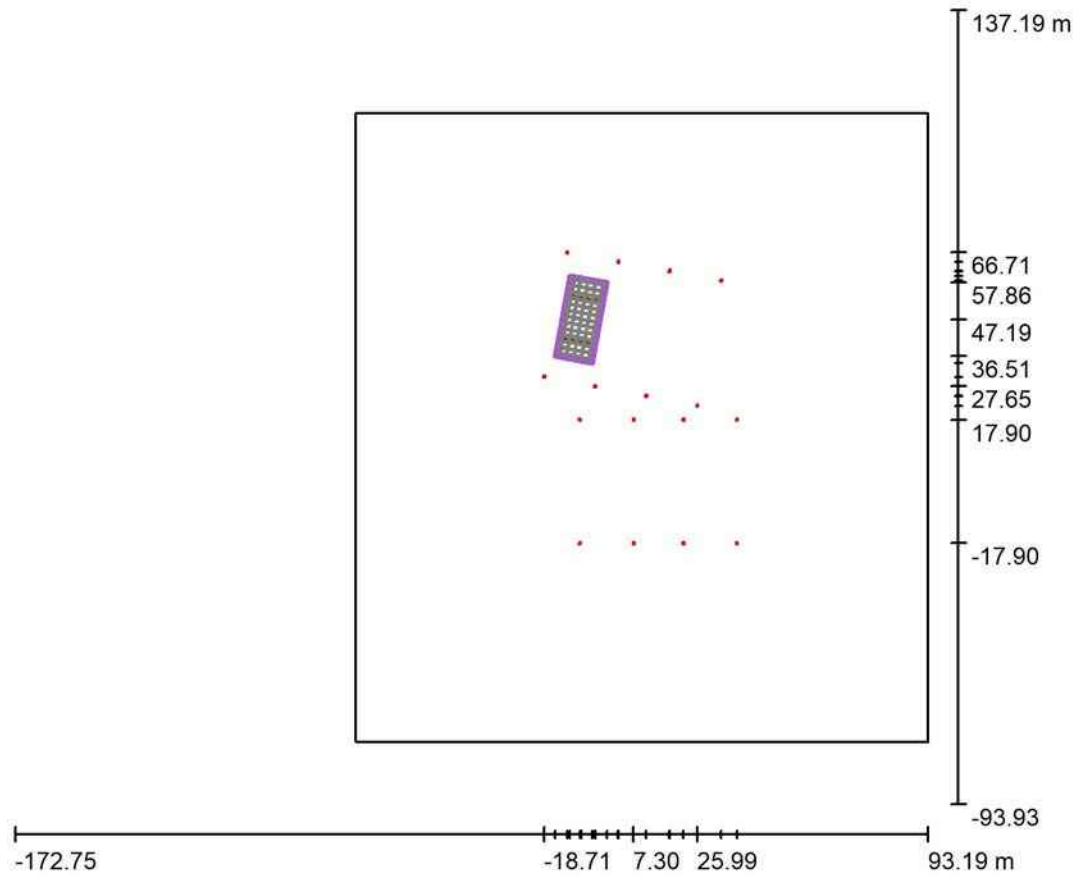

Scale 1 : 2204

Position: (-7.909 m, 47.187 m, 0.000 m)
 Size: (23.780 m, 10.970 m)
 Rotation: (0.0°, 0.0°, 79.4°)
 Type: Normal, Grid: 13 x 5 Points
 Belongs to the following sport arena: Tennis 6

Results overview

No.	Type	E_{av} [lx]	E_{min} [lx]	E_{max} [lx]	u0	E_{min} / E_{max}	$E_{h\ m} / E_m$	H [m]	Camera
1	horizontal	664	515	1056	0.78	0.49	/	0.000	/

$E_{h\ m} / E_m$ = Relationship between middle horizontal and vertical illuminance, H = Measuring Height

MIDSTREAM LIGHTING LIMITED
 WESSEX HOUSE
 1 CHESHAM STREET
 LONDON, SW 1X 8ND, UNITED KINGDOM

Operator MIDSTREAM LIGHTING LIMITED
 Telephone +44 (0)207 584 8310
 Fax
 e-Mail info@midstreamlighting.com

ALL ON / Tennis 6 Calculation Grid (PPA) / Value Chart (E, Horizontal)

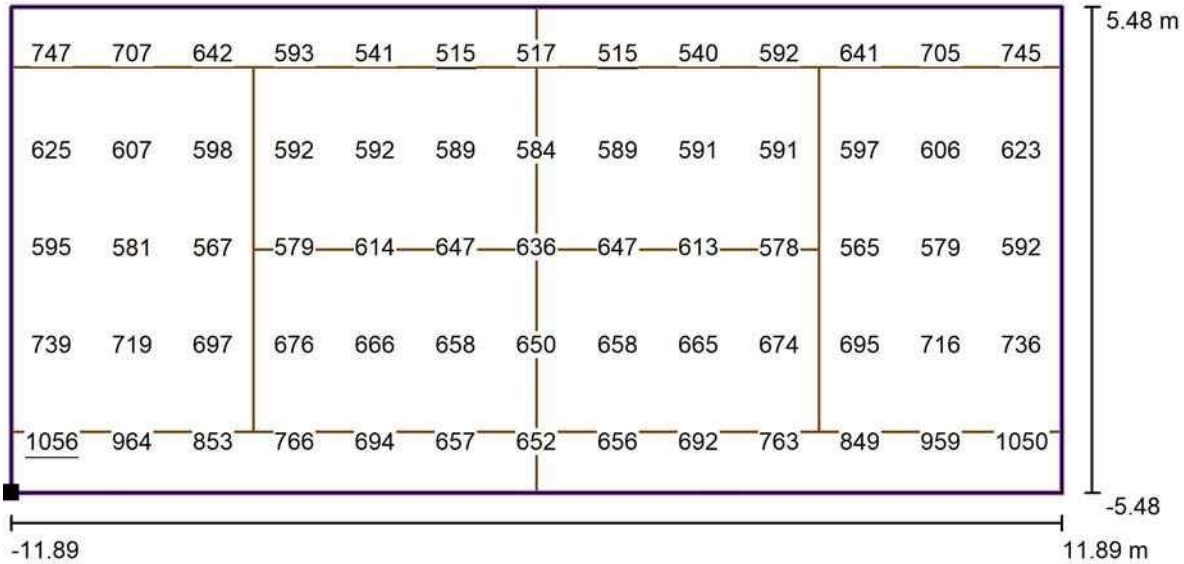

Values in Lux, Scale 1 : 171

Position of surface in external scene:
 Marked point: (-4.705 m, 34.491 m,
 0.000 m)



Grid: 13 x 5 Points

E_{av} [lx]
664

E_{min} [lx]
515

E_{max} [lx]
1056

u_0
0.78

E_{min} / E_{max}
0.49

MIDSTREAM LIGHTING LIMITED
 WESSEX HOUSE
 1 CHESHAM STREET
 LONDON, SW 1X 8ND, UNITED KINGDOM

Operator MIDSTREAM LIGHTING LIMITED
 Telephone +44 (0)207 584 8310
 Fax
 e-Mail info@midstreamlighting.com

ALL ON / Spill Out - House 1 / Table (E, Perpendicular)



Position of surface in external scene:
 Marked point: (34.061 m, 137.195 m,
 0.000 m)

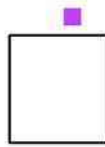

1.000 1.34

0.000 1.54

m 5.000

Attention: The coordinates refer to the image above. Values in Lux.

Grid: 1 x 2 Points

E_{av} [lx]
1.44

E_{min} [lx]
1.34

E_{max} [lx]
1.54

$u0$
0.93

E_{min} / E_{max}
0.87

MIDSTREAM LIGHTING LIMITED
 WESSEX HOUSE
 1 CHESHAM STREET
 LONDON, SW 1X 8ND, UNITED KINGDOM

Operator MIDSTREAM LIGHTING LIMITED
 Telephone +44 (0)207 584 8310
 Fax
 e-Mail info@midstreamlighting.com

ALL ON / Spill Out - House 2 / Table (E, Perpendicular)



Position of surface in external scene:
 Marked point: (36.721 m, 108.534 m,
 0.000 m)

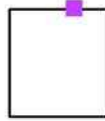

1.000 4.38

0.000 4.78

m 5.000

Attention: The coordinates refer to the image above. Values in Lux.

Grid: 1 x 2 Points

E_{av} [lx]	E_{min} [lx]	E_{max} [lx]	$u0$	E_{min} / E_{max}
4.58	4.38	4.78	0.96	0.92

MIDSTREAM LIGHTING LIMITED
 WESSEX HOUSE
 1 CHESHAM STREET
 LONDON, SW 1X 8ND, UNITED KINGDOM

Operator MIDSTREAM LIGHTING LIMITED
 Telephone +44 (0)207 584 8310
 Fax
 e-Mail info@midstreamlighting.com

ALL ON / Spill Out - House 3 / Table (E, Perpendicular)



Position of surface in external scene:
 Marked point: (37.913 m, 92.603 m,
 0.000 m)



1.000 8.88

0.000 9.59

m **4.000**

Attention: The coordinates refer to the image above. Values in Lux.

Grid: 1 x 2 Points

E_{av} [lx]	E_{min} [lx]	E_{max} [lx]	u0	E_{min} / E_{max}
9.23	8.88	9.59	0.96	0.93

MIDSTREAM LIGHTING LIMITED
 WESSEX HOUSE
 1 CHESHAM STREET
 LONDON, SW 1X 8ND, UNITED KINGDOM

Operator MIDSTREAM LIGHTING LIMITED
 Telephone +44 (0)207 584 8310
 Fax
 e-Mail info@midstreamlighting.com

ALL ON / Spill Out - House 4 / Table (E, Perpendicular)



Position of surface in external scene:
 Marked point: (38.283 m, 82.245 m,
 0.000 m)



1.000 16
0.000 16
 m **5.000**

Attention: The coordinates refer to the image above. Values in Lux.

Grid: 1 x 2 Points

E_{av} [lx]	E_{min} [lx]	E_{max} [lx]	u0	E_{min} / E_{max}
16	16	16	0.99	0.97

MIDSTREAM LIGHTING LIMITED
 WESSEX HOUSE
 1 CHESHAM STREET
 LONDON, SW 1X 8ND, UNITED KINGDOM

Operator MIDSTREAM LIGHTING LIMITED
 Telephone +44 (0)207 584 8310
 Fax
 e-Mail info@midstreamlighting.com

ALL ON / Spill Out - House 5 / Table (E, Perpendicular)



Position of surface in external scene:
 Marked point: (37.686 m, 69.706 m,
 0.000 m)

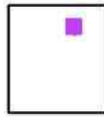

1.000 35

0.000 33

m 5.000

Attention: The coordinates refer to the image above. Values in Lux.

Grid: 1 x 2 Points

E_{av} [lx]
34

E_{min} [lx]
33

E_{max} [lx]
35

$u0$
0.96

E_{min} / E_{max}
0.93

MIDSTREAM LIGHTING LIMITED
 WESSEX HOUSE
 1 CHESHAM STREET
 LONDON, SW 1X 8ND, UNITED KINGDOM

Operator MIDSTREAM LIGHTING LIMITED
 Telephone +44 (0)207 584 8310
 Fax
 e-Mail info@midstreamlighting.com

ALL ON / Spill Out - House 6 / Table (E, Perpendicular)



Position of surface in external scene:
 Marked point: (38.898 m, 55.448 m,
 0.000 m)



1.000 134

0.000 103

m 4.000

Attention: The coordinates refer to the image above. Values in Lux.

Grid: 1 x 2 Points

E_{av} [lx]	E_{min} [lx]	E_{max} [lx]	u0	E_{min} / E_{max}
118	103	134	0.87	0.77

MIDSTREAM LIGHTING LIMITED
 WESSEX HOUSE
 1 CHESHAM STREET
 LONDON, SW 1X 8ND, UNITED KINGDOM

Operator MIDSTREAM LIGHTING LIMITED
 Telephone +44 (0)207 584 8310
 Fax
 e-Mail info@midstreamlighting.com

ALL ON / Spill Out - House 7 / Table (E, Perpendicular)



Position of surface in external scene:
 Marked point: (38.898 m, 44.103 m,
 0.000 m)



1.000 105

0.000 90

m 4.000

Attention: The coordinates refer to the image above. Values in Lux.

Grid: 1 x 2 Points

E_{av} [lx]	E_{min} [lx]	E_{max} [lx]	u0	E_{min} / E_{max}
97	90	105	0.92	0.86

MIDSTREAM LIGHTING LIMITED
 WESSEX HOUSE
 1 CHESHAM STREET
 LONDON, SW 1X 8ND, UNITED KINGDOM

Operator MIDSTREAM LIGHTING LIMITED
 Telephone +44 (0)207 584 8310
 Fax
 e-Mail info@midstreamlighting.com

ALL ON / Spill Out - House 8 / Table (E, Perpendicular)



Position of surface in external scene:
 Marked point: (39.495 m, 31.565 m,
 0.000 m)



1.000 91

0.000 75

m 4.000

Attention: The coordinates refer to the image above. Values in Lux.

Grid: 1 x 2 Points

E_{av} [lx]	E_{min} [lx]	E_{max} [lx]	u0	E_{min} / E_{max}
83	75	91	0.90	0.82

MIDSTREAM LIGHTING LIMITED
 WESSEX HOUSE
 1 CHESHAM STREET
 LONDON, SW 1X 8ND, UNITED KINGDOM

Operator MIDSTREAM LIGHTING LIMITED
 Telephone +44 (0)207 584 8310
 Fax
 e-Mail info@midstreamlighting.com

ALL ON / Spill Out - House 9 / Table (E, Perpendicular)



Position of surface in external scene:
 Marked point: (41.592 m, 20.240 m,
 0.000 m)

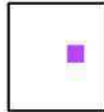

1.000 180

0.000 129

m 4.500

Attention: The coordinates refer to the image above. Values in Lux.

Grid: 1 x 2 Points

E_{av} [lx]	E_{min} [lx]	E_{max} [lx]	$u0$	E_{min} / E_{max}
154	129	180	0.83	0.72

MIDSTREAM LIGHTING LIMITED
 WESSEX HOUSE
 1 CHESHAM STREET
 LONDON, SW 1X 8ND, UNITED KINGDOM

Operator MIDSTREAM LIGHTING LIMITED
 Telephone +44 (0)207 584 8310
 Fax
 e-Mail info@midstreamlighting.com

ALL ON / Spill Out - House 10 / Table (E, Perpendicular)



Position of surface in external scene:
 Marked point: (43.316 m, 7.562 m,
 0.000 m)

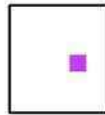

1.000 132

0.000 115

m 4.000

Attention: The coordinates refer to the image above. Values in Lux.

Grid: 1 x 2 Points

E_{av} [lx]
124

E_{min} [lx]
115

E_{max} [lx]
132

u_0
0.93

E_{min} / E_{max}
0.87

MIDSTREAM LIGHTING LIMITED
 WESSEX HOUSE
 1 CHESHAM STREET
 LONDON, SW 1X 8ND, UNITED KINGDOM

Operator MIDSTREAM LIGHTING LIMITED
 Telephone +44 (0)207 584 8310
 Fax
 e-Mail info@midstreamlighting.com

ALL ON / Spill Out - House 11 / Table (E, Perpendicular)



Position of surface in external scene:
 Marked point: (44.417 m, -3.158 m,
 0.000 m)



1.000 118

0.000 103

m 4.500

Attention: The coordinates refer to the image above. Values in Lux.

Grid: 1 x 2 Points

E_{av} [lx]	E_{min} [lx]	E_{max} [lx]	$u0$	E_{min} / E_{max}
111	103	118	0.93	0.87

MIDSTREAM LIGHTING LIMITED
 WESSEX HOUSE
 1 CHESHAM STREET
 LONDON, SW 1X 8ND, UNITED KINGDOM

Operator MIDSTREAM LIGHTING LIMITED
 Telephone +44 (0)207 584 8310
 Fax
 e-Mail info@midstreamlighting.com

ALL ON / Spill Out - House 12 / Table (E, Perpendicular)



Position of surface in external scene:
 Marked point: (46.352 m, -15.281 m,
 0.000 m)

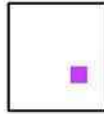

1.000 35

0.000 31

m 3.500

Attention: The coordinates refer to the image above. Values in Lux.

Grid: 1 x 2 Points

E_{av} [lx]
33

E_{min} [lx]
31

E_{max} [lx]
35

$u0$
0.93

E_{min} / E_{max}
0.86

MIDSTREAM LIGHTING LIMITED
 WESSEX HOUSE
 1 CHESHAM STREET
 LONDON, SW 1X 8ND, UNITED KINGDOM

Operator MIDSTREAM LIGHTING LIMITED
 Telephone +44 (0)207 584 8310
 Fax
 e-Mail info@midstreamlighting.com

ALL ON / Spill Out - House 13 / Table (E, Perpendicular)



Position of surface in external scene:
 Marked point: (47.070 m, -25.177 m,
 0.000 m)

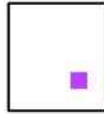

1.000 12

0.000 11

m 3.500

Attention: The coordinates refer to the image above. Values in Lux.

Grid: 1 x 2 Points

E_{av} [lx]	E_{min} [lx]	E_{max} [lx]	u0	E_{min} / E_{max}
12	11	12	0.95	0.90

MIDSTREAM LIGHTING LIMITED
 WESSEX HOUSE
 1 CHESHAM STREET
 LONDON, SW 1X 8ND, UNITED KINGDOM

Operator MIDSTREAM LIGHTING LIMITED
 Telephone +44 (0)207 584 8310
 Fax
 e-Mail info@midstreamlighting.com

ALL ON / Spill Out - House 14 / Table (E, Perpendicular)



Position of surface in external scene:
 Marked point: (48.212 m, -35.069 m,
 0.000 m)

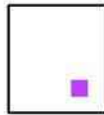

1.000 5.99

0.000 5.80

m **4.000**

Attention: The coordinates refer to the image above. Values in Lux.

Grid: 1 x 2 Points

E_{av} [lx]
5.90

E_{min} [lx]
5.80

E_{max} [lx]
5.99

u_0
0.98

E_{min} / E_{max}
0.97

MIDSTREAM LIGHTING LIMITED
 WESSEX HOUSE
 1 CHESHAM STREET
 LONDON, SW 1X 8ND, UNITED KINGDOM

Operator MIDSTREAM LIGHTING LIMITED
 Telephone +44 (0)207 584 8310
 Fax
 e-Mail info@midstreamlighting.com

ALL ON / Spill Out - House 15 / Table (E, Perpendicular)



Position of surface in external scene:
 Marked point: (49.630 m, -45.019 m,
 0.000 m)

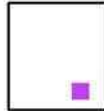

1.000 3.79
0.000 3.84
m **3.000**

Attention: The coordinates refer to the image above. Values in Lux.

Grid: 1 x 2 Points

E_{av} [lx]	E_{min} [lx]	E_{max} [lx]	$u0$	E_{min} / E_{max}
3.82	3.79	3.84	0.99	0.99

MIDSTREAM LIGHTING LIMITED
 WESSEX HOUSE
 1 CHESHAM STREET
 LONDON, SW 1X 8ND, UNITED KINGDOM

Operator MIDSTREAM LIGHTING LIMITED
 Telephone +44 (0)207 584 8310
 Fax
 e-Mail info@midstreamlighting.com

ALL ON / Spill Out - House 16 / Table (E, Perpendicular)



Position of surface in external scene:
 Marked point: (50.533 m, -59.881 m,
 0.000 m)

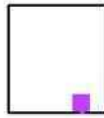

1.000 2.02

0.000 2.13

m 7.000

Attention: The coordinates refer to the image above. Values in Lux.

Grid: 1 x 2 Points

E_{av} [lx]
2.08

E_{min} [lx]
2.02

E_{max} [lx]
2.13

u_0
0.97

E_{min} / E_{max}
0.95

MIDSTREAM LIGHTING LIMITED
 WESSEX HOUSE
 1 CHESHAM STREET
 LONDON, SW 1X 8ND, UNITED KINGDOM

Operator MIDSTREAM LIGHTING LIMITED
 Telephone +44 (0)207 584 8310
 Fax
 e-Mail info@midstreamlighting.com

ALL ON / Spill Out - House 17 / Table (E, Perpendicular)



Position of surface in external scene:
 Marked point: (52.332 m, -85.105 m,
 0.000 m)

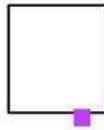

1.000 0.99

0.000 1.20

m 3.500

Attention: The coordinates refer to the image above. Values in Lux.

Grid: 1 x 2 Points

E_{av} [lx]
1.09

E_{min} [lx]
0.99

E_{max} [lx]
1.20

u0
0.91

E_{min} / E_{max}
0.83

MIDSTREAM LIGHTING LIMITED
 WESSEX HOUSE
 1 CHESHAM STREET
 LONDON, SW 1X 8ND, UNITED KINGDOM

Operator MIDSTREAM LIGHTING LIMITED
 Telephone +44 (0)207 584 8310
 Fax
 e-Mail info@midstreamlighting.com

ALL ON / Spill Out - House 18 / Table (E, Perpendicular)



Position of surface in external scene:
 Marked point: (41.800 m, -93.315 m,
 1.000 m)



1.000 3.72

0.000 3.08

m 3.500

Attention: The coordinates refer to the image above. Values in Lux.

Grid: 1 x 2 Points

E_{av} [lx]	E_{min} [lx]	E_{max} [lx]	u0	E_{min} / E_{max}
3.40	3.08	3.72	0.91	0.83

MIDSTREAM LIGHTING LIMITED
 WESSEX HOUSE
 1 CHESHAM STREET
 LONDON, SW 1X 8ND, UNITED KINGDOM

Operator MIDSTREAM LIGHTING LIMITED
 Telephone +44 (0)207 584 8310
 Fax
 e-Mail info@midstreamlighting.com

ALL ON / Spill Out - House 19 / Table (E, Perpendicular)



Position of surface in external scene:
 Marked point: (32.340 m, -91.908 m,
 1.000 m)

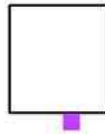

1.000 4.50

0.000 3.73

m **4.000**

Attention: The coordinates refer to the image above. Values in Lux.

Grid: 1 x 2 Points

E_{av} [lx]	E_{min} [lx]	E_{max} [lx]	u0	E_{min} / E_{max}
4.12	3.73	4.50	0.91	0.83

MIDSTREAM LIGHTING LIMITED
 WESSEX HOUSE
 1 CHESHAM STREET
 LONDON, SW 1X 8ND, UNITED KINGDOM

Operator MIDSTREAM LIGHTING LIMITED
 Telephone +44 (0)207 584 8310
 Fax
 e-Mail info@midstreamlighting.com

ALL ON / Spill Out - House 20 / Table (E, Perpendicular)



Position of surface in external scene:
 Marked point: (22.195 m, -90.405 m,
 1.000 m)



1.000 5.35

0.000 4.45

m **4.000**

Attention: The coordinates refer to the image above. Values in Lux.

Grid: 1 x 2 Points

E_{av} [lx]	E_{min} [lx]	E_{max} [lx]	u0	E_{min} / E_{max}
4.90	4.45	5.35	0.91	0.83

MIDSTREAM LIGHTING LIMITED
 WESSEX HOUSE
 1 CHESHAM STREET
 LONDON, SW 1X 8ND, UNITED KINGDOM

Operator MIDSTREAM LIGHTING LIMITED
 Telephone +44 (0)207 584 8310
 Fax
 e-Mail info@midstreamlighting.com

ALL ON / Spill Out - House 21 / Table (E, Perpendicular)



Position of surface in external scene:
 Marked point: (11.209 m, -88.495 m,
 1.000 m)

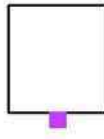

1.000 6.15

0.000 5.09

m **4.000**

Attention: The coordinates refer to the image above. Values in Lux.

Grid: 1 x 2 Points

E_{av} [lx]	E_{min} [lx]	E_{max} [lx]	u_0	E_{min} / E_{max}
5.62	5.09	6.15	0.91	0.83

MIDSTREAM LIGHTING LIMITED
 WESSEX HOUSE
 1 CHESHAM STREET
 LONDON, SW 1X 8ND, UNITED KINGDOM

Operator MIDSTREAM LIGHTING LIMITED
 Telephone +44 (0)207 584 8310
 Fax
 e-Mail info@midstreamlighting.com

ALL ON / Spill Out - House 22 / Table (E, Perpendicular)



Position of surface in external scene:
 Marked point: (-1.251 m, -86.736 m,
 1.000 m)

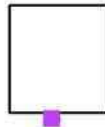

1.000 6.36

0.000 5.31

m **5.000**

Attention: The coordinates refer to the image above. Values in Lux.

Grid: 1 x 2 Points

E_{av} [lx]
5.84

E_{min} [lx]
5.31

E_{max} [lx]
6.36

$u0$
0.91

E_{min} / E_{max}
0.83

MIDSTREAM LIGHTING LIMITED
 WESSEX HOUSE
 1 CHESHAM STREET
 LONDON, SW 1X 8ND, UNITED KINGDOM

Operator MIDSTREAM LIGHTING LIMITED
 Telephone +44 (0)207 584 8310
 Fax
 e-Mail info@midstreamlighting.com

ALL ON / Spill Out - House 23 / Table (E, Perpendicular)



Position of surface in external scene:
 Marked point: (-11.460 m, -84.956 m,
 1.000 m)



1.000 6.14

0.000 5.12

m **3.500**

Attention: The coordinates refer to the image above. Values in Lux.

Grid: 1 x 2 Points

E_{av} [lx]
5.63

E_{min} [lx]
5.12

E_{max} [lx]
6.14

u_0
0.91

E_{min} / E_{max}
0.83

MIDSTREAM LIGHTING LIMITED
 WESSEX HOUSE
 1 CHESHAM STREET
 LONDON, SW 1X 8ND, UNITED KINGDOM

Operator MIDSTREAM LIGHTING LIMITED
 Telephone +44 (0)207 584 8310
 Fax
 e-Mail info@midstreamlighting.com

ALL ON / Spill Out - House 24 / Table (E, Perpendicular)



Position of surface in external scene:
 Marked point: (-20.416 m, -83.762 m,
 1.000 m)

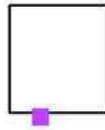

1.000 5.59

0.000 4.67

m **3.500**

Attention: The coordinates refer to the image above. Values in Lux.

Grid: 1 x 2 Points

E_{av} [lx]
5.13

E_{min} [lx]
4.67

E_{max} [lx]
5.59

u_0
0.91

E_{min} / E_{max}
0.83

MIDSTREAM LIGHTING LIMITED
 WESSEX HOUSE
 1 CHESHAM STREET
 LONDON, SW 1X 8ND, UNITED KINGDOM

Operator MIDSTREAM LIGHTING LIMITED
 Telephone +44 (0)207 584 8310
 Fax
 e-Mail info@midstreamlighting.com

ALL ON / Spill Out - House 25 / Table (E, Perpendicular)



Position of surface in external scene:
 Marked point: (-33.732 m, -81.720 m,
 1.000 m)



1.000 4.51

0.000 3.83

m **5.000**

Attention: The coordinates refer to the image above. Values in Lux.

Grid: 1 x 2 Points

E_{av} [lx]
4.17

E_{min} [lx]
3.83

E_{max} [lx]
4.51

u_0
0.92

E_{min} / E_{max}
0.85

MIDSTREAM LIGHTING LIMITED
 WESSEX HOUSE
 1 CHESHAM STREET
 LONDON, SW 1X 8ND, UNITED KINGDOM

Operator MIDSTREAM LIGHTING LIMITED
 Telephone +44 (0)207 584 8310
 Fax
 e-Mail info@midstreamlighting.com

ALL ON / Spill Out - House 26 / Table (E, Perpendicular)



Position of surface in external scene:
 Marked point: (-46.390 m, -79.929 m,
 1.000 m)

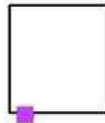

1.000 3.39

0.000 2.95

m **5.000**

Attention: The coordinates refer to the image above. Values in Lux.

Grid: 1 x 2 Points

E_{av} [lx]	E_{min} [lx]	E_{max} [lx]	$u0$	E_{min} / E_{max}
3.17	2.95	3.39	0.93	0.87

MIDSTREAM LIGHTING LIMITED
 WESSEX HOUSE
 1 CHESHAM STREET
 LONDON, SW 1X 8ND, UNITED KINGDOM

Operator MIDSTREAM LIGHTING LIMITED
 Telephone +44 (0)207 584 8310
 Fax
 e-Mail info@midstreamlighting.com

ALL ON / Spill Out - House 27 / Table (E, Perpendicular)



Position of surface in external scene:
 Marked point: (-60.720 m, -78.018 m,
 1.000 m)

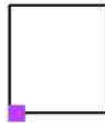

1.000 2.38

0.000 2.17

m **5.000**

Attention: The coordinates refer to the image above. Values in Lux.

Grid: 1 x 2 Points

E_{av} [lx]
2.27

E_{min} [lx]
2.17

E_{max} [lx]
2.38

u_0
0.95

E_{min} / E_{max}
0.91

MIDSTREAM LIGHTING LIMITED
 WESSEX HOUSE
 1 CHESHAM STREET
 LONDON, SW 1X 8ND, UNITED KINGDOM

Operator MIDSTREAM LIGHTING LIMITED
 Telephone +44 (0)207 584 8310
 Fax
 e-Mail info@midstreamlighting.com

ALL ON / Spill Out - House 28 / Table (E, Perpendicular)



Position of surface in external scene:
 Marked point: (-81.388 m, -74.939 m,
 1.000 m)

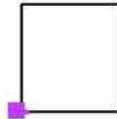

1.000 1.56
0.000 1.47
 m **8.500**

Attention: The coordinates refer to the image above. Values in Lux.

Grid: 1 x 2 Points

E_{av} [lx]	E_{min} [lx]	E_{max} [lx]	$u0$	E_{min} / E_{max}
1.51	1.47	1.56	0.97	0.94

MIDSTREAM LIGHTING LIMITED
 WESSEX HOUSE
 1 CHESHAM STREET
 LONDON, SW 1X 8ND, UNITED KINGDOM

Operator MIDSTREAM LIGHTING LIMITED
 Telephone +44 (0)207 584 8310
 Fax
 e-Mail info@midstreamlighting.com

ALL ON / Spill Out - House 29 / Table (E, Perpendicular)



Position of surface in external scene:
 Marked point: (-94.733 m, -72.808 m,
 1.000 m)



1.000 0.97

0.000 0.91

m 4.500

Attention: The coordinates refer to the image above. Values in Lux.

Grid: 1 x 2 Points

E_{av} [lx]
0.94

E_{min} [lx]
0.91

E_{max} [lx]
0.97

u_0
0.97

E_{min} / E_{max}
0.94

MIDSTREAM LIGHTING LIMITED
 WESSEX HOUSE
 1 CHESHAM STREET
 LONDON, SW 1X 8ND, UNITED KINGDOM

Operator MIDSTREAM LIGHTING LIMITED
 Telephone +44 (0)207 584 8310
 Fax
 e-Mail info@midstreamlighting.com

ALL ON / Spill Out - House 30 / Table (E, Perpendicular)



Position of surface in external scene:
 Marked point: (-103.573 m, -69.333 m,
 1.000 m)



1.000 0.90

0.000 0.85

m 3.500

Attention: The coordinates refer to the image above. Values in Lux.

Grid: 1 x 2 Points

E_{av} [lx]
0.87

E_{min} [lx]
0.85

E_{max} [lx]
0.90

u0
0.97

E_{min} / E_{max}
0.95

MIDSTREAM LIGHTING LIMITED
 WESSEX HOUSE
 1 CHESHAM STREET
 LONDON, SW 1X 8ND, UNITED KINGDOM

Operator MIDSTREAM LIGHTING LIMITED
 Telephone +44 (0)207 584 8310
 Fax
 e-Mail info@midstreamlighting.com

ALL ON / Spill Out - House 31 / Table (E, Perpendicular)



Position of surface in external scene:
 Marked point: (-110.486 m, -63.666 m,
 1.000 m)

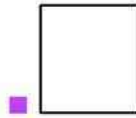

1.000 0.80

0.000 0.77

m 3.500

Attention: The coordinates refer to the image above. Values in Lux.

Grid: 1 x 2 Points

E_{av} [lx]
0.78

E_{min} [lx]
0.77

E_{max} [lx]
0.80

u0
0.98

E_{min} / E_{max}
0.96

MIDSTREAM LIGHTING LIMITED
 WESSEX HOUSE
 1 CHESHAM STREET
 LONDON, SW 1X 8ND, UNITED KINGDOM

Operator MIDSTREAM LIGHTING LIMITED
 Telephone +44 (0)207 584 8310
 Fax
 e-Mail info@midstreamlighting.com

ALL ON / Spill Out - House 32 / Table (E, Perpendicular)



Position of surface in external scene:
 Marked point: (-116.576 m, -58.292 m,
 1.000 m)



1.000 0.69

0.000 0.67

m 3.500

Attention: The coordinates refer to the image above. Values in Lux.

Grid: 1 x 2 Points

E_{av} [lx]	E_{min} [lx]	E_{max} [lx]	u0	E_{min} / E_{max}
0.68	0.67	0.69	0.98	0.97

MIDSTREAM LIGHTING LIMITED
 WESSEX HOUSE
 1 CHESHAM STREET
 LONDON, SW 1X 8ND, UNITED KINGDOM

Operator MIDSTREAM LIGHTING LIMITED
 Telephone +44 (0)207 584 8310
 Fax
 e-Mail info@midstreamlighting.com

ALL ON / Spill Out - House 33 / Table (E, Perpendicular)



Position of surface in external scene:
 Marked point: (-118.474 m, -43.022 m,
 1.000 m)

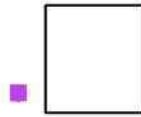

1.000 0.49

0.000 0.49

m **5.000**

Attention: The coordinates refer to the image above. Values in Lux.

Grid: 1 x 2 Points

E_{av} [lx]	E_{min} [lx]	E_{max} [lx]	$u0$	E_{min} / E_{max}
0.49	0.49	0.49	1.00	0.99

MIDSTREAM LIGHTING LIMITED
 WESSEX HOUSE
 1 CHESHAM STREET
 LONDON, SW 1X 8ND, UNITED KINGDOM

Operator MIDSTREAM LIGHTING LIMITED
 Telephone +44 (0)207 584 8310
 Fax
 e-Mail info@midstreamlighting.com

ALL ON / Spill Out - House 34 / Table (E, Perpendicular)



Position of surface in external scene:
 Marked point: (-119.430 m, -23.558 m,
 1.000 m)



1.000 0.55

0.000 0.54

m 5.000

Attention: The coordinates refer to the image above. Values in Lux.

Grid: 1 x 2 Points

E_{av} [lx]
0.55

E_{min} [lx]
0.54

E_{max} [lx]
0.55

$u0$
1.00

E_{min} / E_{max}
1.00

MIDSTREAM LIGHTING LIMITED
 WESSEX HOUSE
 1 CHESHAM STREET
 LONDON, SW 1X 8ND, UNITED KINGDOM

Operator MIDSTREAM LIGHTING LIMITED
 Telephone +44 (0)207 584 8310
 Fax
 e-Mail info@midstreamlighting.com

ALL ON / Spill Out - House 35 / Table (E, Perpendicular)



Position of surface in external scene:
 Marked point: (-124.229 m, 2.372 m,
 1.000 m)

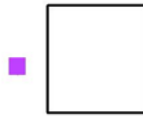

1.000 0.52

0.000 0.54

m 5.000

Attention: The coordinates refer to the image above. Values in Lux.

Grid: 1 x 2 Points

E_{av} [lx]
0.53

E_{min} [lx]
0.52

E_{max} [lx]
0.54

$u0$
0.99

E_{min} / E_{max}
0.97

MIDSTREAM LIGHTING LIMITED
 WESSEX HOUSE
 1 CHESHAM STREET
 LONDON, SW 1X 8ND, UNITED KINGDOM

Operator MIDSTREAM LIGHTING LIMITED
 Telephone +44 (0)207 584 8310
 Fax
 e-Mail info@midstreamlighting.com

ALL ON / Spill Out - House 36 / Table (E, Perpendicular)



Position of surface in external scene:
 Marked point: (-130.952 m, 24.058 m,
 1.000 m)

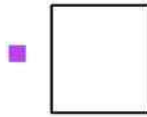

1.000 0.42

0.000 0.44

m **5.000**

Attention: The coordinates refer to the image above. Values in Lux.

Grid: 1 x 2 Points

E_{av} [lx]
0.43

E_{min} [lx]
0.42

E_{max} [lx]
0.44

$u0$
0.98

E_{min} / E_{max}
0.96

MIDSTREAM LIGHTING LIMITED
 WESSEX HOUSE
 1 CHESHAM STREET
 LONDON, SW 1X 8ND, UNITED KINGDOM

Operator MIDSTREAM LIGHTING LIMITED
 Telephone +44 (0)207 584 8310
 Fax
 e-Mail info@midstreamlighting.com

ALL ON / Spill Out - House 37 / Table (E, Perpendicular)



Position of surface in external scene:
 Marked point: (-138.256 m, 47.354 m,
 1.000 m)

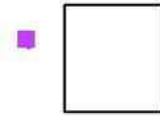

1.000 0.31

0.000 0.34

m 6.000

Attention: The coordinates refer to the image above. Values in Lux.

Grid: 1 x 2 Points

E_{av} [lx]
0.32

E_{min} [lx]
0.31

E_{max} [lx]
0.34

u0
0.97

E_{min} / E_{max}
0.94

MIDSTREAM LIGHTING LIMITED
 WESSEX HOUSE
 1 CHESHAM STREET
 LONDON, SW 1X 8ND, UNITED KINGDOM

Operator MIDSTREAM LIGHTING LIMITED
 Telephone +44 (0)207 584 8310
 Fax
 e-Mail info@midstreamlighting.com

ALL ON / Spill Out - House 38 / Table (E, Perpendicular)



Position of surface in external scene:
 Marked point: (-146.347 m, 67.639 m,
 1.000 m)



1.000 0.23

0.000 0.25

m 4.500

Attention: The coordinates refer to the image above. Values in Lux.

Grid: 1 x 2 Points

E_{av} [lx]	E_{min} [lx]	E_{max} [lx]	u0	E_{min} / E_{max}
0.24	0.23	0.25	0.96	0.92

MIDSTREAM LIGHTING LIMITED
 WESSEX HOUSE
 1 CHESHAM STREET
 LONDON, SW 1X 8ND, UNITED KINGDOM

Operator MIDSTREAM LIGHTING LIMITED
 Telephone +44 (0)207 584 8310
 Fax
 e-Mail info@midstreamlighting.com

ALL ON / Spill Out - House 39 / Table (E, Perpendicular)



Position of surface in external scene:
 Marked point: (-153.651 m, 80.547 m,
 1.000 m)

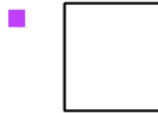

1.000 0.19

0.000 0.20

m 5.500

Attention: The coordinates refer to the image above. Values in Lux.

Grid: 1 x 2 Points

E_{av} [lx]	E_{min} [lx]	E_{max} [lx]	$u0$	E_{min} / E_{max}
0.20	0.19	0.20	0.96	0.92

MIDSTREAM LIGHTING LIMITED
 WESSEX HOUSE
 1 CHESHAM STREET
 LONDON, SW 1X 8ND, UNITED KINGDOM

Operator MIDSTREAM LIGHTING LIMITED
 Telephone +44 (0)207 584 8310
 Fax
 e-Mail info@midstreamlighting.com

ALL ON / Spill Out - House 40 / Table (E, Perpendicular)



Position of surface in external scene:
 Marked point: (-161.880 m, 95.588 m,
 1.000 m)

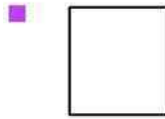

1.000 0.15

0.000 0.16

m 5.000

Attention: The coordinates refer to the image above. Values in Lux.

Grid: 1 x 2 Points

E_{av} [lx]	E_{min} [lx]	E_{max} [lx]	$u0$	E_{min} / E_{max}
0.15	0.15	0.16	0.96	0.92

MIDSTREAM LIGHTING LIMITED
 WESSEX HOUSE
 1 CHESHAM STREET
 LONDON, SW 1X 8ND, UNITED KINGDOM

Operator MIDSTREAM LIGHTING LIMITED
 Telephone +44 (0)207 584 8310
 Fax
 e-Mail info@midstreamlighting.com

ALL ON / Spill Out - House 41 / Table (E, Perpendicular)



Position of surface in external scene:
 Marked point: (-166.409 m,
 109.315 m, 1.000 m)



1.000 0.12

0.000 0.13

m 4.500

Attention: The coordinates refer to the image above. Values in Lux.

Grid: 1 x 2 Points

E_{av} [lx]	E_{min} [lx]	E_{max} [lx]	u0	E_{min} / E_{max}
0.12	0.12	0.13	0.96	0.92

MIDSTREAM LIGHTING LIMITED
 WESSEX HOUSE
 1 CHESHAM STREET
 LONDON, SW 1X 8ND, UNITED KINGDOM

Operator MIDSTREAM LIGHTING LIMITED
 Telephone +44 (0)207 584 8310
 Fax
 e-Mail info@midstreamlighting.com

ALL ON / Spill Out - House 42 / Table (E, Perpendicular)



Position of surface in external scene:
 Marked point: (-170.956 m,
 121.501 m, 1.000 m)



1.000 0.10

0.000 0.11

m 5.000

Attention: The coordinates refer to the image above. Values in Lux.

Grid: 1 x 2 Points

E_{av} [lx]	E_{min} [lx]	E_{max} [lx]	$u0$	E_{min} / E_{max}
0.10	0.10	0.11	0.96	0.92

MIDSTREAM LIGHTING LIMITED
 WESSEX HOUSE
 1 CHESHAM STREET
 LONDON, SW 1X 8ND, UNITED KINGDOM

Operator MIDSTREAM LIGHTING LIMITED
 Telephone +44 (0)207 584 8310
 Fax
 e-Mail info@midstreamlighting.com

ALL ON / Spill Out - House 43 / Table (E, Perpendicular)



Position of surface in external scene:
 Marked point: (-172.747 m,
 133.801 m, 1.000 m)



1.000 0.09

0.000 0.10

m 5.000

Attention: The coordinates refer to the image above. Values in Lux.

Grid: 1 x 2 Points

E_{av} [lx]	E_{min} [lx]	E_{max} [lx]	$u0$	E_{min} / E_{max}
0.10	0.09	0.10	0.96	0.92

MIDSTREAM LIGHTING LIMITED
 WESSEX HOUSE
 1 CHESHAM STREET
 LONDON, SW 1X 8ND, UNITED KINGDOM

Operator MIDSTREAM LIGHTING LIMITED
 Telephone +44 (0)207 584 8310
 Fax
 e-Mail info@midstreamlighting.com

GR Calculation / GR Observer (Results Overview)

GR Observerlist

No.	Designation	Position [m]			Viewing sector [°]				Max
		X	Y	Z	Start	End	Increment	Slope angle	
5	GR Observer 5	6.204	-6.360	1.500	0.0	360.0	15.0	-2.0	46 ²⁾
6	GR Observer 6	6.204	-4.240	1.500	0.0	360.0	15.0	-2.0	46 ²⁾
7	GR Observer 7	6.204	-2.120	1.500	0.0	360.0	15.0	-2.0	46 ²⁾
8	GR Observer 8	6.204	0.000	1.500	0.0	360.0	15.0	-2.0	46 ²⁾
9	GR Observer 9	6.204	2.120	1.500	0.0	360.0	15.0	-2.0	48 ²⁾
10	GR Observer 10	6.204	4.240	1.500	0.0	360.0	15.0	-2.0	48 ²⁾
11	GR Observer 11	6.204	6.360	1.500	0.0	360.0	15.0	-2.0	47 ²⁾
12	GR Observer 12	6.204	8.480	1.500	0.0	360.0	15.0	-2.0	46 ²⁾
13	GR Observer 13	6.204	10.600	1.500	0.0	360.0	15.0	-2.0	45 ²⁾
14	GR Observer 14	6.204	12.720	1.500	0.0	360.0	15.0	-2.0	42 ²⁾
15	GR Observer 15	6.204	14.840	1.500	0.0	360.0	15.0	-2.0	36 ²⁾
16	GR Observer 16	4.129	-14.751	1.500	0.0	360.0	15.0	-2.0	38 ²⁾
17	GR Observer 17	4.133	-12.720	1.500	0.0	360.0	15.0	-2.0	39 ²⁾
18	GR Observer 18	4.133	-10.600	1.500	0.0	360.0	15.0	-2.0	42 ²⁾
19	GR Observer 19	4.133	-8.480	1.500	0.0	360.0	15.0	-2.0	45 ²⁾
20	GR Observer 20	4.133	-6.360	1.500	0.0	360.0	15.0	-2.0	47 ²⁾
21	GR Observer 21	4.133	-4.240	1.500	0.0	360.0	15.0	-2.0	48 ²⁾
22	GR Observer 22	4.133	-2.120	1.500	0.0	360.0	15.0	-2.0	47 ²⁾
23	GR Observer 23	4.133	0.000	1.500	0.0	360.0	15.0	-2.0	47 ²⁾
24	GR Observer 24	4.133	2.120	1.500	0.0	360.0	15.0	-2.0	49 ²⁾
25	GR Observer 25	4.133	4.240	1.500	0.0	360.0	15.0	-2.0	49 ²⁾
26	GR Observer 26	4.133	6.360	1.500	0.0	360.0	15.0	-2.0	49 ²⁾
27	GR Observer 27	4.133	8.480	1.500	0.0	360.0	15.0	-2.0	47 ²⁾
28	GR Observer 28	4.133	10.600	1.500	0.0	360.0	15.0	-2.0	44 ²⁾
29	GR Observer 29	4.133	12.720	1.500	0.0	360.0	15.0	-2.0	41 ²⁾
30	GR Observer 30	4.133	14.840	1.500	0.0	360.0	15.0	-2.0	35 ²⁾
31	GR Observer 31	2.057	-14.751	1.500	0.0	360.0	15.0	-2.0	38 ²⁾
32	GR Observer 32	2.061	-12.720	1.500	0.0	360.0	15.0	-2.0	39 ²⁾
33	GR Observer 33	2.061	-10.600	1.500	0.0	360.0	15.0	-2.0	40 ²⁾
34	GR Observer 34	2.061	-8.480	1.500	0.0	360.0	15.0	-2.0	42 ²⁾
35	GR Observer 35	2.061	-6.360	1.500	0.0	360.0	15.0	-2.0	45 ²⁾
36	GR Observer 36	2.061	-4.240	1.500	0.0	360.0	15.0	-2.0	47 ²⁾
37	GR Observer 37	2.061	-2.120	1.500	0.0	360.0	15.0	-2.0	47 ²⁾
38	GR Observer 38	2.061	0.000	1.500	0.0	360.0	15.0	-2.0	47 ²⁾
39	GR Observer 39	2.061	2.120	1.500	0.0	360.0	15.0	-2.0	48 ²⁾
40	GR Observer 40	2.061	4.240	1.500	0.0	360.0	15.0	-2.0	49 ²⁾

MIDSTREAM LIGHTING LIMITED
 WESSEX HOUSE
 1 CHESHAM STREET
 LONDON, SW 1X 8ND, UNITED KINGDOM

Operator MIDSTREAM LIGHTING LIMITED
 Telephone +44 (0)207 584 8310
 Fax
 e-Mail info@midstreamlighting.com

GR Calculation / GR Observer (Results Overview)

GR Observerlist

No.	Designation	Position [m]			Viewing sector [°]				Max
		X	Y	Z	Start	End	Increment	Slope angle	
41	GR Observer 41	2.061	6.360	1.500	0.0	360.0	15.0	-2.0	47 ²⁾
42	GR Observer 42	2.061	8.480	1.500	0.0	360.0	15.0	-2.0	44 ²⁾
43	GR Observer 43	2.061	10.600	1.500	0.0	360.0	15.0	-2.0	41 ²⁾
44	GR Observer 44	2.061	12.720	1.500	0.0	360.0	15.0	-2.0	37 ²⁾
45	GR Observer 45	2.061	14.840	1.500	0.0	360.0	15.0	-2.0	35 ²⁾
46	GR Observer 46	-0.014	-14.751	1.500	0.0	360.0	15.0	-2.0	39 ²⁾
47	GR Observer 47	-0.010	-12.720	1.500	0.0	360.0	15.0	-2.0	40 ²⁾
48	GR Observer 48	-0.010	-10.600	1.500	0.0	360.0	15.0	-2.0	41 ²⁾
49	GR Observer 49	-0.010	-8.480	1.500	0.0	360.0	15.0	-2.0	42 ²⁾
50	GR Observer 50	-0.010	-6.360	1.500	0.0	360.0	15.0	-2.0	43 ²⁾
51	GR Observer 51	-0.010	-4.240	1.500	0.0	360.0	15.0	-2.0	44 ²⁾
52	GR Observer 52	-0.010	-2.120	1.500	0.0	360.0	15.0	-2.0	45 ²⁾
53	GR Observer 53	-0.010	0.000	1.500	0.0	360.0	15.0	-2.0	46 ²⁾
54	GR Observer 54	-0.010	2.120	1.500	0.0	360.0	15.0	-2.0	46 ²⁾
55	GR Observer 55	-0.010	4.240	1.500	0.0	360.0	15.0	-2.0	45 ²⁾
56	GR Observer 56	-0.010	6.360	1.500	0.0	360.0	15.0	-2.0	43 ²⁾
57	GR Observer 57	-0.010	8.480	1.500	0.0	360.0	15.0	-2.0	40 ²⁾
58	GR Observer 58	-0.010	10.600	1.500	0.0	360.0	15.0	-2.0	39 ²⁾
59	GR Observer 59	-0.010	12.720	1.500	0.0	360.0	15.0	-2.0	37 ²⁾
60	GR Observer 60	-0.010	14.840	1.500	0.0	360.0	15.0	-2.0	36 ²⁾
61	GR Observer 61	-2.085	-14.751	1.500	0.0	360.0	15.0	-2.0	38 ²⁾
62	GR Observer 62	-2.081	-12.720	1.500	0.0	360.0	15.0	-2.0	39 ²⁾
63	GR Observer 63	-2.081	-10.600	1.500	0.0	360.0	15.0	-2.0	40 ²⁾
64	GR Observer 64	-2.081	-8.480	1.500	0.0	360.0	15.0	-2.0	41 ²⁾
65	GR Observer 65	-2.081	-6.360	1.500	0.0	360.0	15.0	-2.0	43 ²⁾
66	GR Observer 66	-2.081	-4.240	1.500	0.0	360.0	15.0	-2.0	44 ²⁾
67	GR Observer 67	-2.081	-2.120	1.500	0.0	360.0	15.0	-2.0	44 ²⁾
68	GR Observer 68	-2.081	0.000	1.500	0.0	360.0	15.0	-2.0	44 ²⁾
69	GR Observer 69	-2.081	2.120	1.500	0.0	360.0	15.0	-2.0	45 ²⁾
70	GR Observer 70	-2.081	4.240	1.500	0.0	360.0	15.0	-2.0	45 ²⁾
71	GR Observer 71	-2.081	6.360	1.500	0.0	360.0	15.0	-2.0	43 ²⁾
72	GR Observer 72	-2.081	8.480	1.500	0.0	360.0	15.0	-2.0	39 ²⁾
73	GR Observer 73	-2.081	10.600	1.500	0.0	360.0	15.0	-2.0	38 ²⁾
74	GR Observer 74	-2.081	12.720	1.500	0.0	360.0	15.0	-2.0	37 ²⁾
75	GR Observer 75	-2.081	14.840	1.500	0.0	360.0	15.0	-2.0	36 ²⁾
76	GR Observer 76	-4.157	-14.751	1.500	0.0	360.0	15.0	-2.0	37 ²⁾

MIDSTREAM LIGHTING LIMITED
 WESSEX HOUSE
 1 CHESHAM STREET
 LONDON, SW 1X 8ND, UNITED KINGDOM

Operator MIDSTREAM LIGHTING LIMITED
 Telephone +44 (0)207 584 8310
 Fax
 e-Mail info@midstreamlighting.com

GR Calculation / GR Observer (Results Overview)

GR Observerlist

No.	Designation	Position [m]			Viewing sector [°]				Max
		X	Y	Z	Start	End	Increment	Slope angle	
77	GR Observer 77	-4.153	-12.720	1.500	0.0	360.0	15.0	-2.0	38 ²⁾
78	GR Observer 78	-4.153	-10.600	1.500	0.0	360.0	15.0	-2.0	38 ²⁾
79	GR Observer 79	-4.153	-8.480	1.500	0.0	360.0	15.0	-2.0	42 ²⁾
80	GR Observer 80	-4.153	-6.360	1.500	0.0	360.0	15.0	-2.0	44 ²⁾
81	GR Observer 81	-4.153	-4.240	1.500	0.0	360.0	15.0	-2.0	45 ²⁾
82	GR Observer 82	-4.153	-2.120	1.500	0.0	360.0	15.0	-2.0	45 ²⁾
83	GR Observer 83	-4.153	0.000	1.500	0.0	360.0	15.0	-2.0	44 ²⁾
84	GR Observer 84	-4.153	2.120	1.500	0.0	360.0	15.0	-2.0	45 ²⁾
85	GR Observer 85	-4.153	4.240	1.500	0.0	360.0	15.0	-2.0	46 ²⁾
86	GR Observer 86	-4.153	6.360	1.500	0.0	360.0	15.0	-2.0	45 ²⁾
87	GR Observer 87	-4.153	8.480	1.500	0.0	360.0	15.0	-2.0	42 ²⁾
88	GR Observer 88	-4.153	10.600	1.500	0.0	360.0	15.0	-2.0	38 ²⁾
89	GR Observer 89	-4.153	12.720	1.500	0.0	360.0	15.0	-2.0	35 ²⁾
90	GR Observer 90	-4.153	14.840	1.500	0.0	360.0	15.0	-2.0	34 ²⁾
91	GR Observer 91	-6.228	-14.751	1.500	0.0	360.0	15.0	-2.0	35 ²⁾
92	GR Observer 92	-6.224	-12.720	1.500	0.0	360.0	15.0	-2.0	36 ²⁾
93	GR Observer 93	-6.224	-10.600	1.500	0.0	360.0	15.0	-2.0	38 ²⁾
94	GR Observer 94	-6.224	-8.480	1.500	0.0	360.0	15.0	-2.0	41 ²⁾
95	GR Observer 95	-6.224	-6.360	1.500	0.0	360.0	15.0	-2.0	42 ²⁾
96	GR Observer 96	-6.224	-4.240	1.500	0.0	360.0	15.0	-2.0	42 ²⁾
97	GR Observer 97	-6.224	4.240	1.500	0.0	360.0	15.0	-2.0	44 ²⁾
98	GR Observer 98	-6.224	6.360	1.500	0.0	360.0	15.0	-2.0	43 ²⁾
99	GR Observer 99	-6.224	8.480	1.500	0.0	360.0	15.0	-2.0	42 ²⁾
100	GR Observer 100	-6.224	10.600	1.500	0.0	360.0	15.0	-2.0	40 ²⁾
101	GR Observer 101	-6.224	12.720	1.500	0.0	360.0	15.0	-2.0	36 ²⁾
102	GR Observer 102	-6.224	14.840	1.500	0.0	360.0	15.0	-2.0	32 ²⁾
103	GR Observer 103	20.784	-14.840	1.500	0.0	360.0	15.0	-2.0	38 ²⁾
104	GR Observer 104	20.784	-12.720	1.500	0.0	360.0	15.0	-2.0	39 ²⁾
105	GR Observer 105	20.784	-10.600	1.500	0.0	360.0	15.0	-2.0	42 ²⁾
106	GR Observer 106	20.784	-8.480	1.500	0.0	360.0	15.0	-2.0	45 ²⁾
107	GR Observer 107	20.784	-6.360	1.500	0.0	360.0	15.0	-2.0	46 ²⁾
108	GR Observer 108	20.784	-4.240	1.500	0.0	360.0	15.0	-2.0	47 ²⁾
109	GR Observer 109	20.784	-2.120	1.500	0.0	360.0	15.0	-2.0	46 ²⁾
110	GR Observer 110	20.784	0.000	1.500	0.0	360.0	15.0	-2.0	46 ²⁾
111	GR Observer 111	20.784	2.120	1.500	0.0	360.0	15.0	-2.0	48 ²⁾
112	GR Observer 112	20.784	4.240	1.500	0.0	360.0	15.0	-2.0	48 ²⁾

MIDSTREAM LIGHTING LIMITED
 WESSEX HOUSE
 1 CHESHAM STREET
 LONDON, SW 1X 8ND, UNITED KINGDOM

Operator MIDSTREAM LIGHTING LIMITED
 Telephone +44 (0)207 584 8310
 Fax
 e-Mail info@midstreamlighting.com

GR Calculation / GR Observer (Results Overview)

GR Observerlist

No.	Designation	Position [m]			Viewing sector [°]				Max
		X	Y	Z	Start	End	Increment	Slope angle	
113	GR Observer 113	20.784	6.360	1.500	0.0	360.0	15.0	-2.0	48 ²⁾
114	GR Observer 114	20.784	8.480	1.500	0.0	360.0	15.0	-2.0	47 ²⁾
115	GR Observer 115	20.784	10.600	1.500	0.0	360.0	15.0	-2.0	45 ²⁾
116	GR Observer 116	20.784	12.720	1.500	0.0	360.0	15.0	-2.0	41 ²⁾
117	GR Observer 117	20.784	14.840	1.500	0.0	360.0	15.0	-2.0	36 ²⁾
118	GR Observer 118	18.713	-14.840	1.500	0.0	360.0	15.0	-2.0	38 ²⁾
119	GR Observer 119	18.713	-12.720	1.500	0.0	360.0	15.0	-2.0	39 ²⁾
120	GR Observer 120	18.713	-10.600	1.500	0.0	360.0	15.0	-2.0	41 ²⁾
121	GR Observer 121	18.713	-8.480	1.500	0.0	360.0	15.0	-2.0	45 ²⁾
122	GR Observer 122	18.713	-6.360	1.500	0.0	360.0	15.0	-2.0	47 ²⁾
123	GR Observer 123	18.713	-4.240	1.500	0.0	360.0	15.0	-2.0	48 ²⁾
124	GR Observer 124	18.713	-2.120	1.500	0.0	360.0	15.0	-2.0	47 ²⁾
125	GR Observer 125	18.713	0.000	1.500	0.0	360.0	15.0	-2.0	47 ²⁾
126	GR Observer 126	18.713	2.120	1.500	0.0	360.0	15.0	-2.0	48 ²⁾
127	GR Observer 127	18.713	4.240	1.500	0.0	360.0	15.0	-2.0	49 ²⁾
128	GR Observer 128	18.713	6.360	1.500	0.0	360.0	15.0	-2.0	48 ²⁾
129	GR Observer 129	18.713	8.480	1.500	0.0	360.0	15.0	-2.0	46 ²⁾
130	GR Observer 130	18.713	10.600	1.500	0.0	360.0	15.0	-2.0	43 ²⁾
131	GR Observer 131	18.713	12.720	1.500	0.0	360.0	15.0	-2.0	39 ²⁾
132	GR Observer 132	18.713	14.840	1.500	0.0	360.0	15.0	-2.0	36 ²⁾
133	GR Observer 133	16.641	-14.840	1.500	0.0	360.0	15.0	-2.0	38 ²⁾
134	GR Observer 134	16.641	-12.720	1.500	0.0	360.0	15.0	-2.0	39 ²⁾
135	GR Observer 135	16.641	-10.600	1.500	0.0	360.0	15.0	-2.0	40 ²⁾
136	GR Observer 136	16.641	-8.480	1.500	0.0	360.0	15.0	-2.0	42 ²⁾
137	GR Observer 137	16.641	-6.360	1.500	0.0	360.0	15.0	-2.0	45 ²⁾
138	GR Observer 138	16.641	-4.240	1.500	0.0	360.0	15.0	-2.0	47 ²⁾
139	GR Observer 139	16.641	-2.120	1.500	0.0	360.0	15.0	-2.0	47 ²⁾
140	GR Observer 140	16.641	0.000	1.500	0.0	360.0	15.0	-2.0	47 ²⁾
141	GR Observer 141	16.641	2.120	1.500	0.0	360.0	15.0	-2.0	48 ²⁾
142	GR Observer 142	16.641	4.240	1.500	0.0	360.0	15.0	-2.0	48 ²⁾
143	GR Observer 143	16.641	6.360	1.500	0.0	360.0	15.0	-2.0	46 ²⁾
144	GR Observer 144	16.641	8.480	1.500	0.0	360.0	15.0	-2.0	42 ²⁾
145	GR Observer 145	16.641	10.600	1.500	0.0	360.0	15.0	-2.0	39 ²⁾
146	GR Observer 146	16.641	12.720	1.500	0.0	360.0	15.0	-2.0	37 ²⁾
147	GR Observer 147	16.641	14.840	1.500	0.0	360.0	15.0	-2.0	36 ²⁾
148	GR Observer 148	14.570	-14.840	1.500	0.0	360.0	15.0	-2.0	38 ²⁾

MIDSTREAM LIGHTING LIMITED
 WESSEX HOUSE
 1 CHESHAM STREET
 LONDON, SW 1X 8ND, UNITED KINGDOM

Operator MIDSTREAM LIGHTING LIMITED
 Telephone +44 (0)207 584 8310
 Fax
 e-Mail info@midstreamlighting.com

GR Calculation / GR Observer (Results Overview)

GR Observerlist

No.	Designation	Position [m]			Viewing sector [°]				Max
		X	Y	Z	Start	End	Increment	Slope angle	
149	GR Observer 149	14.570	-12.720	1.500	0.0	360.0	15.0	-2.0	39 ²⁾
150	GR Observer 150	14.570	-10.600	1.500	0.0	360.0	15.0	-2.0	40 ²⁾
151	GR Observer 151	14.570	-8.480	1.500	0.0	360.0	15.0	-2.0	42 ²⁾
152	GR Observer 152	14.570	-6.360	1.500	0.0	360.0	15.0	-2.0	43 ²⁾
153	GR Observer 153	14.570	-4.240	1.500	0.0	360.0	15.0	-2.0	44 ²⁾
154	GR Observer 154	14.570	-2.120	1.500	0.0	360.0	15.0	-2.0	45 ²⁾
155	GR Observer 155	14.570	0.000	1.500	0.0	360.0	15.0	-2.0	46 ²⁾
156	GR Observer 156	14.570	2.120	1.500	0.0	360.0	15.0	-2.0	45 ²⁾
157	GR Observer 157	14.570	4.240	1.500	0.0	360.0	15.0	-2.0	44 ²⁾
158	GR Observer 158	14.570	6.360	1.500	0.0	360.0	15.0	-2.0	42 ²⁾
159	GR Observer 159	14.570	8.480	1.500	0.0	360.0	15.0	-2.0	40 ²⁾
160	GR Observer 160	14.570	10.600	1.500	0.0	360.0	15.0	-2.0	39 ²⁾
161	GR Observer 161	14.570	12.720	1.500	0.0	360.0	15.0	-2.0	38 ²⁾
162	GR Observer 162	14.570	14.840	1.500	0.0	360.0	15.0	-2.0	36 ²⁾
163	GR Observer 163	12.499	-14.840	1.500	0.0	360.0	15.0	-2.0	38 ²⁾
164	GR Observer 164	12.499	-12.720	1.500	0.0	360.0	15.0	-2.0	39 ²⁾
165	GR Observer 165	12.499	-10.600	1.500	0.0	360.0	15.0	-2.0	40 ²⁾
166	GR Observer 166	12.499	-8.480	1.500	0.0	360.0	15.0	-2.0	42 ²⁾
167	GR Observer 167	12.499	-6.360	1.500	0.0	360.0	15.0	-2.0	45 ²⁾
168	GR Observer 168	12.499	-4.240	1.500	0.0	360.0	15.0	-2.0	47 ²⁾
169	GR Observer 169	12.499	-2.120	1.500	0.0	360.0	15.0	-2.0	47 ²⁾
170	GR Observer 170	12.499	0.000	1.500	0.0	360.0	15.0	-2.0	47 ²⁾
171	GR Observer 171	12.499	2.120	1.500	0.0	360.0	15.0	-2.0	48 ²⁾
172	GR Observer 172	12.499	4.240	1.500	0.0	360.0	15.0	-2.0	48 ²⁾
173	GR Observer 173	12.499	6.360	1.500	0.0	360.0	15.0	-2.0	46 ²⁾
174	GR Observer 174	12.499	8.480	1.500	0.0	360.0	15.0	-2.0	42 ²⁾
175	GR Observer 175	12.499	10.600	1.500	0.0	360.0	15.0	-2.0	39 ²⁾
176	GR Observer 176	12.499	12.720	1.500	0.0	360.0	15.0	-2.0	37 ²⁾
177	GR Observer 177	12.499	14.840	1.500	0.0	360.0	15.0	-2.0	36 ²⁾
178	GR Observer 178	10.427	-14.840	1.500	0.0	360.0	15.0	-2.0	38 ²⁾
179	GR Observer 179	10.427	-12.720	1.500	0.0	360.0	15.0	-2.0	39 ²⁾
180	GR Observer 180	10.427	-10.600	1.500	0.0	360.0	15.0	-2.0	41 ²⁾
181	GR Observer 181	10.427	-8.480	1.500	0.0	360.0	15.0	-2.0	45 ²⁾
182	GR Observer 182	10.427	-6.360	1.500	0.0	360.0	15.0	-2.0	47 ²⁾
183	GR Observer 183	10.427	-4.240	1.500	0.0	360.0	15.0	-2.0	48 ²⁾
184	GR Observer 184	10.427	-2.120	1.500	0.0	360.0	15.0	-2.0	47 ²⁾

MIDSTREAM LIGHTING LIMITED
 WESSEX HOUSE
 1 CHESHAM STREET
 LONDON, SW 1X 8ND, UNITED KINGDOM

Operator MIDSTREAM LIGHTING LIMITED
 Telephone +44 (0)207 584 8310
 Fax
 e-Mail info@midstreamlighting.com

GR Calculation / GR Observer (Results Overview)

GR Observerlist

No.	Designation	Position [m]			Viewing sector [°]				Max
		X	Y	Z	Start	End	Increment	Slope angle	
185	GR Observer 185	10.427	0.000	1.500	0.0	360.0	15.0	-2.0	47 ²⁾
186	GR Observer 186	10.427	2.120	1.500	0.0	360.0	15.0	-2.0	48 ²⁾
187	GR Observer 187	10.427	4.240	1.500	0.0	360.0	15.0	-2.0	49 ²⁾
188	GR Observer 188	10.427	6.360	1.500	0.0	360.0	15.0	-2.0	48 ²⁾
189	GR Observer 189	10.427	8.480	1.500	0.0	360.0	15.0	-2.0	46 ²⁾
190	GR Observer 190	10.427	10.600	1.500	0.0	360.0	15.0	-2.0	43 ²⁾
191	GR Observer 191	10.427	12.720	1.500	0.0	360.0	15.0	-2.0	39 ²⁾
192	GR Observer 192	10.427	14.840	1.500	0.0	360.0	15.0	-2.0	36 ²⁾
193	GR Observer 193	8.356	-14.840	1.500	0.0	360.0	15.0	-2.0	38 ²⁾
194	GR Observer 194	8.356	-12.720	1.500	0.0	360.0	15.0	-2.0	39 ²⁾
195	GR Observer 195	8.356	-10.600	1.500	0.0	360.0	15.0	-2.0	42 ²⁾
196	GR Observer 196	8.356	-8.480	1.500	0.0	360.0	15.0	-2.0	45 ²⁾
197	GR Observer 197	8.356	-6.360	1.500	0.0	360.0	15.0	-2.0	46 ²⁾
198	GR Observer 198	8.356	-4.240	1.500	0.0	360.0	15.0	-2.0	47 ²⁾
199	GR Observer 199	8.356	-2.120	1.500	0.0	360.0	15.0	-2.0	46 ²⁾
200	GR Observer 200	8.356	0.000	1.500	0.0	360.0	15.0	-2.0	46 ²⁾
201	GR Observer 201	8.356	2.120	1.500	0.0	360.0	15.0	-2.0	48 ²⁾
202	GR Observer 202	8.356	4.240	1.500	0.0	360.0	15.0	-2.0	48 ²⁾
203	GR Observer 203	8.356	6.360	1.500	0.0	360.0	15.0	-2.0	48 ²⁾
204	GR Observer 204	8.356	8.480	1.500	0.0	360.0	15.0	-2.0	46 ²⁾
205	GR Observer 205	8.356	10.600	1.500	0.0	360.0	15.0	-2.0	45 ²⁾
206	GR Observer 206	8.356	12.720	1.500	0.0	360.0	15.0	-2.0	41 ²⁾
207	GR Observer 207	8.356	14.840	1.500	0.0	360.0	15.0	-2.0	36 ²⁾
208	GR Observer 208	35.411	-14.707	1.500	0.0	360.0	15.0	-2.0	34 ²⁾
209	GR Observer 209	35.394	-12.720	1.500	0.0	360.0	15.0	-2.0	35 ²⁾
210	GR Observer 210	35.394	-10.600	1.500	0.0	360.0	15.0	-2.0	38 ²⁾
211	GR Observer 211	35.394	-8.480	1.500	0.0	360.0	15.0	-2.0	41 ²⁾
212	GR Observer 212	35.394	-6.360	1.500	0.0	360.0	15.0	-2.0	42 ²⁾
213	GR Observer 213	35.394	-4.240	1.500	0.0	360.0	15.0	-2.0	42 ²⁾
214	GR Observer 214	35.394	4.240	1.500	0.0	360.0	15.0	-2.0	43 ²⁾
215	GR Observer 215	35.394	6.360	1.500	0.0	360.0	15.0	-2.0	42 ²⁾
216	GR Observer 216	35.394	8.480	1.500	0.0	360.0	15.0	-2.0	41 ²⁾
217	GR Observer 217	35.394	10.600	1.500	0.0	360.0	15.0	-2.0	38 ²⁾
218	GR Observer 218	35.394	12.720	1.500	0.0	360.0	15.0	-2.0	33 ²⁾
219	GR Observer 219	35.394	14.840	1.500	0.0	360.0	15.0	-2.0	32 ²⁾
220	GR Observer 220	33.340	-14.707	1.500	0.0	360.0	15.0	-2.0	36 ²⁾

MIDSTREAM LIGHTING LIMITED
 WESSEX HOUSE
 1 CHESHAM STREET
 LONDON, SW 1X 8ND, UNITED KINGDOM

Operator MIDSTREAM LIGHTING LIMITED
 Telephone +44 (0)207 584 8310
 Fax
 e-Mail info@midstreamlighting.com

GR Calculation / GR Observer (Results Overview)

GR Observerlist

No.	Designation	Position [m]			Viewing sector [°]				Max
		X	Y	Z	Start	End	Increment	Slope angle	
221	GR Observer 221	33.323	-12.720	1.500	0.0	360.0	15.0	-2.0	37 ²⁾
222	GR Observer 222	33.323	-10.600	1.500	0.0	360.0	15.0	-2.0	38 ²⁾
223	GR Observer 223	33.323	-8.480	1.500	0.0	360.0	15.0	-2.0	42 ²⁾
224	GR Observer 224	33.323	-6.360	1.500	0.0	360.0	15.0	-2.0	44 ²⁾
225	GR Observer 225	33.323	-4.240	1.500	0.0	360.0	15.0	-2.0	45 ²⁾
226	GR Observer 226	33.323	-2.120	1.500	0.0	360.0	15.0	-2.0	45 ²⁾
227	GR Observer 227	33.323	0.000	1.500	0.0	360.0	15.0	-2.0	43 ²⁾
228	GR Observer 228	33.323	2.120	1.500	0.0	360.0	15.0	-2.0	45 ²⁾
229	GR Observer 229	33.323	4.240	1.500	0.0	360.0	15.0	-2.0	46 ²⁾
230	GR Observer 230	33.323	6.360	1.500	0.0	360.0	15.0	-2.0	44 ²⁾
231	GR Observer 231	33.323	8.480	1.500	0.0	360.0	15.0	-2.0	42 ²⁾
232	GR Observer 232	33.323	10.600	1.500	0.0	360.0	15.0	-2.0	38 ²⁾
233	GR Observer 233	33.323	12.720	1.500	0.0	360.0	15.0	-2.0	35 ²⁾
234	GR Observer 234	33.323	14.840	1.500	0.0	360.0	15.0	-2.0	34 ²⁾
235	GR Observer 235	31.268	-14.707	1.500	0.0	360.0	15.0	-2.0	38 ²⁾
236	GR Observer 236	31.251	-12.720	1.500	0.0	360.0	15.0	-2.0	39 ²⁾
237	GR Observer 237	31.251	-10.600	1.500	0.0	360.0	15.0	-2.0	39 ²⁾
238	GR Observer 238	31.251	-8.480	1.500	0.0	360.0	15.0	-2.0	40 ²⁾
239	GR Observer 239	31.251	-6.360	1.500	0.0	360.0	15.0	-2.0	43 ²⁾
240	GR Observer 240	31.251	-4.240	1.500	0.0	360.0	15.0	-2.0	44 ²⁾
241	GR Observer 241	31.251	-2.120	1.500	0.0	360.0	15.0	-2.0	44 ²⁾
242	GR Observer 242	31.251	0.000	1.500	0.0	360.0	15.0	-2.0	44 ²⁾
243	GR Observer 243	31.251	2.120	1.500	0.0	360.0	15.0	-2.0	45 ²⁾
244	GR Observer 244	31.251	4.240	1.500	0.0	360.0	15.0	-2.0	45 ²⁾
245	GR Observer 245	31.251	6.360	1.500	0.0	360.0	15.0	-2.0	43 ²⁾
246	GR Observer 246	31.251	8.480	1.500	0.0	360.0	15.0	-2.0	39 ²⁾
247	GR Observer 247	31.251	10.600	1.500	0.0	360.0	15.0	-2.0	38 ²⁾
248	GR Observer 248	31.251	12.720	1.500	0.0	360.0	15.0	-2.0	37 ²⁾
249	GR Observer 249	31.251	14.840	1.500	0.0	360.0	15.0	-2.0	36 ²⁾
250	GR Observer 250	29.197	-14.707	1.500	0.0	360.0	15.0	-2.0	38 ²⁾
251	GR Observer 251	29.180	-12.720	1.500	0.0	360.0	15.0	-2.0	39 ²⁾
252	GR Observer 252	29.180	-10.600	1.500	0.0	360.0	15.0	-2.0	40 ²⁾
253	GR Observer 253	29.180	-8.480	1.500	0.0	360.0	15.0	-2.0	42 ²⁾
254	GR Observer 254	29.180	-6.360	1.500	0.0	360.0	15.0	-2.0	43 ²⁾
255	GR Observer 255	29.180	-4.240	1.500	0.0	360.0	15.0	-2.0	44 ²⁾
256	GR Observer 256	29.180	-2.120	1.500	0.0	360.0	15.0	-2.0	45 ²⁾

MIDSTREAM LIGHTING LIMITED
 WESSEX HOUSE
 1 CHESHAM STREET
 LONDON, SW 1X 8ND, UNITED KINGDOM

Operator MIDSTREAM LIGHTING LIMITED
 Telephone +44 (0)207 584 8310
 Fax
 e-Mail info@midstreamlighting.com

GR Calculation / GR Observer (Results Overview)

GR Observerlist

No.	Designation	Position [m]			Viewing sector [°]				Max
		X	Y	Z	Start	End	Increment	Slope angle	
257	GR Observer 257	29.180	0.000	1.500	0.0	360.0	15.0	-2.0	45 ²⁾
258	GR Observer 258	29.180	2.120	1.500	0.0	360.0	15.0	-2.0	45 ²⁾
259	GR Observer 259	29.180	4.240	1.500	0.0	360.0	15.0	-2.0	45 ²⁾
260	GR Observer 260	29.180	6.360	1.500	0.0	360.0	15.0	-2.0	42 ²⁾
261	GR Observer 261	29.180	8.480	1.500	0.0	360.0	15.0	-2.0	40 ²⁾
262	GR Observer 262	29.180	10.600	1.500	0.0	360.0	15.0	-2.0	39 ²⁾
263	GR Observer 263	29.180	12.720	1.500	0.0	360.0	15.0	-2.0	37 ²⁾
264	GR Observer 264	29.180	14.840	1.500	0.0	360.0	15.0	-2.0	36 ²⁾
265	GR Observer 265	27.125	-14.707	1.500	0.0	360.0	15.0	-2.0	37 ²⁾
266	GR Observer 266	27.109	-12.720	1.500	0.0	360.0	15.0	-2.0	38 ²⁾
267	GR Observer 267	27.109	-10.600	1.500	0.0	360.0	15.0	-2.0	40 ²⁾
268	GR Observer 268	27.109	-8.480	1.500	0.0	360.0	15.0	-2.0	42 ²⁾
269	GR Observer 269	27.109	-6.360	1.500	0.0	360.0	15.0	-2.0	45 ²⁾
270	GR Observer 270	27.109	-4.240	1.500	0.0	360.0	15.0	-2.0	47 ²⁾
271	GR Observer 271	27.109	-2.120	1.500	0.0	360.0	15.0	-2.0	47 ²⁾
272	GR Observer 272	27.109	0.000	1.500	0.0	360.0	15.0	-2.0	47 ²⁾
273	GR Observer 273	27.109	2.120	1.500	0.0	360.0	15.0	-2.0	48 ²⁾
274	GR Observer 274	27.109	4.240	1.500	0.0	360.0	15.0	-2.0	48 ²⁾
275	GR Observer 275	27.109	6.360	1.500	0.0	360.0	15.0	-2.0	46 ²⁾
276	GR Observer 276	27.109	8.480	1.500	0.0	360.0	15.0	-2.0	43 ²⁾
277	GR Observer 277	27.109	10.600	1.500	0.0	360.0	15.0	-2.0	40 ²⁾
278	GR Observer 278	27.109	12.720	1.500	0.0	360.0	15.0	-2.0	37 ²⁾
279	GR Observer 279	27.109	14.840	1.500	0.0	360.0	15.0	-2.0	35 ²⁾
280	GR Observer 280	25.054	-14.707	1.500	0.0	360.0	15.0	-2.0	37 ²⁾
281	GR Observer 281	25.037	-12.720	1.500	0.0	360.0	15.0	-2.0	38 ²⁾
282	GR Observer 282	25.037	-10.600	1.500	0.0	360.0	15.0	-2.0	42 ²⁾
283	GR Observer 283	25.037	-8.480	1.500	0.0	360.0	15.0	-2.0	45 ²⁾
284	GR Observer 284	25.037	-6.360	1.500	0.0	360.0	15.0	-2.0	47 ²⁾
285	GR Observer 285	25.037	-4.240	1.500	0.0	360.0	15.0	-2.0	48 ²⁾
286	GR Observer 286	25.037	-2.120	1.500	0.0	360.0	15.0	-2.0	47 ²⁾
287	GR Observer 287	25.037	0.000	1.500	0.0	360.0	15.0	-2.0	47 ²⁾
288	GR Observer 288	25.037	2.120	1.500	0.0	360.0	15.0	-2.0	48 ²⁾
289	GR Observer 289	25.037	4.240	1.500	0.0	360.0	15.0	-2.0	49 ²⁾
290	GR Observer 290	25.037	6.360	1.500	0.0	360.0	15.0	-2.0	48 ²⁾
291	GR Observer 291	25.037	8.480	1.500	0.0	360.0	15.0	-2.0	46 ²⁾
292	GR Observer 292	25.037	10.600	1.500	0.0	360.0	15.0	-2.0	44 ²⁾

MIDSTREAM LIGHTING LIMITED
 WESSEX HOUSE
 1 CHESHAM STREET
 LONDON, SW 1X 8ND, UNITED KINGDOM

Operator MIDSTREAM LIGHTING LIMITED
 Telephone +44 (0)207 584 8310
 Fax
 e-Mail info@midstreamlighting.com

GR Calculation / GR Observer (Results Overview)

GR Observerlist

No.	Designation	Position [m]			Viewing sector [°]				Max
		X	Y	Z	Start	End	Increment	Slope angle	
293	GR Observer 293	25.037	12.720	1.500	0.0	360.0	15.0	-2.0	39 ²⁾
294	GR Observer 294	25.037	14.840	1.500	0.0	360.0	15.0	-2.0	35 ²⁾
295	GR Observer 295	22.982	-14.707	1.500	0.0	360.0	15.0	-2.0	38 ²⁾
296	GR Observer 296	22.966	-12.720	1.500	0.0	360.0	15.0	-2.0	39 ²⁾
297	GR Observer 297	22.966	-10.600	1.500	0.0	360.0	15.0	-2.0	42 ²⁾
298	GR Observer 298	22.966	-8.480	1.500	0.0	360.0	15.0	-2.0	44 ²⁾
299	GR Observer 299	22.966	-6.360	1.500	0.0	360.0	15.0	-2.0	46 ²⁾
300	GR Observer 300	22.966	-4.240	1.500	0.0	360.0	15.0	-2.0	46 ²⁾
301	GR Observer 301	22.966	-2.120	1.500	0.0	360.0	15.0	-2.0	46 ²⁾
302	GR Observer 302	22.966	0.000	1.500	0.0	360.0	15.0	-2.0	46 ²⁾
303	GR Observer 303	22.966	2.120	1.500	0.0	360.0	15.0	-2.0	47 ²⁾
304	GR Observer 304	22.966	4.240	1.500	0.0	360.0	15.0	-2.0	48 ²⁾
305	GR Observer 305	22.966	6.360	1.500	0.0	360.0	15.0	-2.0	47 ²⁾
306	GR Observer 306	22.966	8.480	1.500	0.0	360.0	15.0	-2.0	46 ²⁾
307	GR Observer 307	22.966	10.600	1.500	0.0	360.0	15.0	-2.0	44 ²⁾
308	GR Observer 308	22.966	12.720	1.500	0.0	360.0	15.0	-2.0	41 ²⁾
309	GR Observer 309	22.966	14.840	1.500	0.0	360.0	15.0	-2.0	36 ²⁾
310	GR Observer 310	25.523	25.898	1.500	0.0	360.0	15.0	-2.0	33 ²⁾
311	GR Observer 311	25.913	27.982	1.500	0.0	360.0	15.0	-2.0	39 ²⁾
312	GR Observer 312	26.303	30.065	1.500	0.0	360.0	15.0	-2.0	42 ²⁾
313	GR Observer 313	26.693	32.149	1.500	0.0	360.0	15.0	-2.0	43 ²⁾
314	GR Observer 314	27.083	34.233	1.500	0.0	360.0	15.0	-2.0	44 ²⁾
315	GR Observer 315	27.473	36.317	1.500	0.0	360.0	15.0	-2.0	44 ²⁾
316	GR Observer 316	29.033	44.652	1.500	0.0	360.0	15.0	-2.0	43 ²⁾
317	GR Observer 317	29.423	46.736	1.500	0.0	360.0	15.0	-2.0	42 ²⁾
318	GR Observer 318	29.813	48.820	1.500	0.0	360.0	15.0	-2.0	41 ²⁾
319	GR Observer 319	30.203	50.904	1.500	0.0	360.0	15.0	-2.0	38 ²⁾
320	GR Observer 320	30.593	52.987	1.500	0.0	360.0	15.0	-2.0	35 ²⁾
321	GR Observer 321	30.983	55.071	1.500	0.0	360.0	15.0	-2.0	35 ²⁾
322	GR Observer 322	23.417	26.292	1.500	0.0	360.0	15.0	-2.0	35 ²⁾
323	GR Observer 323	23.807	28.376	1.500	0.0	360.0	15.0	-2.0	39 ²⁾
324	GR Observer 324	24.197	30.460	1.500	0.0	360.0	15.0	-2.0	42 ²⁾
325	GR Observer 325	24.587	32.543	1.500	0.0	360.0	15.0	-2.0	44 ²⁾
326	GR Observer 326	24.977	34.627	1.500	0.0	360.0	15.0	-2.0	46 ²⁾
327	GR Observer 327	25.367	36.711	1.500	0.0	360.0	15.0	-2.0	47 ²⁾
328	GR Observer 328	25.757	38.795	1.500	0.0	360.0	15.0	-2.0	46 ²⁾

MIDSTREAM LIGHTING LIMITED
 WESSEX HOUSE
 1 CHESHAM STREET
 LONDON, SW 1X 8ND, UNITED KINGDOM

Operator MIDSTREAM LIGHTING LIMITED
 Telephone +44 (0)207 584 8310
 Fax
 e-Mail info@midstreamlighting.com

GR Calculation / GR Observer (Results Overview)

GR Observerlist

No.	Designation	Position [m]			Viewing sector [°]				Max
		X	Y	Z	Start	End	Increment	Slope angle	
329	GR Observer 329	26.147	40.879	1.500	0.0	360.0	15.0	-2.0	45 ²⁾
330	GR Observer 330	26.537	42.962	1.500	0.0	360.0	15.0	-2.0	44 ²⁾
331	GR Observer 331	26.927	45.046	1.500	0.0	360.0	15.0	-2.0	45 ²⁾
332	GR Observer 332	27.317	47.130	1.500	0.0	360.0	15.0	-2.0	44 ²⁾
333	GR Observer 333	27.706	49.214	1.500	0.0	360.0	15.0	-2.0	42 ²⁾
334	GR Observer 334	28.096	51.298	1.500	0.0	360.0	15.0	-2.0	39 ²⁾
335	GR Observer 335	28.486	53.382	1.500	0.0	360.0	15.0	-2.0	37 ²⁾
336	GR Observer 336	28.876	55.465	1.500	0.0	360.0	15.0	-2.0	37 ²⁾
337	GR Observer 337	21.310	26.686	1.500	0.0	360.0	15.0	-2.0	36 ²⁾
338	GR Observer 338	21.700	28.770	1.500	0.0	360.0	15.0	-2.0	36 ²⁾
339	GR Observer 339	22.090	30.854	1.500	0.0	360.0	15.0	-2.0	39 ²⁾
340	GR Observer 340	22.480	32.938	1.500	0.0	360.0	15.0	-2.0	42 ²⁾
341	GR Observer 341	22.870	35.021	1.500	0.0	360.0	15.0	-2.0	45 ²⁾
342	GR Observer 342	23.260	37.105	1.500	0.0	360.0	15.0	-2.0	46 ²⁾
343	GR Observer 343	23.650	39.189	1.500	0.0	360.0	15.0	-2.0	46 ²⁾
344	GR Observer 344	24.040	41.273	1.500	0.0	360.0	15.0	-2.0	45 ²⁾
345	GR Observer 345	24.430	43.357	1.500	0.0	360.0	15.0	-2.0	45 ²⁾
346	GR Observer 346	24.820	45.440	1.500	0.0	360.0	15.0	-2.0	45 ²⁾
347	GR Observer 347	25.210	47.524	1.500	0.0	360.0	15.0	-2.0	43 ²⁾
348	GR Observer 348	25.600	49.608	1.500	0.0	360.0	15.0	-2.0	41 ²⁾
349	GR Observer 349	25.990	51.692	1.500	0.0	360.0	15.0	-2.0	39 ²⁾
350	GR Observer 350	26.380	53.776	1.500	0.0	360.0	15.0	-2.0	38 ²⁾
351	GR Observer 351	26.770	55.860	1.500	0.0	360.0	15.0	-2.0	37 ²⁾
352	GR Observer 352	19.204	27.080	1.500	0.0	360.0	15.0	-2.0	37 ²⁾
353	GR Observer 353	19.594	29.164	1.500	0.0	360.0	15.0	-2.0	38 ²⁾
354	GR Observer 354	19.984	31.248	1.500	0.0	360.0	15.0	-2.0	39 ²⁾
355	GR Observer 355	20.374	33.332	1.500	0.0	360.0	15.0	-2.0	40 ²⁾
356	GR Observer 356	20.764	35.416	1.500	0.0	360.0	15.0	-2.0	41 ²⁾
357	GR Observer 357	21.154	37.499	1.500	0.0	360.0	15.0	-2.0	44 ²⁾
358	GR Observer 358	21.544	39.583	1.500	0.0	360.0	15.0	-2.0	45 ²⁾
359	GR Observer 359	21.934	41.667	1.500	0.0	360.0	15.0	-2.0	45 ²⁾
360	GR Observer 360	22.324	43.751	1.500	0.0	360.0	15.0	-2.0	45 ²⁾
361	GR Observer 361	22.714	45.835	1.500	0.0	360.0	15.0	-2.0	44 ²⁾
362	GR Observer 362	23.104	47.918	1.500	0.0	360.0	15.0	-2.0	42 ²⁾
363	GR Observer 363	23.494	50.002	1.500	0.0	360.0	15.0	-2.0	41 ²⁾
364	GR Observer 364	23.884	52.086	1.500	0.0	360.0	15.0	-2.0	39 ²⁾

MIDSTREAM LIGHTING LIMITED
 WESSEX HOUSE
 1 CHESHAM STREET
 LONDON, SW 1X 8ND, UNITED KINGDOM

Operator MIDSTREAM LIGHTING LIMITED
 Telephone +44 (0)207 584 8310
 Fax
 e-Mail info@midstreamlighting.com

GR Calculation / GR Observer (Results Overview)

GR Observerlist

No.	Designation	Position [m]			Viewing sector [°]				Max
		X	Y	Z	Start	End	Increment	Slope angle	
365	GR Observer 365	24.274	54.170	1.500	0.0	360.0	15.0	-2.0	38 ²⁾
366	GR Observer 366	24.664	56.254	1.500	0.0	360.0	15.0	-2.0	38 ²⁾
367	GR Observer 367	17.098	27.474	1.500	0.0	360.0	15.0	-2.0	37 ²⁾
368	GR Observer 368	17.488	29.558	1.500	0.0	360.0	15.0	-2.0	39 ²⁾
369	GR Observer 369	17.878	31.642	1.500	0.0	360.0	15.0	-2.0	40 ²⁾
370	GR Observer 370	18.268	33.726	1.500	0.0	360.0	15.0	-2.0	43 ²⁾
371	GR Observer 371	18.658	35.810	1.500	0.0	360.0	15.0	-2.0	46 ²⁾
372	GR Observer 372	19.048	37.894	1.500	0.0	360.0	15.0	-2.0	48 ²⁾
373	GR Observer 373	19.438	39.977	1.500	0.0	360.0	15.0	-2.0	47 ²⁾
374	GR Observer 374	19.828	42.061	1.500	0.0	360.0	15.0	-2.0	46 ²⁾
375	GR Observer 375	20.218	44.145	1.500	0.0	360.0	15.0	-2.0	46 ²⁾
376	GR Observer 376	20.608	46.229	1.500	0.0	360.0	15.0	-2.0	46 ²⁾
377	GR Observer 377	20.998	48.313	1.500	0.0	360.0	15.0	-2.0	45 ²⁾
378	GR Observer 378	21.388	50.396	1.500	0.0	360.0	15.0	-2.0	42 ²⁾
379	GR Observer 379	21.778	52.480	1.500	0.0	360.0	15.0	-2.0	41 ²⁾
380	GR Observer 380	22.168	54.564	1.500	0.0	360.0	15.0	-2.0	40 ²⁾
381	GR Observer 381	22.558	56.648	1.500	0.0	360.0	15.0	-2.0	39 ²⁾
382	GR Observer 382	14.992	27.869	1.500	0.0	360.0	15.0	-2.0	36 ²⁾
383	GR Observer 383	15.382	29.952	1.500	0.0	360.0	15.0	-2.0	40 ²⁾
384	GR Observer 384	15.772	32.036	1.500	0.0	360.0	15.0	-2.0	44 ²⁾
385	GR Observer 385	16.162	34.120	1.500	0.0	360.0	15.0	-2.0	46 ²⁾
386	GR Observer 386	16.551	36.204	1.500	0.0	360.0	15.0	-2.0	48 ²⁾
387	GR Observer 387	16.941	38.288	1.500	0.0	360.0	15.0	-2.0	48 ²⁾
388	GR Observer 388	17.331	40.372	1.500	0.0	360.0	15.0	-2.0	48 ²⁾
389	GR Observer 389	17.721	42.455	1.500	0.0	360.0	15.0	-2.0	47 ²⁾
390	GR Observer 390	18.111	44.539	1.500	0.0	360.0	15.0	-2.0	48 ²⁾
391	GR Observer 391	18.501	46.623	1.500	0.0	360.0	15.0	-2.0	48 ²⁾
392	GR Observer 392	18.891	48.707	1.500	0.0	360.0	15.0	-2.0	47 ²⁾
393	GR Observer 393	19.281	50.791	1.500	0.0	360.0	15.0	-2.0	45 ²⁾
394	GR Observer 394	19.671	52.874	1.500	0.0	360.0	15.0	-2.0	42 ²⁾
395	GR Observer 395	20.061	54.958	1.500	0.0	360.0	15.0	-2.0	40 ²⁾
396	GR Observer 396	20.451	57.042	1.500	0.0	360.0	15.0	-2.0	39 ²⁾
397	GR Observer 397	12.885	28.263	1.500	0.0	360.0	15.0	-2.0	36 ²⁾
398	GR Observer 398	13.275	30.347	1.500	0.0	360.0	15.0	-2.0	42 ²⁾
399	GR Observer 399	13.665	32.430	1.500	0.0	360.0	15.0	-2.0	45 ²⁾
400	GR Observer 400	14.055	34.514	1.500	0.0	360.0	15.0	-2.0	47 ²⁾

MIDSTREAM LIGHTING LIMITED
 WESSEX HOUSE
 1 CHESHAM STREET
 LONDON, SW 1X 8ND, UNITED KINGDOM

Operator MIDSTREAM LIGHTING LIMITED
 Telephone +44 (0)207 584 8310
 Fax
 e-Mail info@midstreamlighting.com

GR Calculation / GR Observer (Results Overview)

GR Observerlist

No.	Designation	Position [m]			Viewing sector [°]				Max
		X	Y	Z	Start	End	Increment	Slope angle	
401	GR Observer 401	14.445	36.598	1.500	0.0	360.0	15.0	-2.0	48 ²⁾
402	GR Observer 402	14.835	38.682	1.500	0.0	360.0	15.0	-2.0	49 ²⁾
403	GR Observer 403	15.225	40.766	1.500	0.0	360.0	15.0	-2.0	48 ²⁾
404	GR Observer 404	15.615	42.850	1.500	0.0	360.0	15.0	-2.0	47 ²⁾
405	GR Observer 405	16.005	44.933	1.500	0.0	360.0	15.0	-2.0	46 ²⁾
406	GR Observer 406	16.395	47.017	1.500	0.0	360.0	15.0	-2.0	47 ²⁾
407	GR Observer 407	16.785	49.101	1.500	0.0	360.0	15.0	-2.0	47 ²⁾
408	GR Observer 408	17.175	51.185	1.500	0.0	360.0	15.0	-2.0	46 ²⁾
409	GR Observer 409	17.565	53.269	1.500	0.0	360.0	15.0	-2.0	43 ²⁾
410	GR Observer 410	17.955	55.352	1.500	0.0	360.0	15.0	-2.0	39 ²⁾
411	GR Observer 411	18.345	57.436	1.500	0.0	360.0	15.0	-2.0	39 ²⁾
412	GR Observer 412	10.587	28.667	1.500	0.0	360.0	15.0	-2.0	37 ²⁾
413	GR Observer 413	10.977	30.751	1.500	0.0	360.0	15.0	-2.0	43 ²⁾
414	GR Observer 414	11.367	32.834	1.500	0.0	360.0	15.0	-2.0	46 ²⁾
415	GR Observer 415	11.757	34.918	1.500	0.0	360.0	15.0	-2.0	47 ²⁾
416	GR Observer 416	12.147	37.002	1.500	0.0	360.0	15.0	-2.0	48 ²⁾
417	GR Observer 417	12.537	39.086	1.500	0.0	360.0	15.0	-2.0	48 ²⁾
418	GR Observer 418	12.927	41.170	1.500	0.0	360.0	15.0	-2.0	48 ²⁾
419	GR Observer 419	13.317	43.253	1.500	0.0	360.0	15.0	-2.0	46 ²⁾
420	GR Observer 420	13.707	45.337	1.500	0.0	360.0	15.0	-2.0	47 ²⁾
421	GR Observer 421	14.097	47.421	1.500	0.0	360.0	15.0	-2.0	48 ²⁾
422	GR Observer 422	14.487	49.505	1.500	0.0	360.0	15.0	-2.0	47 ²⁾
423	GR Observer 423	14.877	51.589	1.500	0.0	360.0	15.0	-2.0	46 ²⁾
424	GR Observer 424	15.267	53.673	1.500	0.0	360.0	15.0	-2.0	43 ²⁾
425	GR Observer 425	15.657	55.756	1.500	0.0	360.0	15.0	-2.0	39 ²⁾
426	GR Observer 426	16.047	57.840	1.500	0.0	360.0	15.0	-2.0	38 ²⁾
427	GR Observer 427	8.481	29.061	1.500	0.0	360.0	15.0	-2.0	37 ²⁾
428	GR Observer 428	8.871	31.145	1.500	0.0	360.0	15.0	-2.0	42 ²⁾
429	GR Observer 429	9.261	33.229	1.500	0.0	360.0	15.0	-2.0	45 ²⁾
430	GR Observer 430	9.651	35.312	1.500	0.0	360.0	15.0	-2.0	47 ²⁾
431	GR Observer 431	10.041	37.396	1.500	0.0	360.0	15.0	-2.0	49 ²⁾
432	GR Observer 432	10.431	39.480	1.500	0.0	360.0	15.0	-2.0	49 ²⁾
433	GR Observer 433	10.821	41.564	1.500	0.0	360.0	15.0	-2.0	49 ²⁾
434	GR Observer 434	11.211	43.648	1.500	0.0	360.0	15.0	-2.0	48 ²⁾
435	GR Observer 435	11.601	45.731	1.500	0.0	360.0	15.0	-2.0	47 ²⁾
436	GR Observer 436	11.991	47.815	1.500	0.0	360.0	15.0	-2.0	47 ²⁾

MIDSTREAM LIGHTING LIMITED
 WESSEX HOUSE
 1 CHESHAM STREET
 LONDON, SW 1X 8ND, UNITED KINGDOM

Operator MIDSTREAM LIGHTING LIMITED
 Telephone +44 (0)207 584 8310
 Fax
 e-Mail info@midstreamlighting.com

GR Calculation / GR Observer (Results Overview)

GR Observerlist

No.	Designation	Position [m]			Start	Viewing sector [°]			Max
		X	Y	Z		End	Increment	Slope angle	
437	GR Observer 437	12.381	49.899	1.500	0.0	360.0	15.0	-2.0	47 ²⁾
438	GR Observer 438	12.770	51.983	1.500	0.0	360.0	15.0	-2.0	45 ²⁾
439	GR Observer 439	13.160	54.067	1.500	0.0	360.0	15.0	-2.0	42 ²⁾
440	GR Observer 440	13.550	56.151	1.500	0.0	360.0	15.0	-2.0	39 ²⁾
441	GR Observer 441	13.940	58.234	1.500	0.0	360.0	15.0	-2.0	38 ²⁾
442	GR Observer 442	6.374	29.455	1.500	0.0	360.0	15.0	-2.0	37 ²⁾
443	GR Observer 443	6.764	31.539	1.500	0.0	360.0	15.0	-2.0	38 ²⁾
444	GR Observer 444	7.154	33.623	1.500	0.0	360.0	15.0	-2.0	41 ²⁾
445	GR Observer 445	7.544	35.707	1.500	0.0	360.0	15.0	-2.0	44 ²⁾
446	GR Observer 446	7.934	37.790	1.500	0.0	360.0	15.0	-2.0	47 ²⁾
447	GR Observer 447	8.324	39.874	1.500	0.0	360.0	15.0	-2.0	48 ²⁾
448	GR Observer 448	8.714	41.958	1.500	0.0	360.0	15.0	-2.0	47 ²⁾
449	GR Observer 449	9.104	44.042	1.500	0.0	360.0	15.0	-2.0	47 ²⁾
450	GR Observer 450	9.494	46.126	1.500	0.0	360.0	15.0	-2.0	47 ²⁾
451	GR Observer 451	9.884	48.209	1.500	0.0	360.0	15.0	-2.0	47 ²⁾
452	GR Observer 452	10.274	50.293	1.500	0.0	360.0	15.0	-2.0	45 ²⁾
453	GR Observer 453	10.664	52.377	1.500	0.0	360.0	15.0	-2.0	43 ²⁾
454	GR Observer 454	11.054	54.461	1.500	0.0	360.0	15.0	-2.0	42 ²⁾
455	GR Observer 455	11.444	56.545	1.500	0.0	360.0	15.0	-2.0	41 ²⁾
456	GR Observer 456	11.834	58.629	1.500	0.0	360.0	15.0	-2.0	39 ²⁾
457	GR Observer 457	4.268	29.849	1.500	0.0	360.0	15.0	-2.0	37 ²⁾
458	GR Observer 458	4.658	31.933	1.500	0.0	360.0	15.0	-2.0	38 ²⁾
459	GR Observer 459	5.048	34.017	1.500	0.0	360.0	15.0	-2.0	39 ²⁾
460	GR Observer 460	5.438	36.101	1.500	0.0	360.0	15.0	-2.0	40 ²⁾
461	GR Observer 461	5.828	38.185	1.500	0.0	360.0	15.0	-2.0	42 ²⁾
462	GR Observer 462	6.218	40.268	1.500	0.0	360.0	15.0	-2.0	45 ²⁾
463	GR Observer 463	6.608	42.352	1.500	0.0	360.0	15.0	-2.0	46 ²⁾
464	GR Observer 464	6.998	44.436	1.500	0.0	360.0	15.0	-2.0	45 ²⁾
465	GR Observer 465	7.388	46.520	1.500	0.0	360.0	15.0	-2.0	44 ²⁾
466	GR Observer 466	7.778	48.604	1.500	0.0	360.0	15.0	-2.0	44 ²⁾
467	GR Observer 467	8.168	50.687	1.500	0.0	360.0	15.0	-2.0	43 ²⁾
468	GR Observer 468	8.558	52.771	1.500	0.0	360.0	15.0	-2.0	42 ²⁾
469	GR Observer 469	8.948	54.855	1.500	0.0	360.0	15.0	-2.0	41 ²⁾
470	GR Observer 470	9.338	56.939	1.500	0.0	360.0	15.0	-2.0	40 ²⁾
471	GR Observer 471	9.728	59.023	1.500	0.0	360.0	15.0	-2.0	39 ²⁾
472	GR Observer 472	2.162	30.243	1.500	0.0	360.0	15.0	-2.0	38 ²⁾

MIDSTREAM LIGHTING LIMITED
 WESSEX HOUSE
 1 CHESHAM STREET
 LONDON, SW 1X 8ND, UNITED KINGDOM

Operator MIDSTREAM LIGHTING LIMITED
 Telephone +44 (0)207 584 8310
 Fax
 e-Mail info@midstreamlighting.com

GR Calculation / GR Observer (Results Overview)

GR Observerlist

No.	Designation	Position [m]			Viewing sector [°]				Max
		X	Y	Z	Start	End	Increment	Slope angle	
473	GR Observer 473	2.552	32.327	1.500	0.0	360.0	15.0	-2.0	39 ²⁾
474	GR Observer 474	2.942	34.411	1.500	0.0	360.0	15.0	-2.0	40 ²⁾
475	GR Observer 475	3.332	36.495	1.500	0.0	360.0	15.0	-2.0	42 ²⁾
476	GR Observer 476	3.722	38.579	1.500	0.0	360.0	15.0	-2.0	45 ²⁾
477	GR Observer 477	4.112	40.663	1.500	0.0	360.0	15.0	-2.0	47 ²⁾
478	GR Observer 478	4.502	42.746	1.500	0.0	360.0	15.0	-2.0	47 ²⁾
479	GR Observer 479	4.892	44.830	1.500	0.0	360.0	15.0	-2.0	46 ²⁾
480	GR Observer 480	5.282	46.914	1.500	0.0	360.0	15.0	-2.0	46 ²⁾
481	GR Observer 481	5.672	48.998	1.500	0.0	360.0	15.0	-2.0	46 ²⁾
482	GR Observer 482	6.062	51.082	1.500	0.0	360.0	15.0	-2.0	45 ²⁾
483	GR Observer 483	6.452	53.165	1.500	0.0	360.0	15.0	-2.0	42 ²⁾
484	GR Observer 484	6.842	55.249	1.500	0.0	360.0	15.0	-2.0	40 ²⁾
485	GR Observer 485	7.232	57.333	1.500	0.0	360.0	15.0	-2.0	39 ²⁾
486	GR Observer 486	7.622	59.417	1.500	0.0	360.0	15.0	-2.0	39 ²⁾
487	GR Observer 487	0.056	30.638	1.500	0.0	360.0	15.0	-2.0	36 ²⁾
488	GR Observer 488	0.446	32.721	1.500	0.0	360.0	15.0	-2.0	38 ²⁾
489	GR Observer 489	0.836	34.805	1.500	0.0	360.0	15.0	-2.0	43 ²⁾
490	GR Observer 490	1.226	36.889	1.500	0.0	360.0	15.0	-2.0	46 ²⁾
491	GR Observer 491	1.615	38.973	1.500	0.0	360.0	15.0	-2.0	47 ²⁾
492	GR Observer 492	2.005	41.057	1.500	0.0	360.0	15.0	-2.0	48 ²⁾
493	GR Observer 493	2.395	43.141	1.500	0.0	360.0	15.0	-2.0	47 ²⁾
494	GR Observer 494	2.785	45.224	1.500	0.0	360.0	15.0	-2.0	47 ²⁾
495	GR Observer 495	3.175	47.308	1.500	0.0	360.0	15.0	-2.0	48 ²⁾
496	GR Observer 496	3.565	49.392	1.500	0.0	360.0	15.0	-2.0	48 ²⁾
497	GR Observer 497	3.955	51.476	1.500	0.0	360.0	15.0	-2.0	47 ²⁾
498	GR Observer 498	4.345	53.560	1.500	0.0	360.0	15.0	-2.0	45 ²⁾
499	GR Observer 499	4.735	55.643	1.500	0.0	360.0	15.0	-2.0	42 ²⁾
500	GR Observer 500	5.125	57.727	1.500	0.0	360.0	15.0	-2.0	39 ²⁾
501	GR Observer 501	5.515	59.811	1.500	0.0	360.0	15.0	-2.0	38 ²⁾
502	GR Observer 502	-2.051	31.032	1.500	0.0	360.0	15.0	-2.0	36 ²⁾
503	GR Observer 503	-1.661	33.116	1.500	0.0	360.0	15.0	-2.0	40 ²⁾
504	GR Observer 504	-1.271	35.199	1.500	0.0	360.0	15.0	-2.0	44 ²⁾
505	GR Observer 505	-0.881	37.283	1.500	0.0	360.0	15.0	-2.0	46 ²⁾
506	GR Observer 506	-0.491	39.367	1.500	0.0	360.0	15.0	-2.0	47 ²⁾
507	GR Observer 507	-0.101	41.451	1.500	0.0	360.0	15.0	-2.0	48 ²⁾
508	GR Observer 508	0.289	43.535	1.500	0.0	360.0	15.0	-2.0	48 ²⁾

MIDSTREAM LIGHTING LIMITED
 WESSEX HOUSE
 1 CHESHAM STREET
 LONDON, SW 1X 8ND, UNITED KINGDOM

Operator MIDSTREAM LIGHTING LIMITED
 Telephone +44 (0)207 584 8310
 Fax
 e-Mail info@midstreamlighting.com

GR Calculation / GR Observer (Results Overview)

GR Observerlist

No.	Designation	Position [m]			Viewing sector [°]				Max
		X	Y	Z	Start	End	Increment	Slope angle	
509	GR Observer 509	0.679	45.619	1.500	0.0	360.0	15.0	-2.0	46 ²⁾
510	GR Observer 510	1.069	47.702	1.500	0.0	360.0	15.0	-2.0	46 ²⁾
511	GR Observer 511	1.459	49.786	1.500	0.0	360.0	15.0	-2.0	47 ²⁾
512	GR Observer 512	1.849	51.870	1.500	0.0	360.0	15.0	-2.0	46 ²⁾
513	GR Observer 513	2.239	53.954	1.500	0.0	360.0	15.0	-2.0	45 ²⁾
514	GR Observer 514	2.629	56.038	1.500	0.0	360.0	15.0	-2.0	43 ²⁾
515	GR Observer 515	3.019	58.121	1.500	0.0	360.0	15.0	-2.0	39 ²⁾
516	GR Observer 516	3.409	60.205	1.500	0.0	360.0	15.0	-2.0	37 ²⁾
517	GR Observer 517	-4.330	31.420	1.500	0.0	360.0	15.0	-2.0	37 ²⁾
518	GR Observer 518	-3.940	33.504	1.500	0.0	360.0	15.0	-2.0	42 ²⁾
519	GR Observer 519	-3.550	35.587	1.500	0.0	360.0	15.0	-2.0	45 ²⁾
520	GR Observer 520	-3.160	37.671	1.500	0.0	360.0	15.0	-2.0	47 ²⁾
521	GR Observer 521	-2.770	39.755	1.500	0.0	360.0	15.0	-2.0	47 ²⁾
522	GR Observer 522	-2.380	41.839	1.500	0.0	360.0	15.0	-2.0	48 ²⁾
523	GR Observer 523	-1.990	43.923	1.500	0.0	360.0	15.0	-2.0	47 ²⁾
524	GR Observer 524	-1.600	46.006	1.500	0.0	360.0	15.0	-2.0	46 ²⁾
525	GR Observer 525	-1.210	48.090	1.500	0.0	360.0	15.0	-2.0	47 ²⁾
526	GR Observer 526	-0.820	50.174	1.500	0.0	360.0	15.0	-2.0	48 ²⁾
527	GR Observer 527	-0.430	52.258	1.500	0.0	360.0	15.0	-2.0	47 ²⁾
528	GR Observer 528	-0.040	54.342	1.500	0.0	360.0	15.0	-2.0	46 ²⁾
529	GR Observer 529	0.350	56.426	1.500	0.0	360.0	15.0	-2.0	43 ²⁾
530	GR Observer 530	0.740	58.509	1.500	0.0	360.0	15.0	-2.0	39 ²⁾
531	GR Observer 531	1.130	60.593	1.500	0.0	360.0	15.0	-2.0	37 ²⁾
532	GR Observer 532	-6.436	31.814	1.500	0.0	360.0	15.0	-2.0	37 ²⁾
533	GR Observer 533	-6.046	33.898	1.500	0.0	360.0	15.0	-2.0	41 ²⁾
534	GR Observer 534	-5.656	35.982	1.500	0.0	360.0	15.0	-2.0	44 ²⁾
535	GR Observer 535	-5.266	38.065	1.500	0.0	360.0	15.0	-2.0	47 ²⁾
536	GR Observer 536	-4.876	40.149	1.500	0.0	360.0	15.0	-2.0	48 ²⁾
537	GR Observer 537	-4.486	42.233	1.500	0.0	360.0	15.0	-2.0	49 ²⁾
538	GR Observer 538	-4.096	44.317	1.500	0.0	360.0	15.0	-2.0	48 ²⁾
539	GR Observer 539	-3.706	46.401	1.500	0.0	360.0	15.0	-2.0	47 ²⁾
540	GR Observer 540	-3.316	48.484	1.500	0.0	360.0	15.0	-2.0	47 ²⁾
541	GR Observer 541	-2.926	50.568	1.500	0.0	360.0	15.0	-2.0	48 ²⁾
542	GR Observer 542	-2.536	52.652	1.500	0.0	360.0	15.0	-2.0	47 ²⁾
543	GR Observer 543	-2.147	54.736	1.500	0.0	360.0	15.0	-2.0	45 ²⁾
544	GR Observer 544	-1.757	56.820	1.500	0.0	360.0	15.0	-2.0	42 ²⁾

MIDSTREAM LIGHTING LIMITED
 WESSEX HOUSE
 1 CHESHAM STREET
 LONDON, SW 1X 8ND, UNITED KINGDOM

Operator MIDSTREAM LIGHTING LIMITED
 Telephone +44 (0)207 584 8310
 Fax
 e-Mail info@midstreamlighting.com

GR Calculation / GR Observer (Results Overview)

GR Observerlist

No.	Designation	Position [m]			Viewing sector [°]				Max
		X	Y	Z	Start	End	Increment	Slope angle	
545	GR Observer 545	-1.367	58.904	1.500	0.0	360.0	15.0	-2.0	39 ²⁾
546	GR Observer 546	-0.977	60.987	1.500	0.0	360.0	15.0	-2.0	38 ²⁾
547	GR Observer 547	-8.543	32.208	1.500	0.0	360.0	15.0	-2.0	37 ²⁾
548	GR Observer 548	-8.153	34.292	1.500	0.0	360.0	15.0	-2.0	38 ²⁾
549	GR Observer 549	-7.763	36.376	1.500	0.0	360.0	15.0	-2.0	41 ²⁾
550	GR Observer 550	-7.373	38.460	1.500	0.0	360.0	15.0	-2.0	44 ²⁾
551	GR Observer 551	-6.983	40.543	1.500	0.0	360.0	15.0	-2.0	46 ²⁾
552	GR Observer 552	-6.593	42.627	1.500	0.0	360.0	15.0	-2.0	48 ²⁾
553	GR Observer 553	-6.203	44.711	1.500	0.0	360.0	15.0	-2.0	47 ²⁾
554	GR Observer 554	-5.813	46.795	1.500	0.0	360.0	15.0	-2.0	46 ²⁾
555	GR Observer 555	-5.423	48.879	1.500	0.0	360.0	15.0	-2.0	47 ²⁾
556	GR Observer 556	-5.033	50.962	1.500	0.0	360.0	15.0	-2.0	47 ²⁾
557	GR Observer 557	-4.643	53.046	1.500	0.0	360.0	15.0	-2.0	45 ²⁾
558	GR Observer 558	-4.253	55.130	1.500	0.0	360.0	15.0	-2.0	42 ²⁾
559	GR Observer 559	-3.863	57.214	1.500	0.0	360.0	15.0	-2.0	41 ²⁾
560	GR Observer 560	-3.473	59.298	1.500	0.0	360.0	15.0	-2.0	40 ²⁾
561	GR Observer 561	-3.083	61.382	1.500	0.0	360.0	15.0	-2.0	39 ²⁾
562	GR Observer 562	-10.649	32.602	1.500	0.0	360.0	15.0	-2.0	35 ²⁾
563	GR Observer 563	-10.259	34.686	1.500	0.0	360.0	15.0	-2.0	37 ²⁾
564	GR Observer 564	-9.869	36.770	1.500	0.0	360.0	15.0	-2.0	38 ²⁾
565	GR Observer 565	-9.479	38.854	1.500	0.0	360.0	15.0	-2.0	40 ²⁾
566	GR Observer 566	-9.089	40.938	1.500	0.0	360.0	15.0	-2.0	42 ²⁾
567	GR Observer 567	-8.699	43.021	1.500	0.0	360.0	15.0	-2.0	45 ²⁾
568	GR Observer 568	-8.309	45.105	1.500	0.0	360.0	15.0	-2.0	45 ²⁾
569	GR Observer 569	-7.919	47.189	1.500	0.0	360.0	15.0	-2.0	45 ²⁾
570	GR Observer 570	-7.529	49.273	1.500	0.0	360.0	15.0	-2.0	44 ²⁾
571	GR Observer 571	-7.139	51.357	1.500	0.0	360.0	15.0	-2.0	43 ²⁾
572	GR Observer 572	-6.749	53.440	1.500	0.0	360.0	15.0	-2.0	42 ²⁾
573	GR Observer 573	-6.359	55.524	1.500	0.0	360.0	15.0	-2.0	41 ²⁾
574	GR Observer 574	-5.969	57.608	1.500	0.0	360.0	15.0	-2.0	40 ²⁾
575	GR Observer 575	-5.579	59.692	1.500	0.0	360.0	15.0	-2.0	39 ²⁾
576	GR Observer 576	-5.189	61.776	1.500	0.0	360.0	15.0	-2.0	38 ²⁾
577	GR Observer 577	-12.755	32.996	1.500	0.0	360.0	15.0	-2.0	36 ²⁾
578	GR Observer 578	-12.365	35.080	1.500	0.0	360.0	15.0	-2.0	37 ²⁾
579	GR Observer 579	-11.975	37.164	1.500	0.0	360.0	15.0	-2.0	38 ²⁾
580	GR Observer 580	-11.585	39.248	1.500	0.0	360.0	15.0	-2.0	39 ²⁾

MIDSTREAM LIGHTING LIMITED
 WESSEX HOUSE
 1 CHESHAM STREET
 LONDON, SW 1X 8ND, UNITED KINGDOM

Operator MIDSTREAM LIGHTING LIMITED
 Telephone +44 (0)207 584 8310
 Fax
 e-Mail info@midstreamlighting.com

GR Calculation / GR Observer (Results Overview)

GR Observerlist

No.	Designation	Position [m]			Viewing sector [°]				Max
		X	Y	Z	Start	End	Increment	Slope angle	
581	GR Observer 581	-11.195	41.332	1.500	0.0	360.0	15.0	-2.0	43 ²⁾
582	GR Observer 582	-10.805	43.416	1.500	0.0	360.0	15.0	-2.0	45 ²⁾
583	GR Observer 583	-10.415	45.499	1.500	0.0	360.0	15.0	-2.0	45 ²⁾
584	GR Observer 584	-10.025	47.583	1.500	0.0	360.0	15.0	-2.0	43 ²⁾
585	GR Observer 585	-9.635	49.667	1.500	0.0	360.0	15.0	-2.0	44 ²⁾
586	GR Observer 586	-9.245	51.751	1.500	0.0	360.0	15.0	-2.0	44 ²⁾
587	GR Observer 587	-8.855	53.835	1.500	0.0	360.0	15.0	-2.0	43 ²⁾
588	GR Observer 588	-8.465	55.918	1.500	0.0	360.0	15.0	-2.0	40 ²⁾
589	GR Observer 589	-8.075	58.002	1.500	0.0	360.0	15.0	-2.0	38 ²⁾
590	GR Observer 590	-7.685	60.086	1.500	0.0	360.0	15.0	-2.0	37 ²⁾
591	GR Observer 591	-7.295	62.170	1.500	0.0	360.0	15.0	-2.0	37 ²⁾
592	GR Observer 592	-14.861	33.391	1.500	0.0	360.0	15.0	-2.0	35 ²⁾
593	GR Observer 593	-14.471	35.474	1.500	0.0	360.0	15.0	-2.0	36 ²⁾
594	GR Observer 594	-14.081	37.558	1.500	0.0	360.0	15.0	-2.0	39 ²⁾
595	GR Observer 595	-13.691	39.642	1.500	0.0	360.0	15.0	-2.0	42 ²⁾
596	GR Observer 596	-13.302	41.726	1.500	0.0	360.0	15.0	-2.0	44 ²⁾
597	GR Observer 597	-12.912	43.810	1.500	0.0	360.0	15.0	-2.0	45 ²⁾
598	GR Observer 598	-12.522	45.894	1.500	0.0	360.0	15.0	-2.0	44 ²⁾
599	GR Observer 599	-12.132	47.977	1.500	0.0	360.0	15.0	-2.0	43 ²⁾
600	GR Observer 600	-11.742	50.061	1.500	0.0	360.0	15.0	-2.0	45 ²⁾
601	GR Observer 601	-11.352	52.145	1.500	0.0	360.0	15.0	-2.0	46 ²⁾
602	GR Observer 602	-10.962	54.229	1.500	0.0	360.0	15.0	-2.0	45 ²⁾
603	GR Observer 603	-10.572	56.313	1.500	0.0	360.0	15.0	-2.0	42 ²⁾
604	GR Observer 604	-10.182	58.396	1.500	0.0	360.0	15.0	-2.0	39 ²⁾
605	GR Observer 605	-9.792	60.480	1.500	0.0	360.0	15.0	-2.0	37 ²⁾
606	GR Observer 606	-9.402	62.564	1.500	0.0	360.0	15.0	-2.0	36 ²⁾
607	GR Observer 607	-16.968	33.785	1.500	0.0	360.0	15.0	-2.0	33 ²⁾
608	GR Observer 608	-16.578	35.869	1.500	0.0	360.0	15.0	-2.0	34 ²⁾
609	GR Observer 609	-16.188	37.952	1.500	0.0	360.0	15.0	-2.0	38 ²⁾
610	GR Observer 610	-15.798	40.036	1.500	0.0	360.0	15.0	-2.0	41 ²⁾
611	GR Observer 611	-15.408	42.120	1.500	0.0	360.0	15.0	-2.0	42 ²⁾
612	GR Observer 612	-15.018	44.204	1.500	0.0	360.0	15.0	-2.0	43 ²⁾
613	GR Observer 613	-13.458	52.539	1.500	0.0	360.0	15.0	-2.0	42 ²⁾
614	GR Observer 614	-13.068	54.623	1.500	0.0	360.0	15.0	-2.0	42 ²⁾
615	GR Observer 615	-12.678	56.707	1.500	0.0	360.0	15.0	-2.0	40 ²⁾
616	GR Observer 616	-12.288	58.791	1.500	0.0	360.0	15.0	-2.0	38 ²⁾

MIDSTREAM LIGHTING LIMITED
WESSEX HOUSE
1 CHESHAM STREET
LONDON, SW 1X 8ND, UNITED KINGDOM

Operator MIDSTREAM LIGHTING LIMITED
Telephone +44 (0)207 584 8310
Fax
e-Mail info@midstreamlighting.com

GR Calculation / GR Observer (Results Overview)

GR Observerlist

No.	Designation	Position [m]			Start	Viewing sector [°]			Max
		X	Y	Z		End	Increment	Slope angle	
617	GR Observer 617	-11.898	60.874	1.500	0.0	360.0	15.0	-2.0	36 ²⁾
618	GR Observer 618	-11.508	62.958	1.500	0.0	360.0	15.0	-2.0	35 ²⁾

2) The calculated equivalent veil luminance of the environment is based on the assumption of a complete diffuse reflection behavior of the environment (acc. EN 12464-2).